

2011 North Dakota Energy Codes

Carl Pedersen
Energy Educator
NDSU Extension Service
Ag and Biosystems Engineering

The following training is brought to you by the North Dakota Association of Builders courtesy of the North Dakota Department of Commerce: Office of Renewable Energy & Energy Efficiency in cooperation the North Dakota State University Extension Service.

The following information is an interpretation of information contained in the International Residential Code and the International Energy Conservation Code. NDSU, nor any its employees are responsible for the accuracy, completeness, or interpretation of any information contained.



Acknowledgement –

This material is based upon work supported by the US Department of Energy State Energy Program 08 NT43202

Disclaimer –

The report was prepared as an account of work sponsored by an agency of the United States Government. Neither the United States Government nor any agency thereof, nor any of their employees, makes any warranty, express or implied, or assume any legal liability or responsibility for the accuracy, completeness, or usefulness of any information, apparatus, product, or process disclosed, or represents that its use would not infringe privately owned rights. Reference herein to any specific commercial product, process, or service by trade name, trademark, manufacturer, or otherwise does not necessarily constitute or imply its endorsement, recommendation, or favoring by the United States Government or any agency thereof. The views and opinions of authors expressed herein do not necessarily state of reflect those of the United States Government or any agency thereof.



Today's Topics

- Building Science
- Scope
- IRC vs IECC
- Specific Requirements
- Performance alternative
- Documentation

Building Science

- Heat Loss
 - Warm to cold
 - Path of least resistance

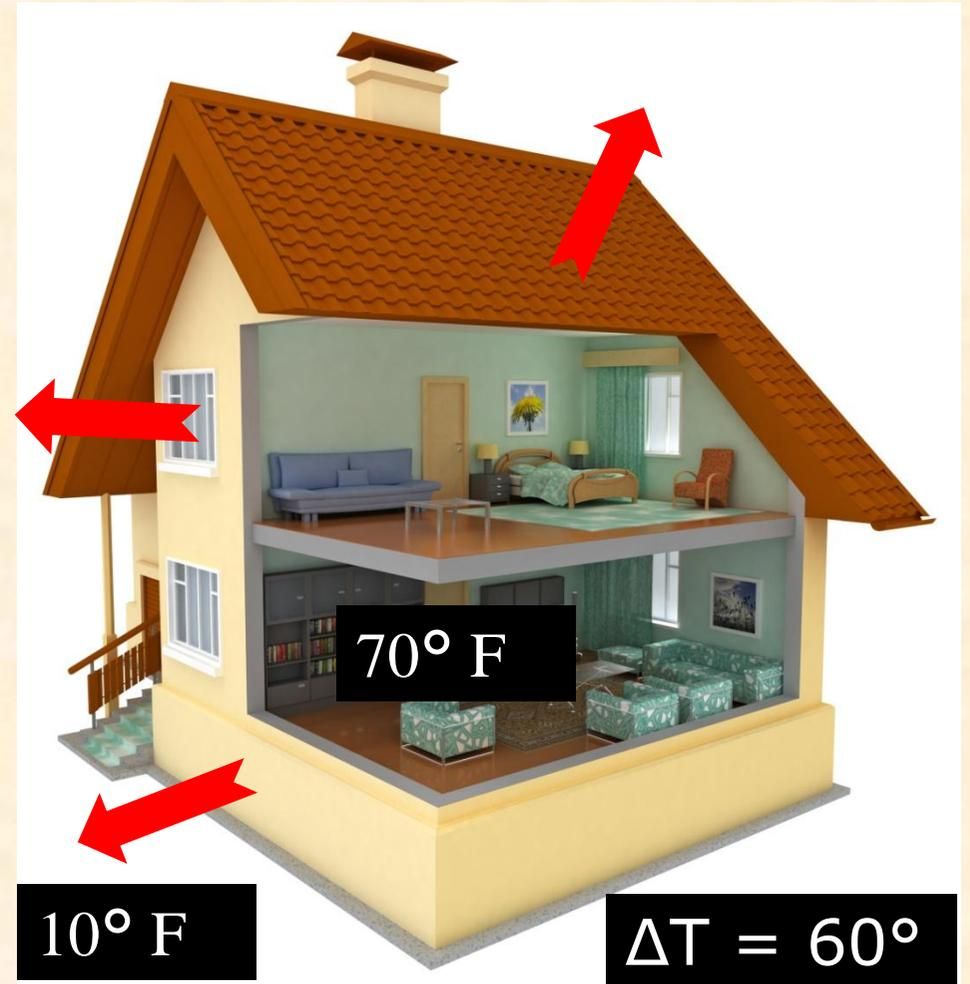

Heat Transfer

- Conduction – collisions (R-value)
- Convection – currents
- Radiation – waves



Air Movement

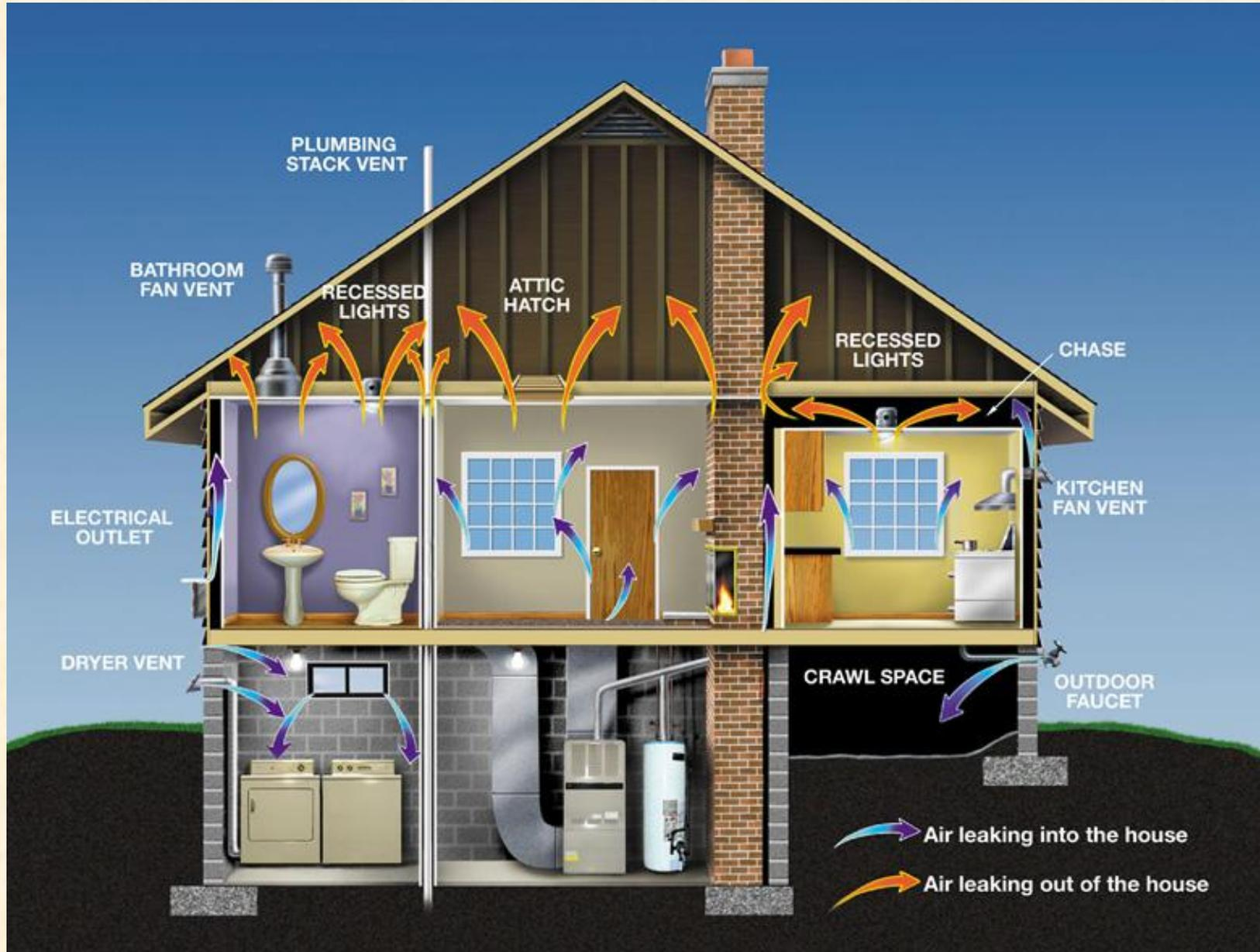

Moisture Movement

- More to less
- Indoor – 40-60%
- Wet soil 100%
- Building materials
 - Concrete
 - Wood



Which way is the foundation going to dry?

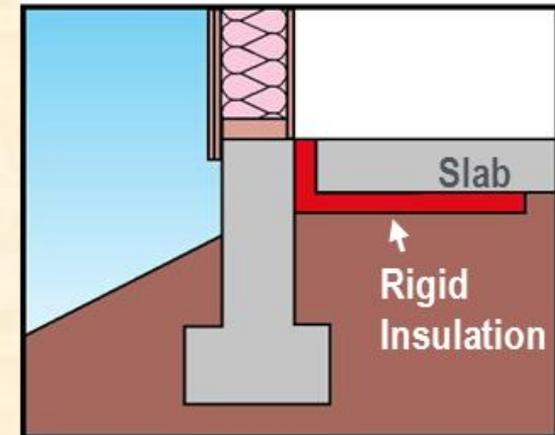
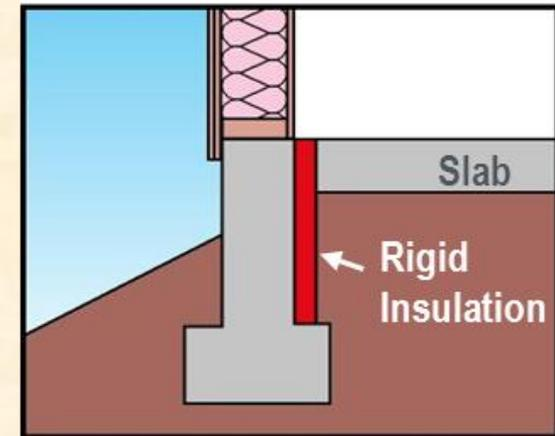
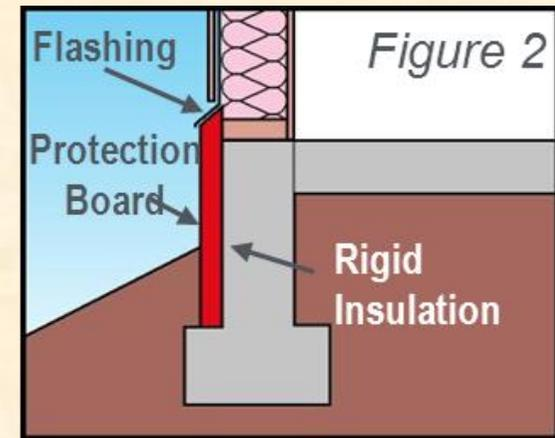

International Codes

N1101.2

401.2

North Dakota Amendments

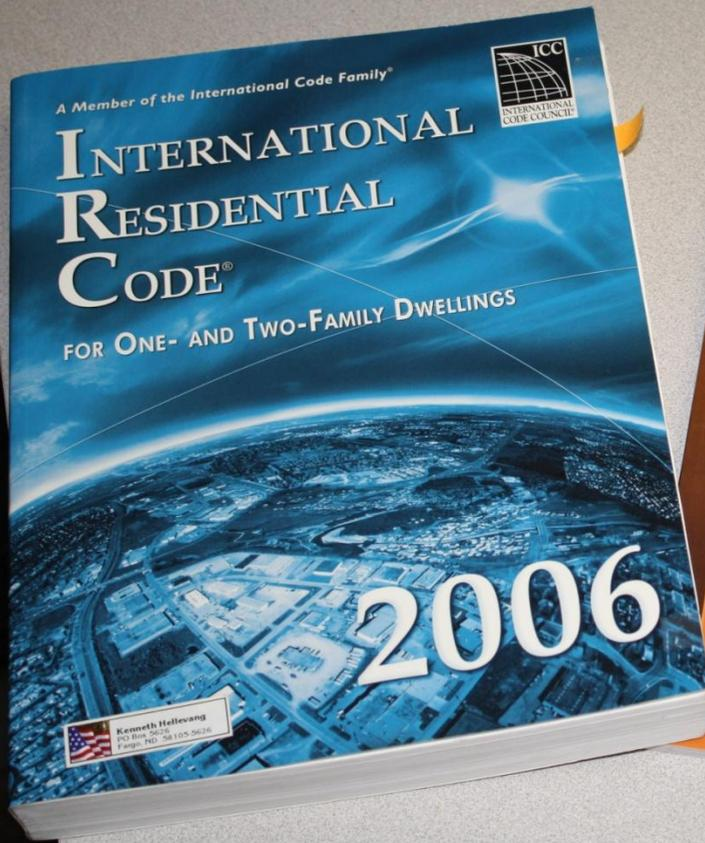

North Dakota State Building Code



Effective
January 1, 2011

Department of Commerce
Division of Community Services
1600 East Century Avenue, Suite 2
PO Box 2057
Bismarck, ND 58502-2057
(701) 328-5300 Phone
(701) 328-2308 Fax

ALTERNATIVE FORMATS FOR PERSONS WITH DISABILITIES
ARE AVAILABLE UPON REQUEST

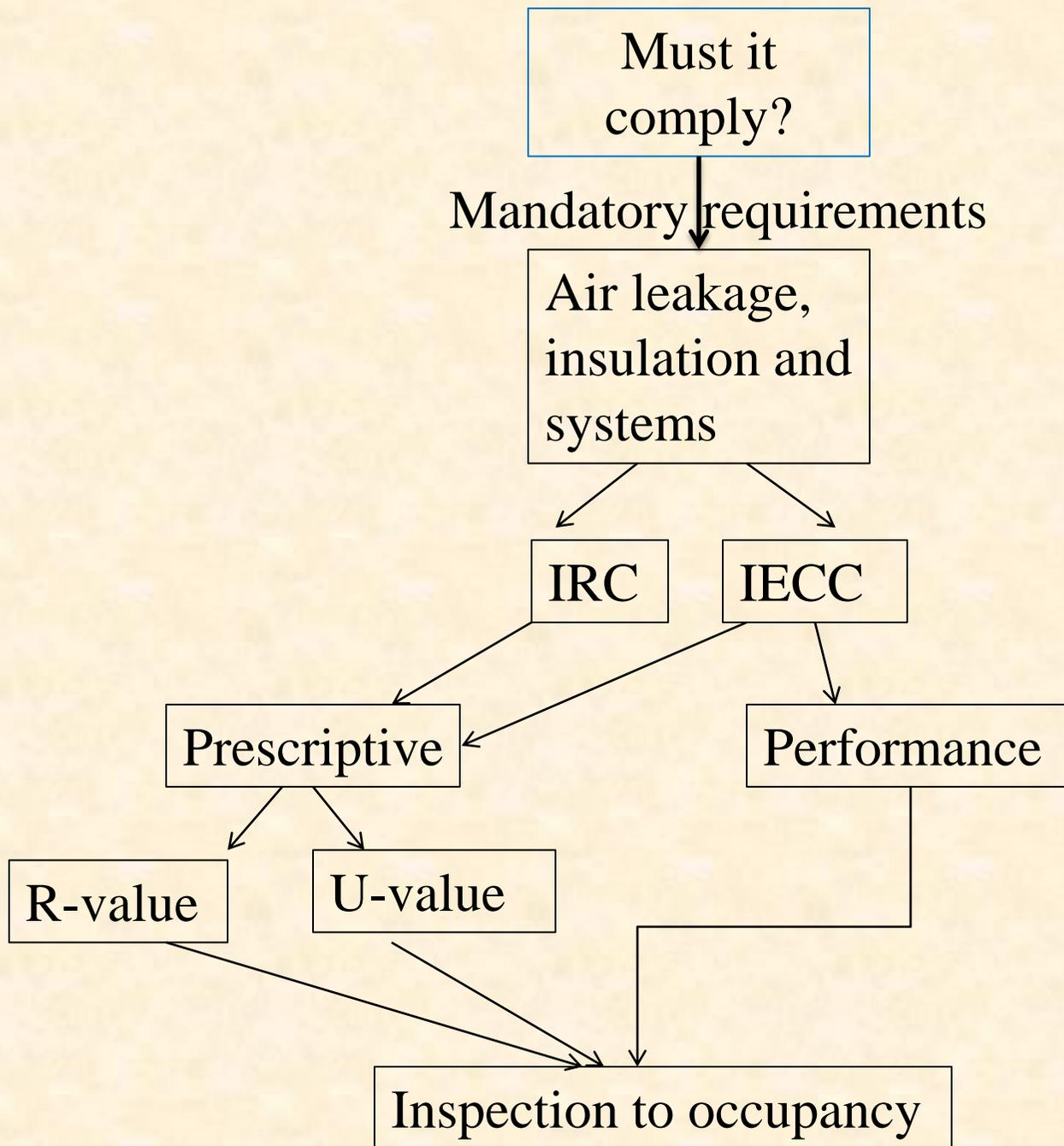

Varies by Jurisdiction

- Building codes are not consistent throughout North Dakota
- Check with local code officials!!!!!!
- Information covered in this presentation is for the North Dakota State Building Code

IRC and IECC

- IECC addresses only energy
- IRC addresses all topics (structural, plumbing, etc.)
 - Allows builder to carry only one code book
 - Chapter 11 covers energy efficiency
- IRC allows compliance with IECC as an alternative to Chapter 11
- IECC addresses both residential and commercial; IRC addresses subset of residential detached one- and two-family dwellings and townhouses 3 stories or fewer
- Energy requirements in IRC and IECC almost identical
 - IRC has less stringent foundation requirements in northern zones

IRC and IECC

- IRC has amendments in North Dakota, IECC does not.

IRC	IECC
Walls R-19	Walls R-20 (Zone 6) or R-21 (zone 7)
No duct testing requirement	Duct leakage testing required
No programmable thermostat requirement	Programmable thermostat required
No high efficacy light requirement	50% high efficacy light requirement

Scope – IRC N1101.1

Residential Buildings

- One and two family homes
- Separate egress
- Less than 3 stories above grade



Scope – IECC

1263068



1831523

Residential Buildings:

- IECC has one- and two-family R-2, R-3, R-4 ≤ 3 stories
- All buildings that are not “residential” by definition are “commercial”
- Includes additions, alterations, renovations and repairs

Quiz

Is this
residential?

IRC or
IECC?



Quiz

Is this
residential?
IRC or
IECC?



Scope –Exempted Buildings

- Very low energy use buildings (<3.4 Btu/h-ft² or 1 watt/ft²)
- Buildings (or portions of) that are neither heated nor cooled
- Existing buildings (Section 101.4.1 IECC)
 - Electrical power, lighting, and mechanical systems still apply
- Buildings designated as historic (Section 101.4.2 IECC)

Scope - Additions, Alterations, Renovations, Repairs



- Code applies to any new construction
- Unaltered portion(s) do not need to comply
- Additions can comply alone or in combination with existing building
- Replacement fenestration that includes both glazing and sash must meet
 - U-factors in all Zones

Scope - Additions, Alterations, Renovations, Repairs

- Exceptions
 - Storm windows over existing fenestration
 - Glass-only replacements
 - Exposed, existing ceiling, wall or floor cavities if already filled with insulation
 - Where existing roof, wall or floor cavity isn't exposed



Image Courtesy of DOE NREL image 13604

Scope - Additions, Alterations, Renovations, Repairs

- Exceptions (IECC)
 - Reroofing for roofs where neither sheathing nor insulation exposed
 - Insulate above or below the sheathing
 - Roofs without insulation in the cavity
 - Sheathing or insulation is exposed
 - Provided installed interior lighting power isn't increased and
 - < 50% of luminaires in a space are replaced (IECC)
 - Only bulb and ballast within existing luminaires in a space are replaced

Space Conditioning

- Non-conditioned to conditioned.

Examples:

- Converting a garage to a family room
- Heating a basement

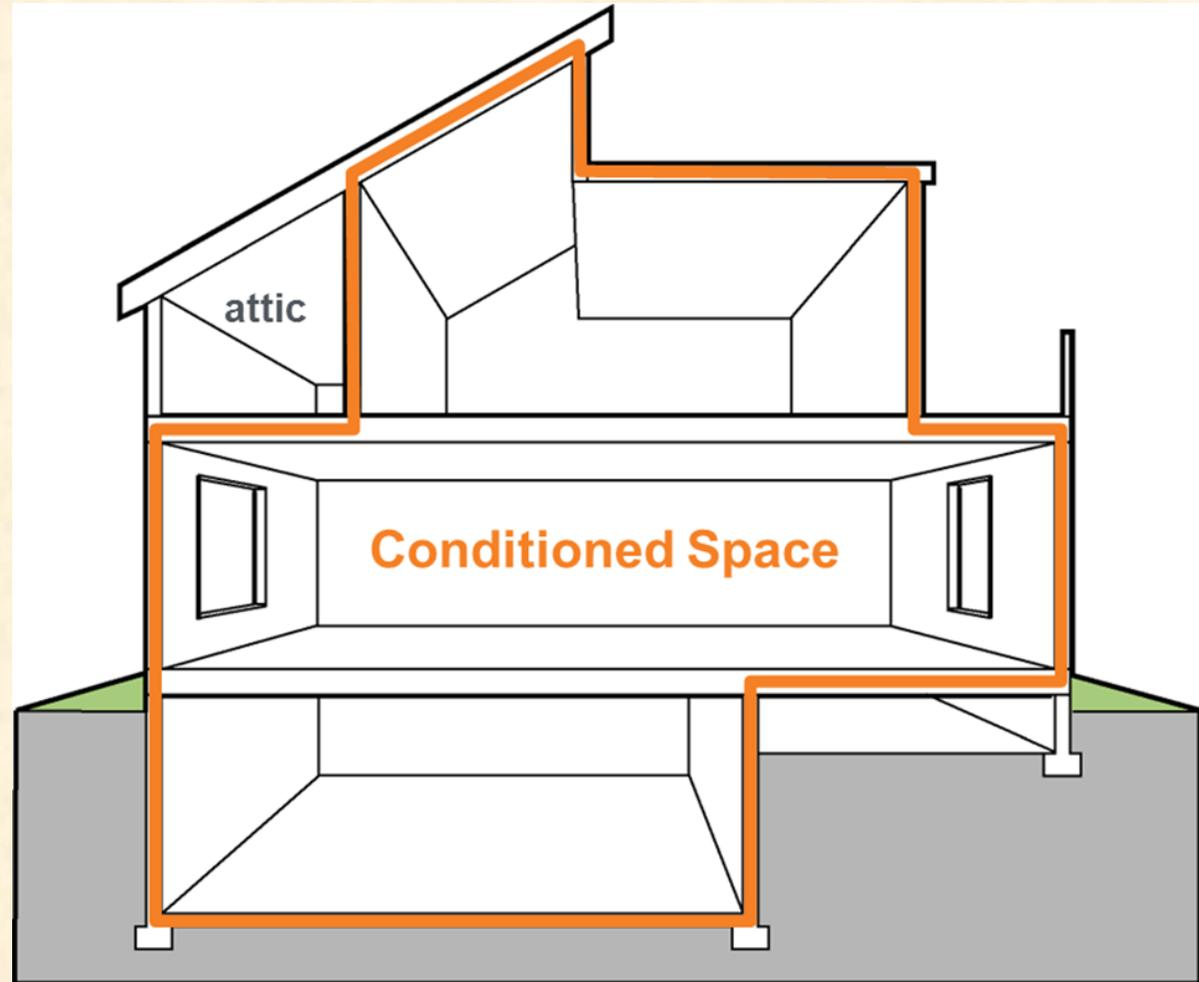

Scope - Mixed Use Buildings IECC

- Treat the residential occupancy under the applicable residential code
- Treat the commercial occupancy under the commercial code

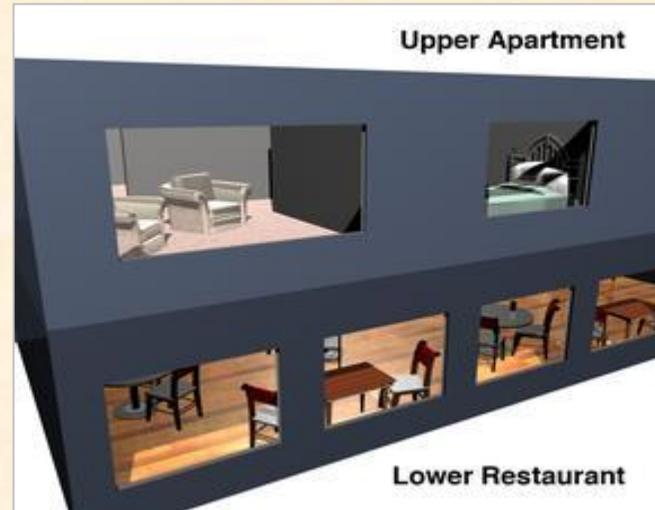

Quiz

Is this
residential?
IRC or
IECC?



Overview of Structure

Climate-Specific Requirements:

- Foundations
 - Basements
 - Slabs
 - Crawlspace
- Above grade walls
- Skylights, windows, and doors
- Roofs

Universal Requirements (apply everywhere):

- Duct insulation and sealing
- Infiltration control

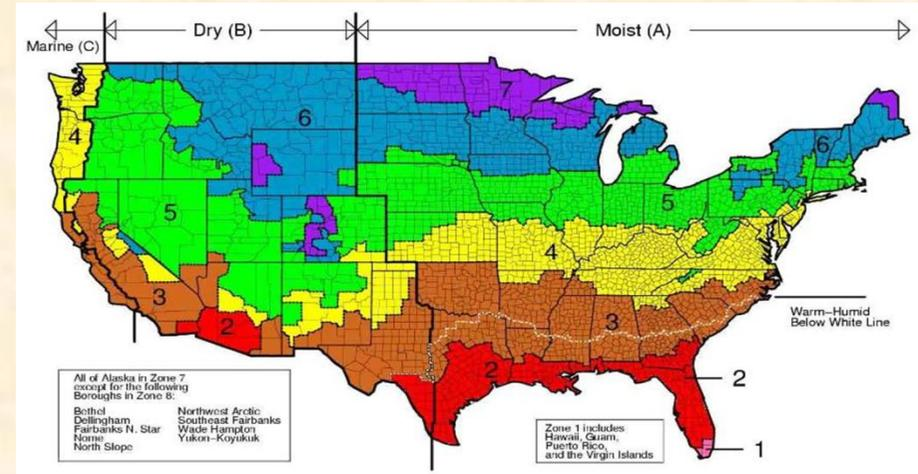

North Dakota Climate Zones

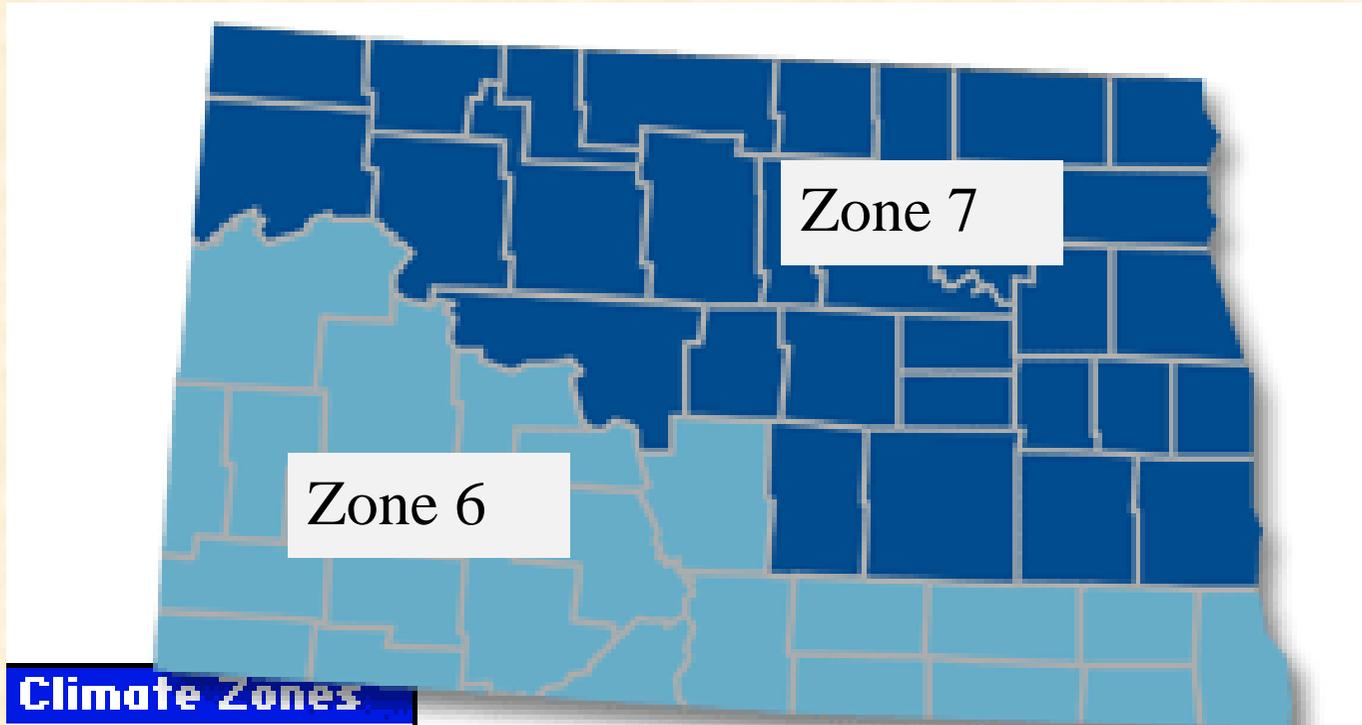

Overview of Residential Code Requirements

- Focus is on building envelope
 - Ceilings, walls, windows, floors, foundations
 - Sets insulation and fenestration levels
 - Infiltration control - caulk and seal to prevent air leaks
- Ducts – seal and insulate
- Limited space heating, air conditioning, and water heating requirements
 - Federal law sets most equipment efficiency requirements, not the I-codes
- No appliance requirements
- Lighting equipment – 50% of lamps to be high-efficacy lamps. **Amended Out!!!!!!!**

Insulation and Fenestration Requirements by Climate Zone

Table N1102.1(IRC) or 402.1.1(IECC)

Insulation and Fenestration Requirements by Component

CLIMATE ZONE	FENESTRATION U-FACTOR ^b	SKYLIGHT ^b U-FACTOR	GLAZED FENESTRATION ^{b,e} SHGC	CEILING R-VALUE	WOOD FRAME WALL R-VALUE	MASS WALL R-VALUE ⁱ	FLOOR R-VALUE	BASEMENT ^c WALL R-VALUE	SLAB ^d R-VALUE & DEPTH	CRAWL SPACE ^c WALL R-VALUE
1	1.20	0.75	0.30	30	13	3 / 4	13	0	0	0
2	0.65 ^j	0.75	0.30	30	13	4 / 6	13	0	0	0
3	0.50 ^j	0.65	0.30	30	13	5 / 8	19	5 / 13 ^f	0	5 / 13
4 except Marine	0.35	0.60	NR	38	13	5 / 10	19	10 / 13	10, 2ft	10 / 13
5 and Marine 4	0.35	0.60	NR	38	20 or 13+5 ^h	13 / 17	30 ^g	10 / 13	10, 2 ft	10 / 13
6	0.35	0.60	NR	49	20 or 13+5 ^h	15 / 19	30 ^g	15 / 19	10, 4 ft	10 / 13
7 and 8	0.35	0.60	NR	49	21	19 / 21	38 ^g	15 / 19	10, 4 ft	10 / 13

^a *R*-values are minimums, *U*-factors and SHGC are maximums, R-19 batts compressed into a nominal 2 x 6 framing cavity such that the *R*-value is reduced by R-1 or more shall be marked with the compressed batt *R*-value in addition to the full thickness *R*-value.

^b The fenestration *U*-factor column excludes skylights. The SHGC column applies to all glazed fenestration.

^c “15/19” means R-15 continuous insulated sheathing on the interior or exterior of the home or R-19 cavity insulation at the interior of the basement wall. “15/19” shall be permitted to be met with R-13 cavity insulation on the interior of the basement wall plus R-5 continuous insulated sheathing on the interior or exterior of the home. “10/13” means R-10 continuous insulated sheathing on the interior or exterior of the home or R-13 cavity insulation at the interior of the basement wall.

^d R-5 shall be added to the required slab edge *R*-values for heated slabs. Insulation depth shall be the depth of the footing or 2 feet, whichever is less in Zones 1 through 3 for heated slabs.

^e There are no SHGC requirements in the Marine Zone.

^f Basement wall insulation is not required in warm-humid locations as defined by Figure 301.1 and Table 301.1.

^g Or insulation sufficient to fill the framing cavity, R-19 minimum.

^h “13+5” means R-13 cavity insulation plus R-5 insulated sheathing. If structural sheathing covers 25 percent or less of the exterior, insulating sheathing is not required where structural sheathing is used. If structural sheathing covers more than 25 percent of exterior, structural sheathing shall be supplemented with insulated sheathing of at least R-2.

ⁱ The second *R*-value applies when more than half the insulation is on the interior of the mass wall.

^j For impact rated fenestration complying with Section R301.2.1.2 of the *IRC* or Section 1608.1.2 of the *IBC*, maximum *U*-factor shall be 0.75 in Zone 2 and 0.65 in Zone 3.

North Dakota IRC Amendments

- Table R1102.1 Revise as follows:
For climate zones 6,7, and 8, under “Wood Frame Wall R-Value” column, delete listed values and replace with R-19 in both cases.
- Section N1103.1.1 - Section N1103.1.1 is hereby deleted in its entirety.
Removes requirement for programmable thermostats

- Section N1103.2.2 Revise as follows:

N1103.2.2 Sealing. Ducts, air handlers, filter boxes and building cavities used as ducts shall be sealed. Joints and seams shall comply with Section M1601.4.

Removes duct testing requirement

- Section N1104.1 - Section N1104.1 is hereby deleted in its entirety.
Removes requirement for high efficacy lights (CFLs,etc)

Insulation and Fenestration Requirements by Climate Zone

Table N1102.1(IRC) or 402.1.1(IECC)

Insulation and Fenestration Requirements by Component

CLIMATE ZONE	FENESTRATION U-FACTOR ^b	SKYLIGHT ^b U-FACTOR	GLAZED FENESTRATION ^{b,e} SHGC	CEILING R-VALUE	WOOD FRAME WALL R-VALUE	MASS WALL R-VALUE ⁱ	FLOOR R-VALUE	BASEMENT ^c WALL R-VALUE	SLAB ^d R-VALUE & DEPTH	CRAWL SPACE ^c WALL R-VALUE
1	1.20	0.75	0.30	30	13	3 / 4	13	0	0	0
2	0.65 ^j	0.75	0.30	30	13	4 / 6	13	0	0	0
3	0.50 ^j	0.65	0.30	30	13	5 / 8	19	5 / 13 ^f	0	5 / 13
4 except Marine	0.35	0.60	NR	38	13	5 / 10	19	10 / 13	10, 2ft	10 / 13
5 and Marine 4	0.35	0.60	NR	38	20 or 13+5 ^h	13 / 17	30 ^g	10 / 13	10, 2 ft	10 / 13
6	0.35	0.60	NR	49	19	15 / 19	30 ^g	15 / 19	10, 4 ft	10 / 13
7 and 8	0.35	0.60	NR	49	19	19 / 21	38 ^g	15 / 19	10, 4 ft	10 / 13

^a *R*-values are minimums, *U*-factors and SHGC are maximums, R-19 batts compressed into a nominal 2 x 6 framing cavity such that the *R*-value is reduced by R-1 or more shall be marked with the compressed batt *R*-value in addition to the full thickness *R*-value.

^b The fenestration *U*-factor column excludes skylights. The SHGC column applies to all glazed fenestration.

^c “15/19” means R-15 continuous insulated sheathing on the interior or exterior of the home or R-19 cavity insulation at the interior of the basement wall. “15/19” shall be permitted to be met with R-13 cavity insulation on the interior of the basement wall plus R-5 continuous insulated sheathing on the interior or exterior of the home. “10/13” means R-10 continuous insulated sheathing on the interior or exterior of the home or R-13 cavity insulation at the interior of the basement wall.

^d R-5 shall be added to the required slab edge *R*-values for heated slabs. Insulation depth shall be the depth of the footing or 2 feet, whichever is less in Zones 1 through 3 for heated slabs.

^e There are no SHGC requirements in the Marine Zone.

^f Basement wall insulation is not required in warm-humid locations as defined by Figure 301.1 and Table 301.1.

^g Or insulation sufficient to fill the framing cavity, R-19 minimum.

^h “13+5” means R-13 cavity insulation plus R-5 insulated sheathing. If structural sheathing covers 25 percent or less of the exterior, insulating sheathing is not required where structural sheathing is used. If structural sheathing covers more than 25 percent of exterior, structural sheathing shall be supplemented with insulated sheathing of at least R-2.

ⁱ The second *R*-value applies when more than half the insulation is on the interior of the mass wall.

^j For impact rated fenestration complying with Section R301.2.1.2 of the *IRC* or Section 1608.1.2 of the *IBC*, maximum *U*-factor shall be 0.75 in Zone 2 and 0.65 in Zone 3.

Prescriptive R-values

**TABLE N1102.1
INSULATION AND FENESTRATION REQUIREMENTS BY COMPONENT^a**

CLIMATE ZONE	FENESTRATION U-FACTOR	SKYLIGHT ^b U-FACTOR	GLAZED FENESTRATION SHGC	CEILING R-VALUE	WOOD FRAME WALL R-VALUE	MASS WALL R-VALUE ^k	FLOOR R-VALUE	BASEMENT ^c WALL R-VALUE	SLAB ^d R-VALUE AND DEPTH	CRAWL SPACE ^c WALL R-VALUE
6	0.35	0.60	NR	49	19	15/19	30 ^g	10/13	10, 4 ft	10/13
7 and 8	0.35	0.60	NR	49	19	19/21	30 ^g	10/13	10, 4 ft	10/13

Pg 468

**TABLE 402.1.1
INSULATION AND FENESTRATION REQUIREMENTS BY COMPONENT^a**

CLIMATE ZONE	FENESTRATION U-FACTOR ^b	SKYLIGHT ^b U-FACTOR	GLAZED FENESTRATION SHGC ^{b, e}	CEILING R-VALUE	WOOD FRAME WALL R-VALUE	MASS WALL R-VALUE ⁱ	FLOOR R-VALUE	BASEMENT ^c WALL R-VALUE	SLAB ^d R-VALUE & DEPTH	CRAWL SPACE ^c WALL R-VALUE
6	0.35	0.60	NR	49	20 or 13+5 ^h	15/19	30 ^g	15/19	10, 4 ft	10/13
7 and 8	0.35	0.60	NR	49	21	19/21	38 ^g	15/19	10, 4 ft	10/13

Pg 27

Envelope Insulation N1101.4

- Mark each piece greater than 12” --- or ---
- Certificate
 - Type
 - Manufacturer
 - R-value for each piece of building envelope
- Sign, date and Post

Envelope Certification N1101.4

- Blown
- Installer must certify
 - Thickness (pre-post)
 - R-value
 - Coverage
 - Amount used
- Markers (N1101.4.1)
- Sign, date and post

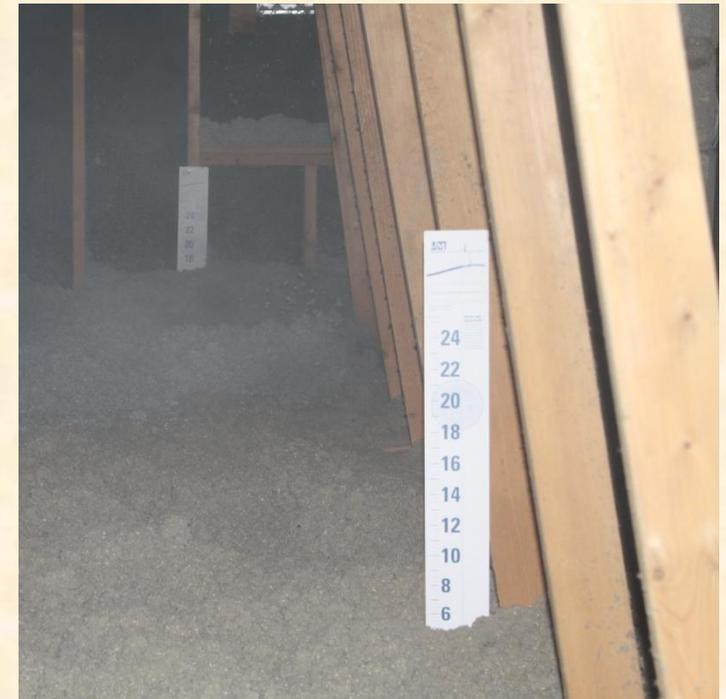

Fenestration labeling N1101.5

- NFRC label
- Default tables for fenestrations
- Used with no identifications

		World's Best Window Co.	
		Millennium 2000+ Vinyl-Clad Wood Frame Double Glazing • Argon Fill • Low E Product Type: Vertical Slider	
ENERGY PERFORMANCE RATINGS			
U-Factor (U.S./I-P)		Solar Heat Gain Coefficient	
0.35		0.32	
ADDITIONAL PERFORMANCE RATINGS			
Visible Transmittance		Air Leakage (U.S./I-P)	
0.51		0.2	
Condensation Resistance		—————	
51			
<small>Manufacturer certifies that these ratings conform to applicable NFRC procedures for determining window product performance. NFRC ratings are determined for a fixed set of environmental conditions and a specific product size. Consult manufacturer's literature for other product performance information. www.nfrc.org</small>			

Installation N1101.7

- According to manufacturers instructions
- N1101.7.1 – protection of exterior basement insulation
 - 6 inches below grade

Certificate N1101.9

- Permanently posted on or in the electrical distribution panel
- Don't cover or obstruct the visibility of other required labels
- Includes the following:
 - R-values walls, roof/ceiling, foundation/basement/slab
 - Thermal envelope**
 - U-factors for fenestration
 - HVAC efficiencies and types
 - SWH equipment

Certificate (cont'd)

- Certificate lists “gas-fired unvented room heater”, “electric furnace”, or “baseboard electric heater”, rather than listing an efficiency for those heating types

Insulation and Fenestration Requirements

N1102.1

- Meet requirements of Table N1102.1

TABLE N1102.1
INSULATION AND FENESTRATION REQUIREMENTS BY COMPONENT^a

CLIMATE ZONE	FENESTRATION U-FACTOR	SKYLIGHT ^b U-FACTOR	GLAZED FENESTRATION SHGC	CEILING R-VALUE	WOOD FRAME WALL R-VALUE	MASS WALL R-VALUE ^k	FLOOR R-VALUE	BASEMENT ^c WALL R-VALUE	SLAB ^d R-VALUE AND DEPTH	CRAWL SPACE ^c WALL R-VALUE
6	0.35	0.60	NR	49	19	15/19	30 ^e	10/13	10, 4 ft	10/13
7 and 8	0.35	0.60	NR	49	19	19/21	30 ^e	10/13	10, 4 ft	10/13

U-Factor and Total UA Alternatives N1102.1.2-.3

- U-factor Alternative (Assemblies) $U = 1/R$
 - Similar to Prescriptive R-Value but uses U-factors instead.
 - Allows for innovative or less common construction techniques such as structural insulated panels or advanced framing
 - Allows no trade offs between building components
- Total UA Alternative
 - Same as U-factor alternative but allows trade-offs across all envelope components
 - Primary approach used in RES*check* software

UA – U factor x area of assembly

Locations with Window SHGC Requirements

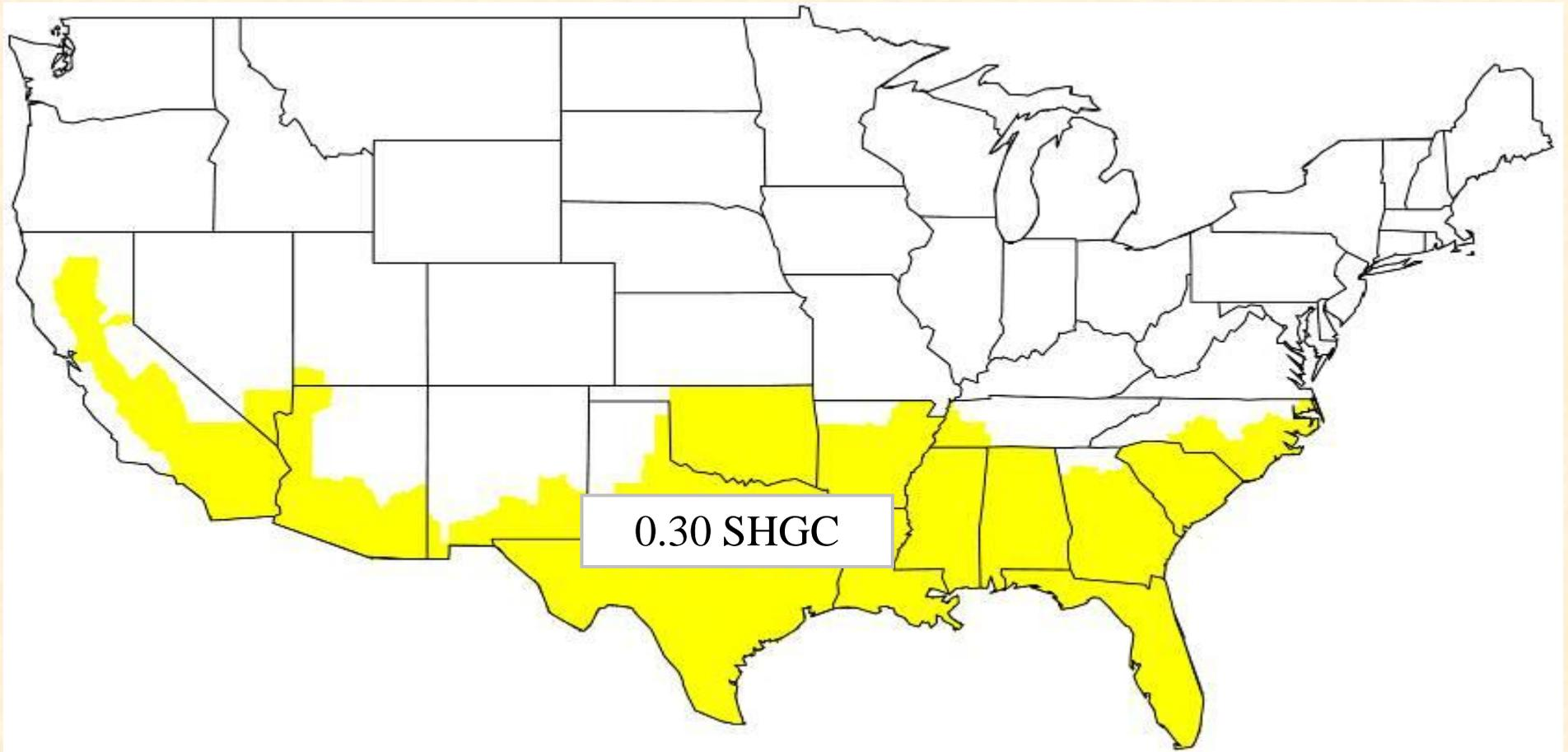

Requirements by Climate Zone (U-Factor Table)

Table N1102.1.1 (IRC) -402.1.3(IECC)
Equivalent U-Factors

CLIMATE ZONE	FENESTRATION U-FACTOR	SKYLIGHT U-FACTOR	CEILING U-FACTOR	FRAME WALL U-FACTOR	MASS WALL U-FACTOR ^b	FLOOR U-FACTOR	BASEMENT WALL U-FACTOR ^d	CRAWL SPACE WALL U-FACTOR ^c
1	1.20	0.75	0.035	0.082	0.197	0.064	0.360	0.477
2	0.65	0.75	0.035	0.082	0.165	0.064	0.360	0.477
3	0.50	0.65	0.035	0.082	0.141	0.047	0.091 ^c	0.136
4 except Marine	0.35	0.60	0.030	0.082	0.141	0.047	0.059	0.065
5 and Marine 4	0.35	0.60	0.030	0.057	0.082	0.033	0.059	0.065
6	0.35	0.60	0.026	0.057	0.060	0.033	0.050	0.065
7 and 8	0.35	0.60	0.026	0.057	0.057	0.028	0.050	0.065

^a Nonfenestration *U*-factors shall be obtained from measurement, calculation or an approved source.

^b When more than half the insulation is on the interior, the mass wall *U*-factors shall be a maximum of 0.17 in Zone 1, 0.14 in Zone 2, 0.12 in Zone 3, 0.10 in Zone 4 except Marine, and the same as the frame wall *U*-factor in Marine Zone 4 and Zones 5 through 8.

^c Basement wall *U*-factor of 0.360 in warm-humid locations as defined by Figure 301.1 and Table 301.2.

Compliance - Three Options

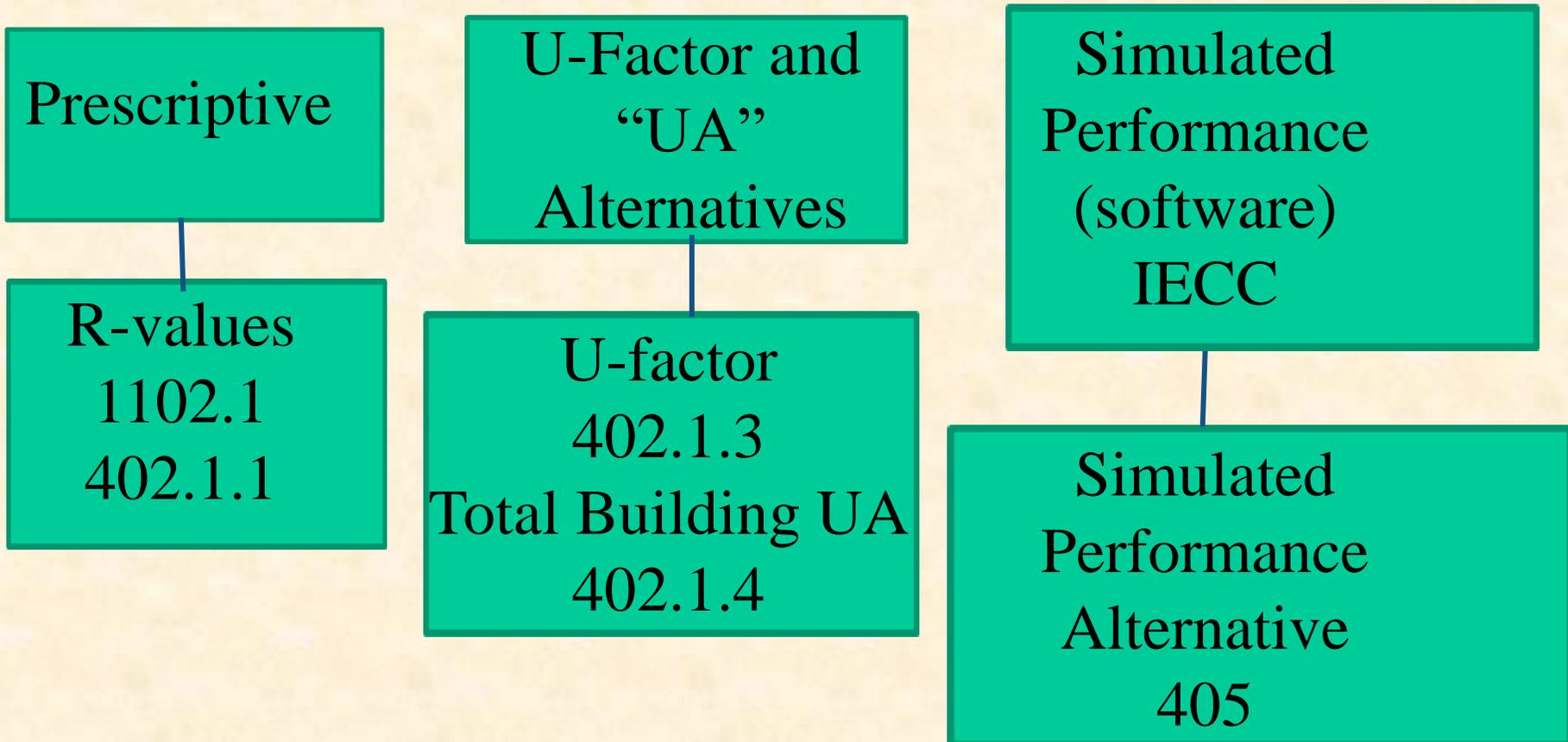

Code Compliance Tools

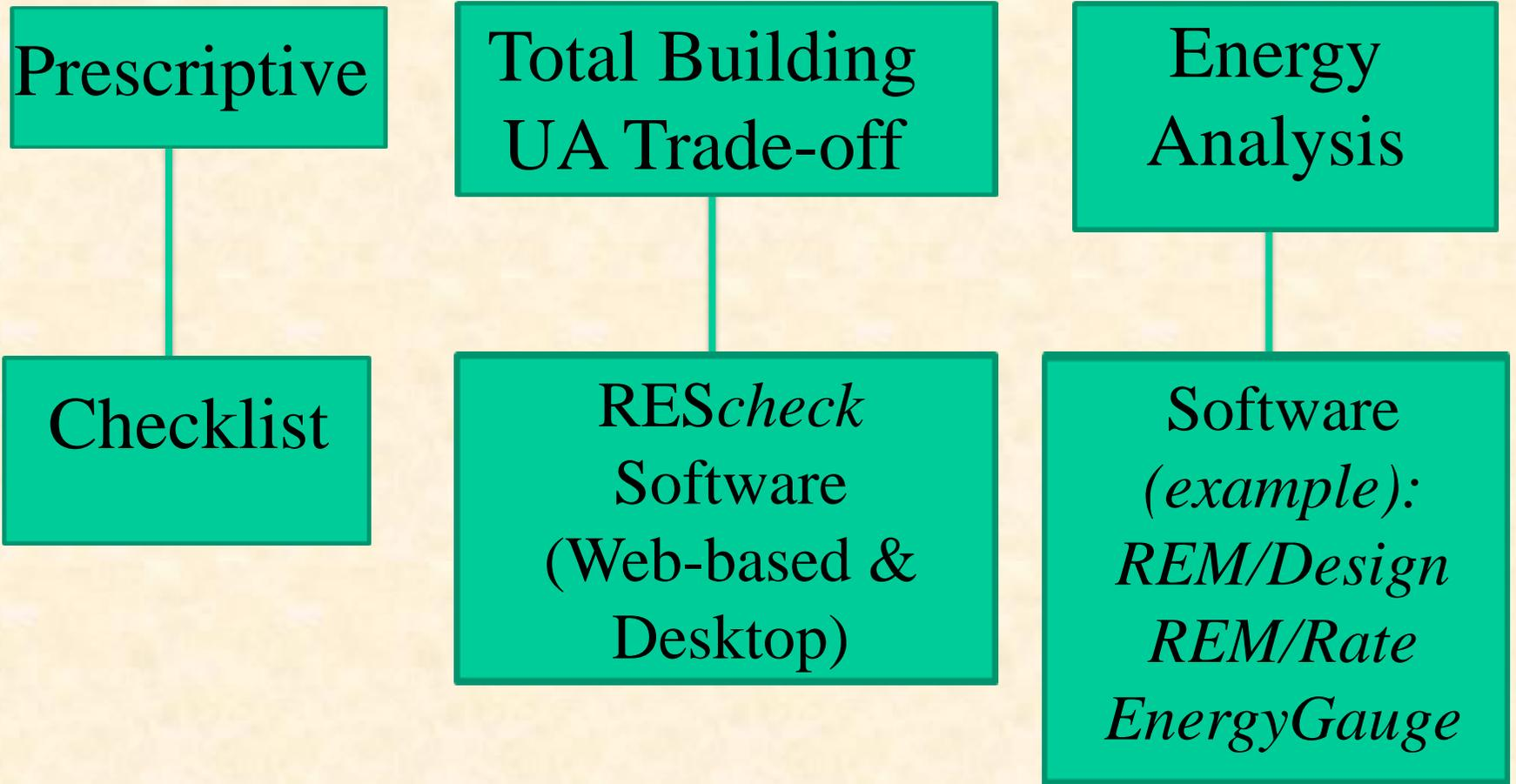

Building Envelope Specific Requirements

- Building Envelope consists of:
 - Ceilings
 - Walls
 - Above grade
 - Below grade
 - Mass walls
 - Fenestration
 - Floors
 - Slab
 - Crawl space

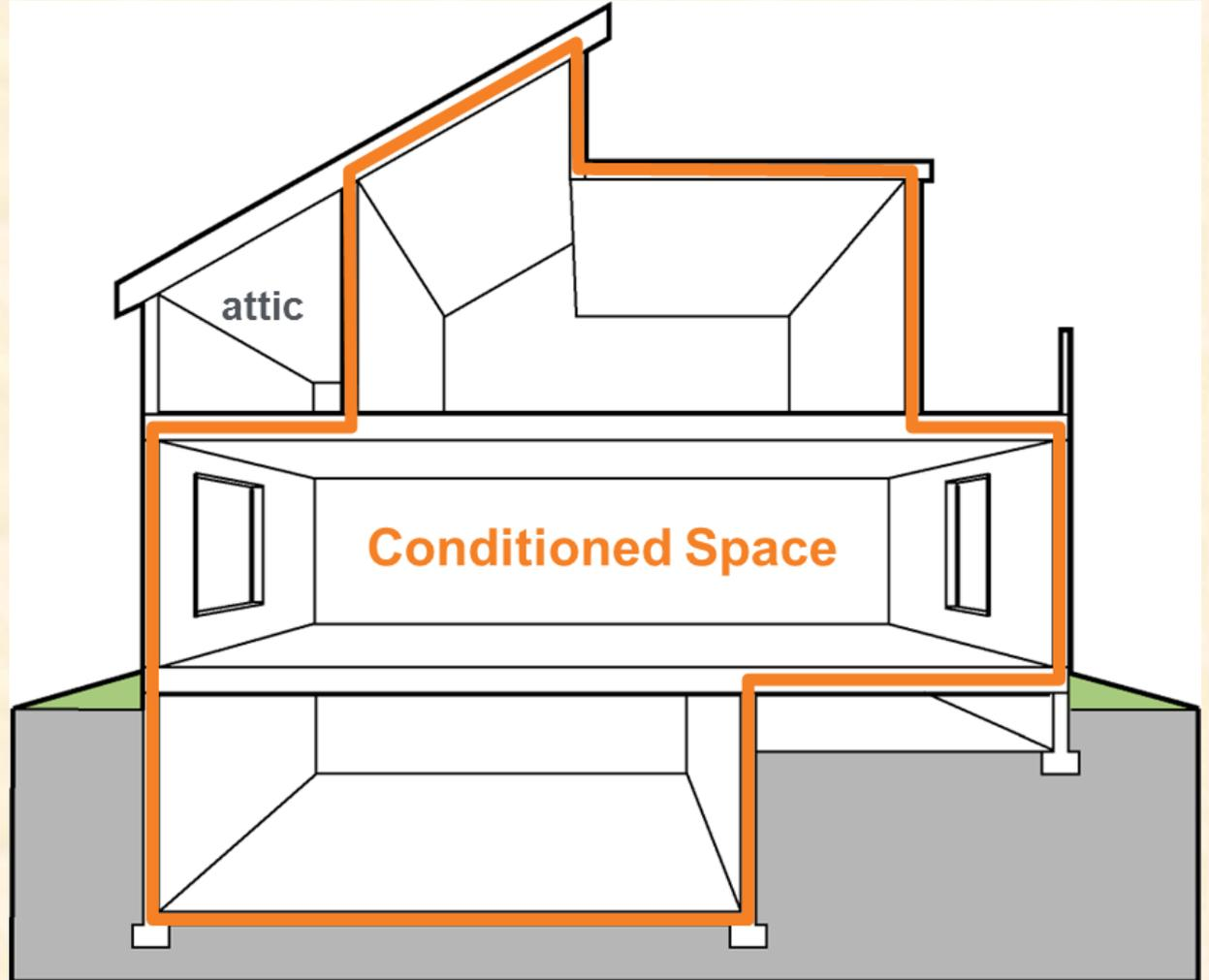

Ceilings N1102.2.1

- Requirements based on
 - Assembly type
 - Continuous insulation
 - Insulation between framing (cavity insulation)
- Meet or exceed R-values

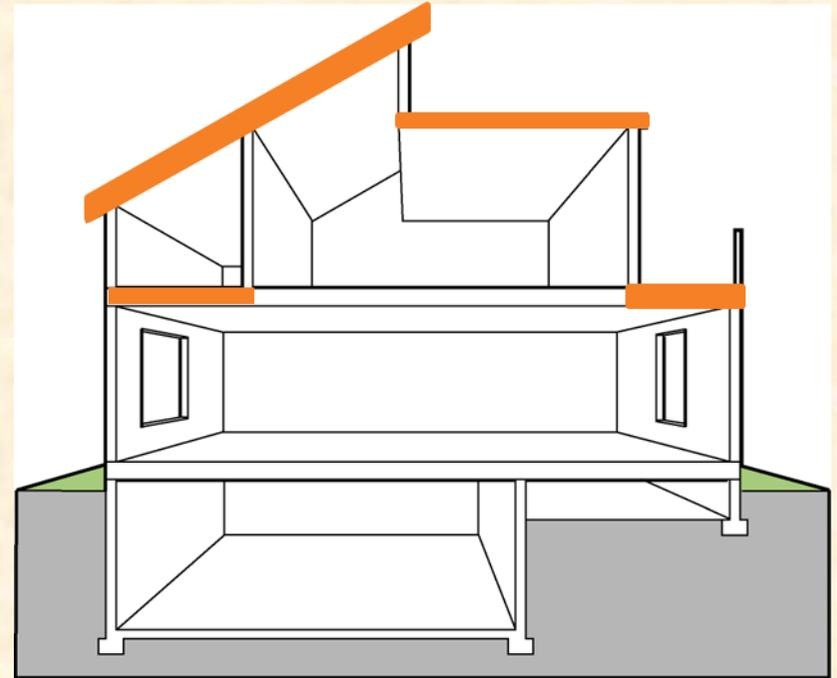

Ceilings

- Blown-in certificate at or near the opening of the attic.
The certificate should include:
 - R-value of installed thickness
 - initial installed thickness
 - installed density
 - settled thickness/settled R-value
 - coverage area
 - number of bags installed
- Markers every 300 square feet
- Uniformly throughout and extends over top of the exterior wall.

Ceilings with Attics N1102.2.1

- R-49
- Ceiling insulation requirements in R-value table assume standard truss systems

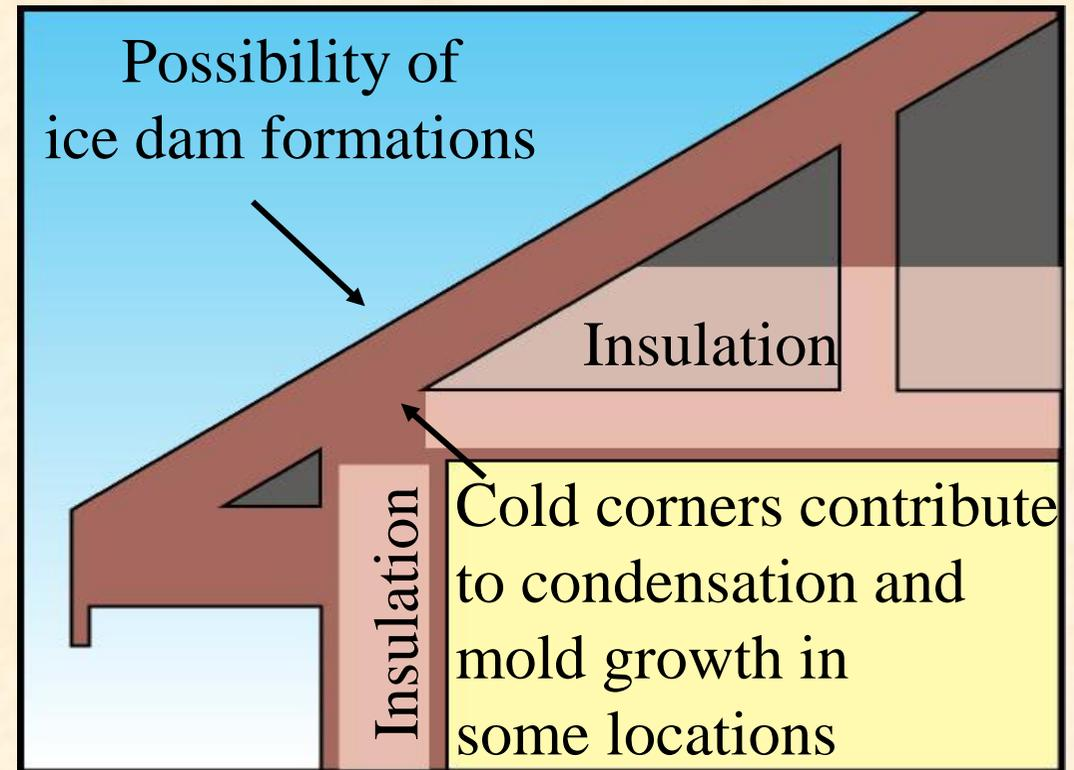

Ceilings with Attics, Cont'd.

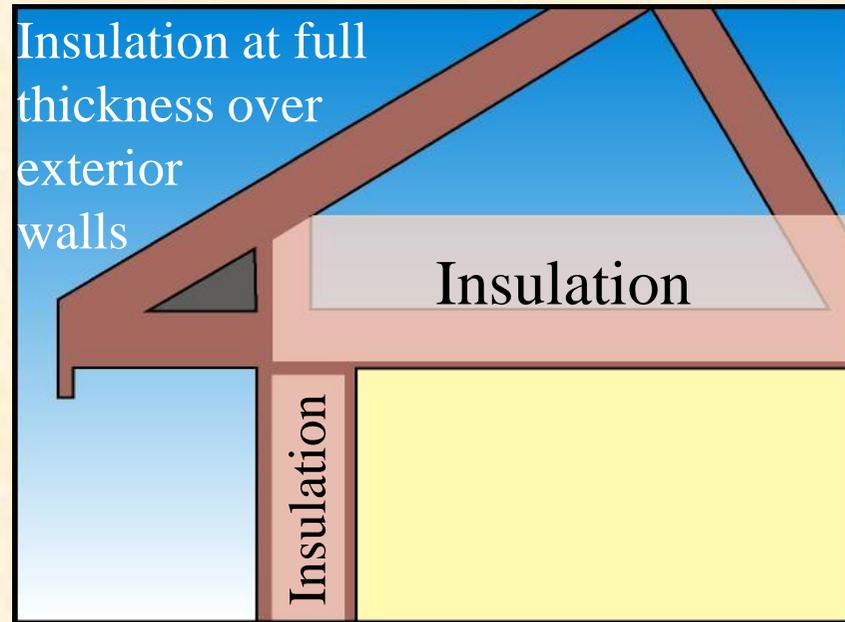

Prescriptive R-value path encourages raised heel truss (aka, energy truss)

- If insulation is full height over exterior wall top plate
 - R-38 complies where R-49 is required

Note: This allowance ONLY applies to the R-value prescriptive path, not the U-factor or Total UA alternatives

Ceilings without Attics (e.g., vaulted)

N1102.2.2

- Not sufficient amount of space to meet higher levels
- R-30 allowed for 500 ft² or 20% total insulated ceiling area, whichever is less

Access Hatches and Doors (Prescriptive) N1102.2.3

- Weatherstrip and insulate
- Insulate to level equivalent to surrounding surfaces
 - e.g., required ceiling insulation = R-49, then attic hatch must be insulated to R-49
- Install retainer when loose fill insulation is installed

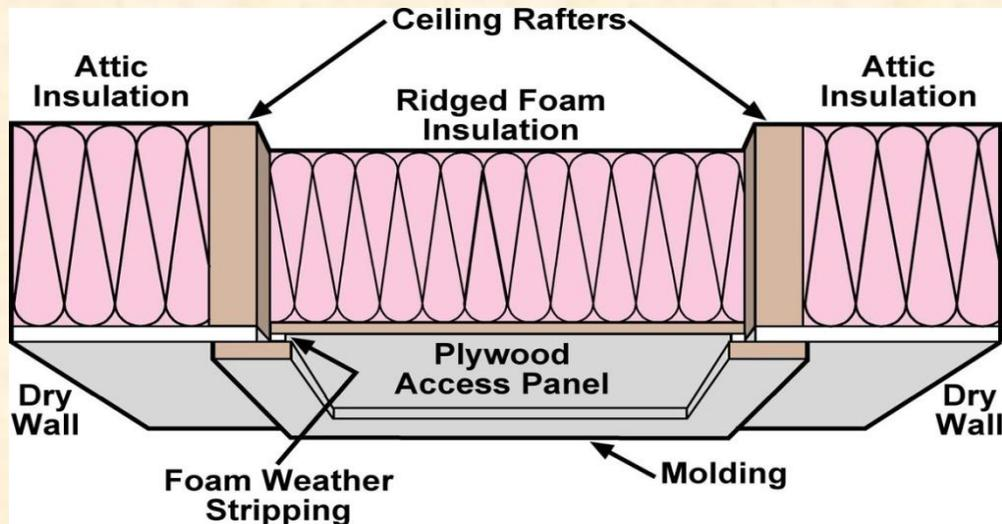

Walls Covered

- Exterior above-grade walls
- Attic kneewalls
- Skylight shaft walls
- Perimeter joists
- Basement walls
- Garage walls (shared with conditioned space)

Above Grade Walls

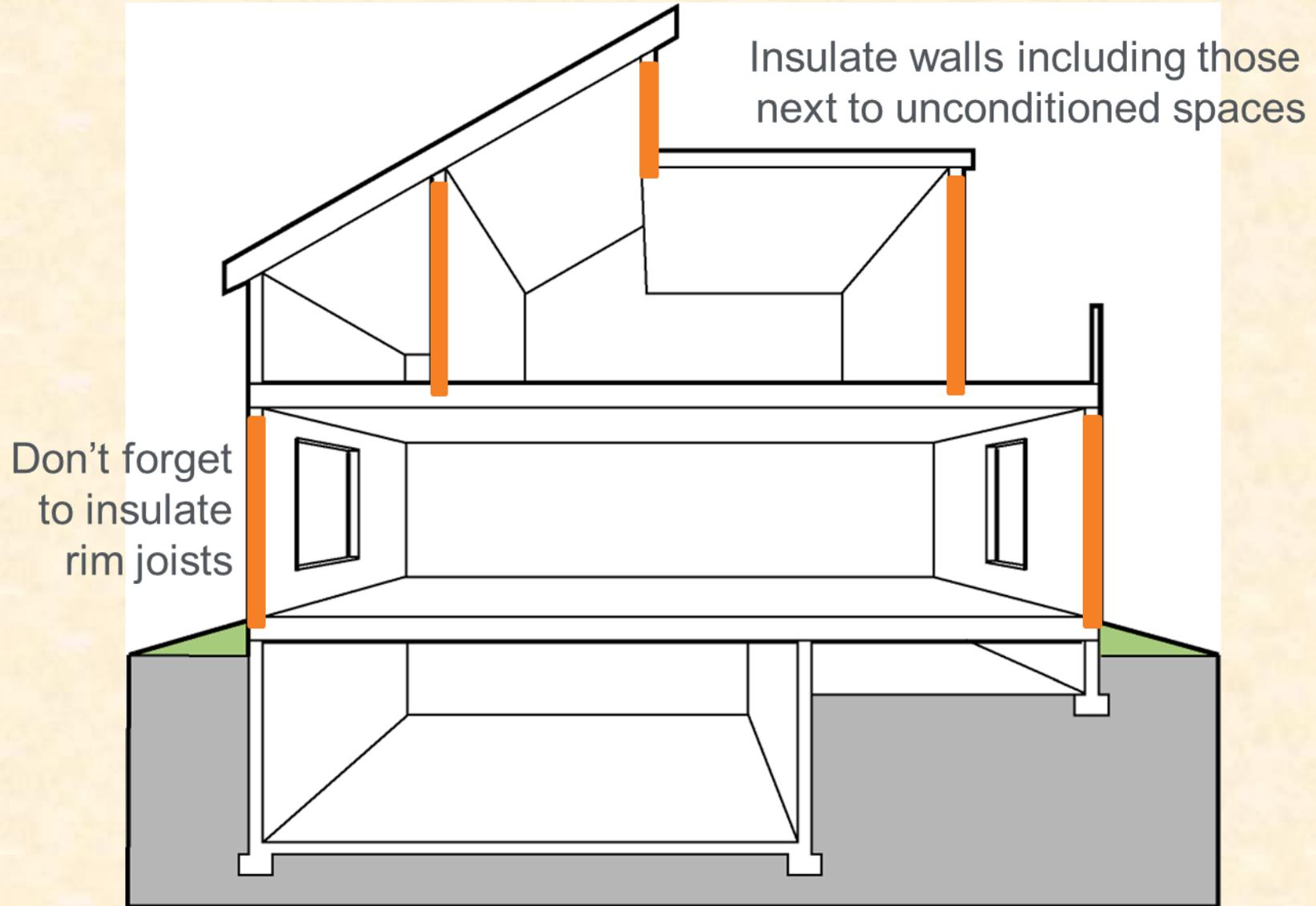

Wood-Frame Walls

**TABLE 402.1.1
INSULATION AND FENESTRATION REQUIREMENTS BY CLIMATE ZONE**

CLIMATE ZONE	FENESTRATION U-FACTOR ^b	SKYLIGHT ^b U-FACTOR	GLAZED FENESTRATION SHGC ^{b, e}	CEILING R-VALUE	WOOD FRAME WALL R-VALUE	MASS WALL R-VALUE ⁱ
1, 2, 3, 4, 5, 6, 7, 8	0.35	0.60	NR	38	13	3/4
					13	4/6
					13	5/8
					13	5/10
5 and Marine 4	0.35	0.60	NR	38	20 or 13+5 ^h	13/17
6	0.35	0.60	NR	49	19	15/19
7 and 8	0.35	0.60	NR	49	19	19/21

Required R-value can be met with any combination of cavity or continuous insulation

Exception in zones 5-6: R-13 cavity plus R-5 sheathing meets R-20 requirement

Mass Wall Requirements N1102.2.4

TABLE 402.1.1
INSULATION AND FENESTRATION REQUIREMENTS BY CLIMATE ZONE

CLIMATE ZONE	FENESTRATION U-FACTOR ^b	SKYLIGHT ^b U-FACTOR	GLAZED FENESTRATION SHGC ^{b, e}	CEILING R-VALUE	WOOD FRAME WALL R-VALUE	MASS WALL R-VALUE ⁱ
1	1.2	0.75	0.30	30	13	3/4
2					3	4/6
3					3	5/8
4 except Marine					3	5/10
5 and Marine 4					13+5 ^h	13/17
6					13+5 ^h	15/19
7 and 8	0.35	0.60	NR	49	21	19/21

Second (higher) number applies when more than half the R-value is on the interior of the mass (i.e., when the thermal mass is insulated from the conditioned space)

Outside/inside

Mass Walls

- What type
 - Concrete block, concrete, insulated concrete form (ICF), masonry cavity, brick (other than brick veneer), earth, and solid timber/logs

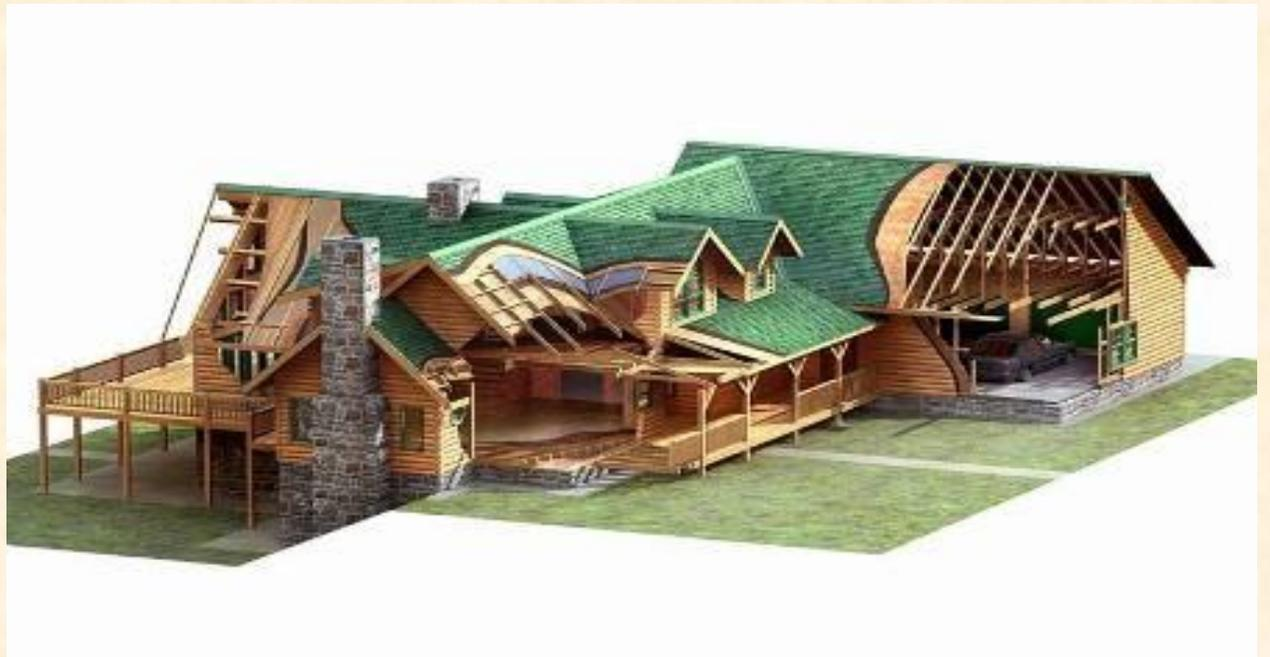

Steel-frame

N1102.2.5

Table N1102.2.5(IRC) 402.2.5(IECC)
Steel-Frame Ceiling, Wall and Floor Insulation(R-Value)

- Ceilings, walls, and floors

Wood Frame R-value	Cold-Formed Steel Equivalent R-value
Steel Truss Ceilings	
R-30	R-38 or R-30 + 3 or R-26 + 5
R-38	R-49 or R-38 + 3
R-49	R-38 + 5
Steel Joist Ceilings	
R-30	R-38 in 2x4, or 2x6, or 2x8 R-49 any framing
R-38	R-49 2x4, or 2x6, or 2x8, or 2x10
Steel Framed Wall	
R-13	R-13 + 5 or R-15 +4, or R-21 +3 or R-0+10
R-19	R-13 + 9 or R-19 +8 or R-25 +7
R-21	R-13 +10 or R-19 +9 or R-25 +8
Steel Joist Floor	
R-13	R-19, 2x6 R-19 + 6 in 2x8 or 2x10
R-19	R-19 + 6 in 2x6 R-19 +12 in 2x8 or 2x10

Steel Frame Walls (and ceilings, floors)

Table N1102.1(IRC) 402.2.5 (IECC)

Steel-Frame Ceiling, Wall and Floor Insulation (R-Value)

Wood Frame R-value	Cold-Formed Steel Equivalent R-value ^a
Steel Truss Ceilings ^b	
R-30	R-38 or R-30 + 3 or R-26 + 5
R-38	R-49 or R-38 + 3
R-49	R-38 + 5
Steel Joist Ceilings ^b	
R-30	R-38 in 2x4, or 2x6, or 2x8 R-49 any framing
R-38	R-49 2x4, or 2x6, or 2x8, or 2x10
	or R-0+10
R-13	R-19, 2x6 R-19 + 6 in 2x8 or 2x10
R-19	R-19 + 6 in 2x6 R-19 + 12 in 2x8 or 2x10

Table keys on the wood-frame requirement for the corresponding building component

- In ceilings, insulation that exceeds the height of the framing must cover the framing

Floors Over Unconditioned Space

N1102.2.6

TABLE 402.1.1
INSULATION AND FENESTRATION REQUIREMENTS BY COMPONENT

	FENESTRATION U-FACTOR ^b	SKYLIGHT ^b U-FACTOR	GLAZED FENESTRATION SHGC ^{b, e}	CEILING R-VALUE	WOOD FRAME WALL R-VALUE	MASS WALL R-VALUE ⁱ	FLOOR R-VALUE
	1.2	0.75	0.30	30	13	3/4	13
	0.65 ^j	0.75	0.30	30	13	4/6	13
	0.50 ^j	0.65	0.30	30	13	5/8	19
t	0.35	0.60	NR	38	13	5/10	19
4	0.35	0.	Exception: If framing members are too small to accommodate R-30, insulation that fills the framing cavity, not less than R-19, complies			/17	30 ^g
	0.35	0.				/19	30 ^g
	0.35	0.				/21	38 ^g

Floors over Unconditioned Space N1102.2.6

- Unconditioned space includes unheated basement, vented crawlspace, or outdoor air

Climate zone	IRC	IECC
6	30	30
7	30	38

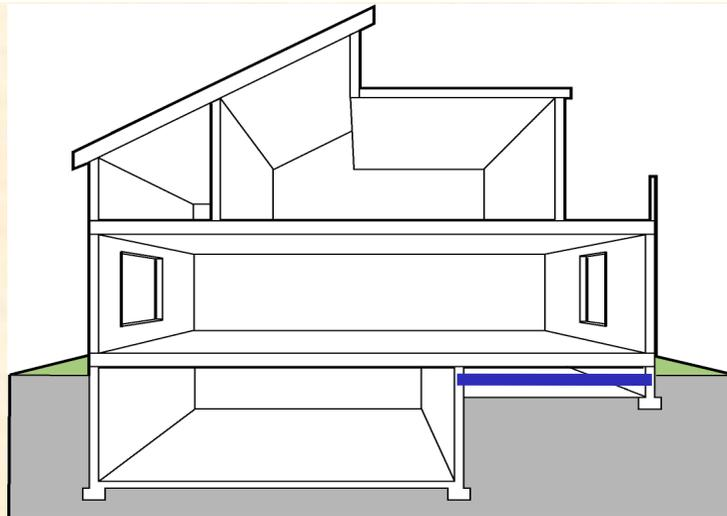

- Insulation must maintain permanent contact with underside of subfloor

* Exception:

Climate Zones 4c-8

R-19 permitted if cavity completely filled

Defining Below-Grade Walls N1102.2.7

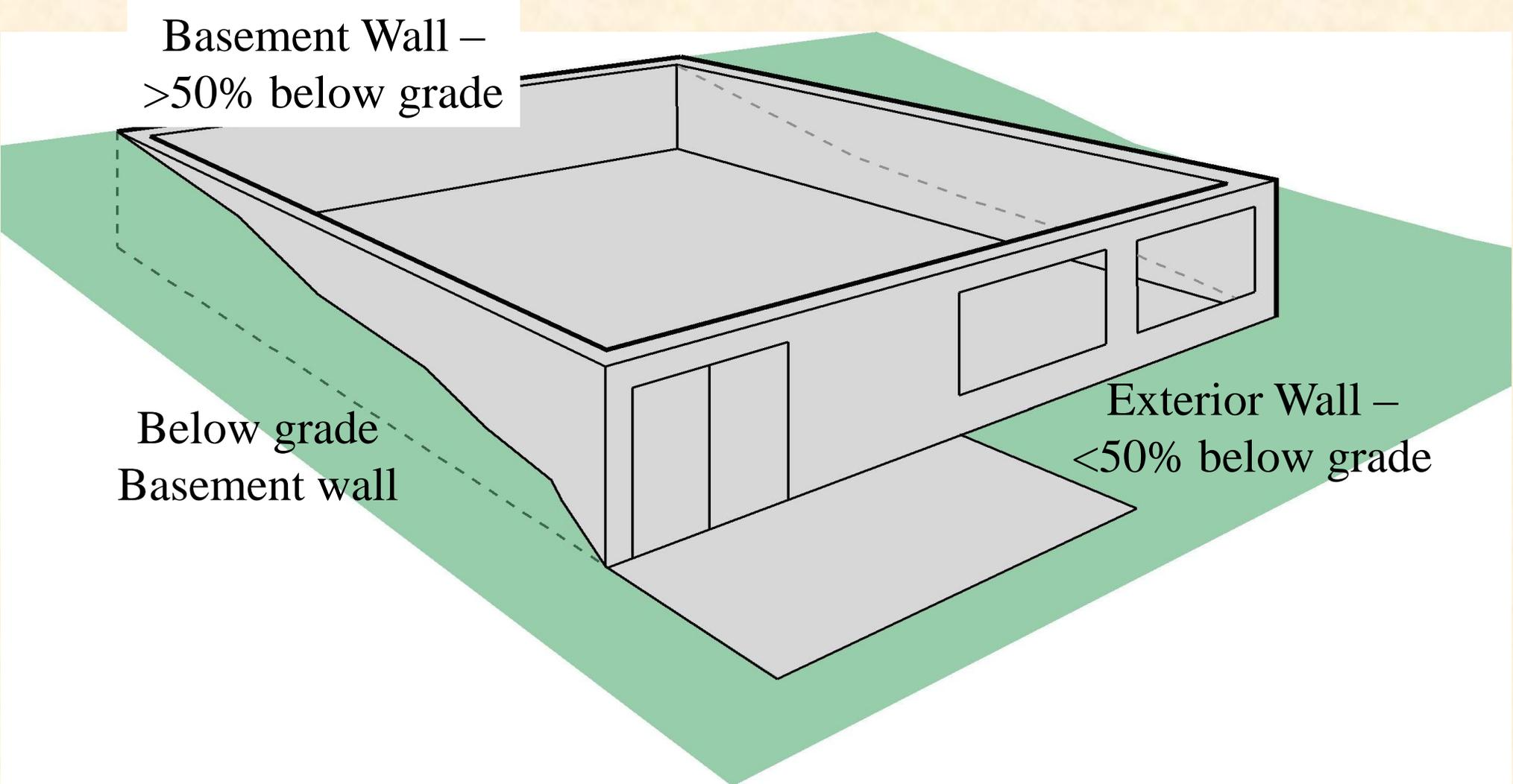

Below-Grade Walls

- $\geq 50\%$ below grade
- Otherwise treat as above- grade wall
- Insulated from top of basement wall down to 10 ft below grade or basement floor, whichever is less

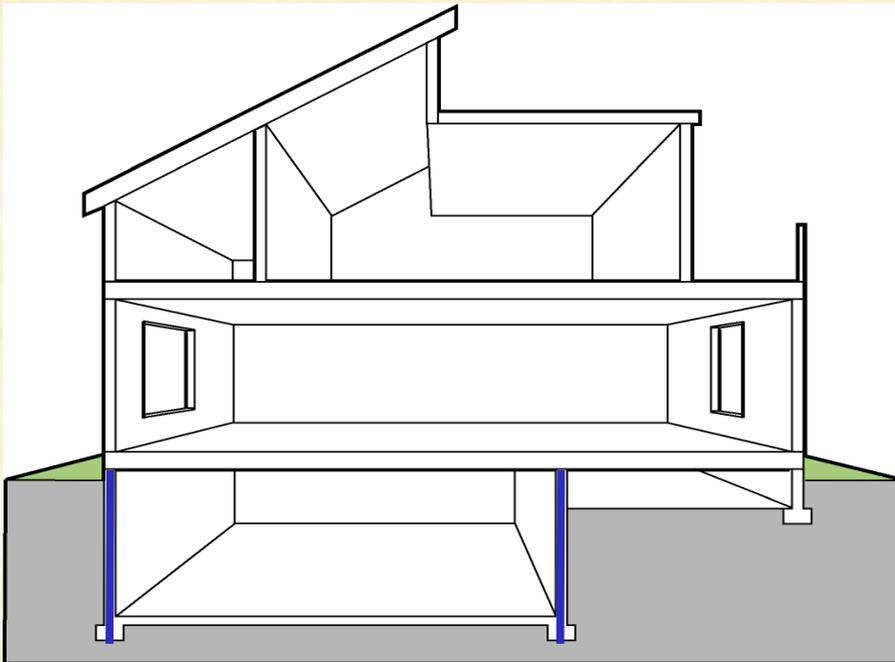

Foundation Insulation

Structure of house on foundation must be shifted outward to compensate for thickness of exterior insulation



Protection layer/system

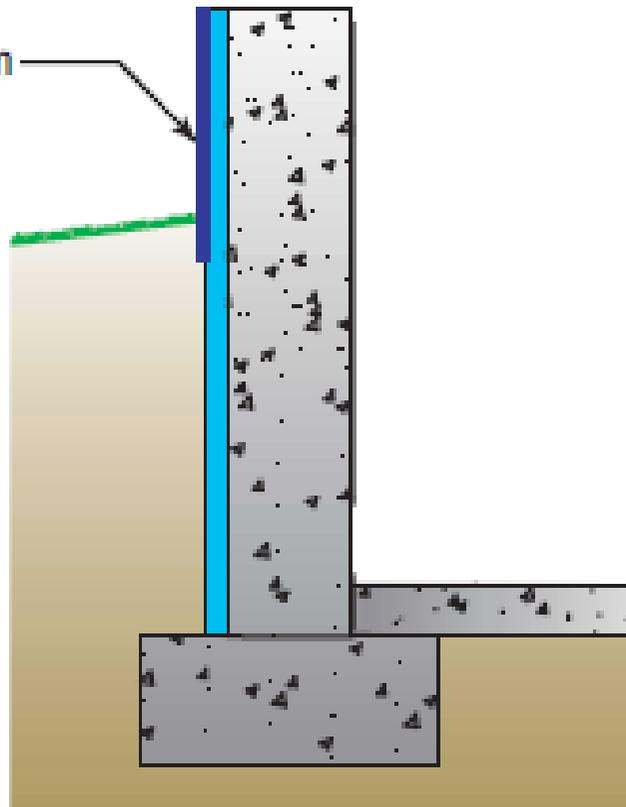

Foundation Insulation slides reprinted from *Basement Insulation Systems*. Authors: Nathan Yost and Joseph Lstiburek.

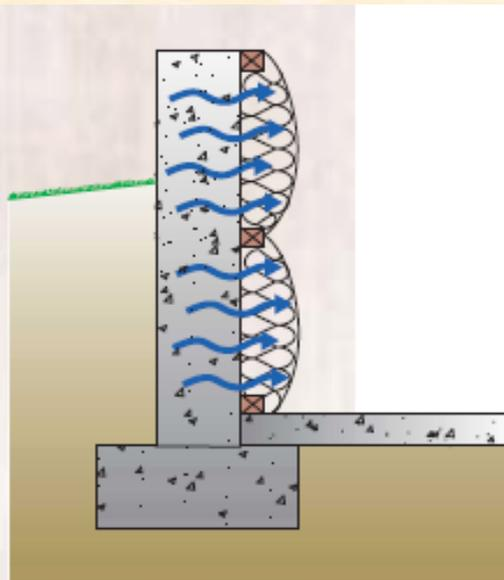

Figure 4

Moisture of construction

- Thousands of pounds of water are contained in freshly placed concrete in basement foundation walls; drying in uninsulated exposed walls takes many months, longer in walls with impermeable insulation systems

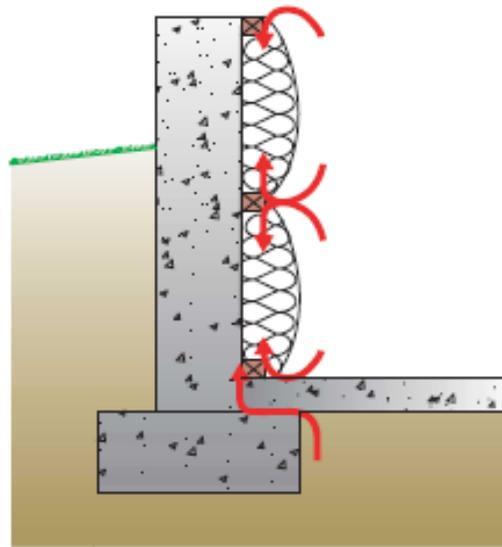

Figure 5

Air leakage from interior and from exterior under slab

- This is the "summer" problem where interior moisture laden air leaks into insulation systems and contacts cold concrete or masonry
- Can also be a winter problem, but is not usually common due to typically lower winter interior relative humidities - except in severe cold climates (greater than 8,000 heating degree days)

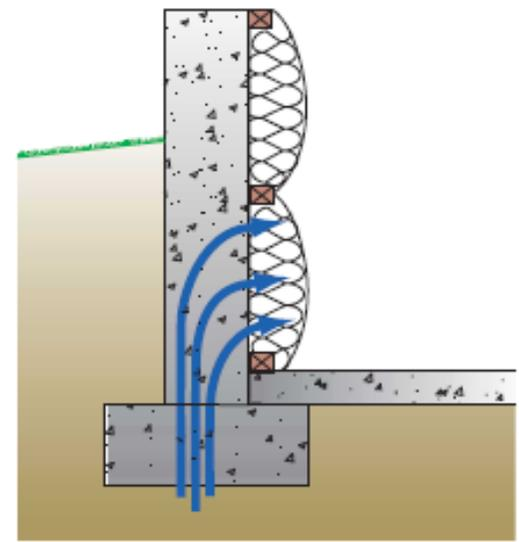

Figure 6

Capillary rise through footing

- This was rarely a problem until foundation walls became insulated on the interior with impermeable layers

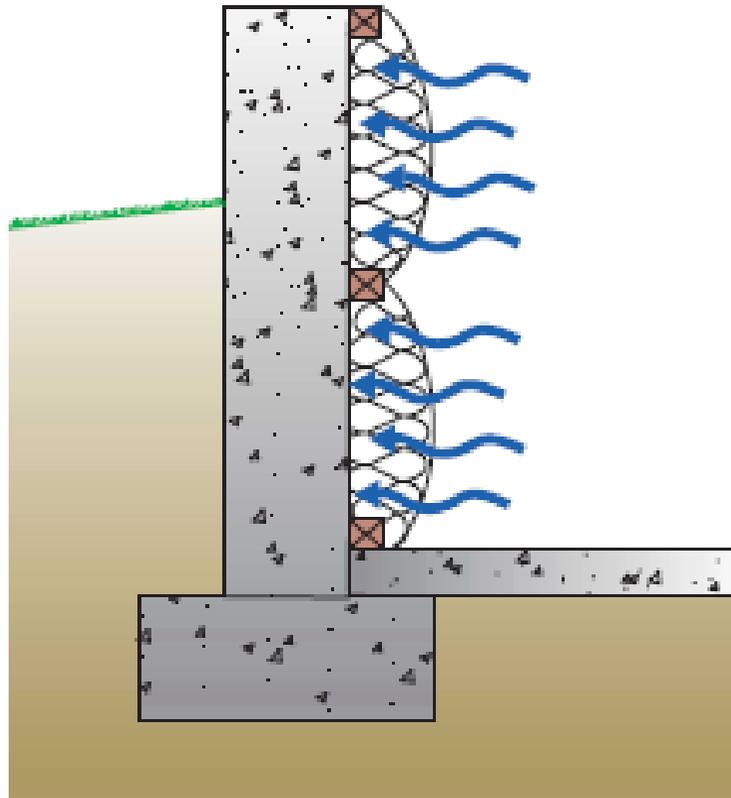

Figure 7

Diffusion from interior

- This is also a “summer” problem; occasionally a “winter” problem

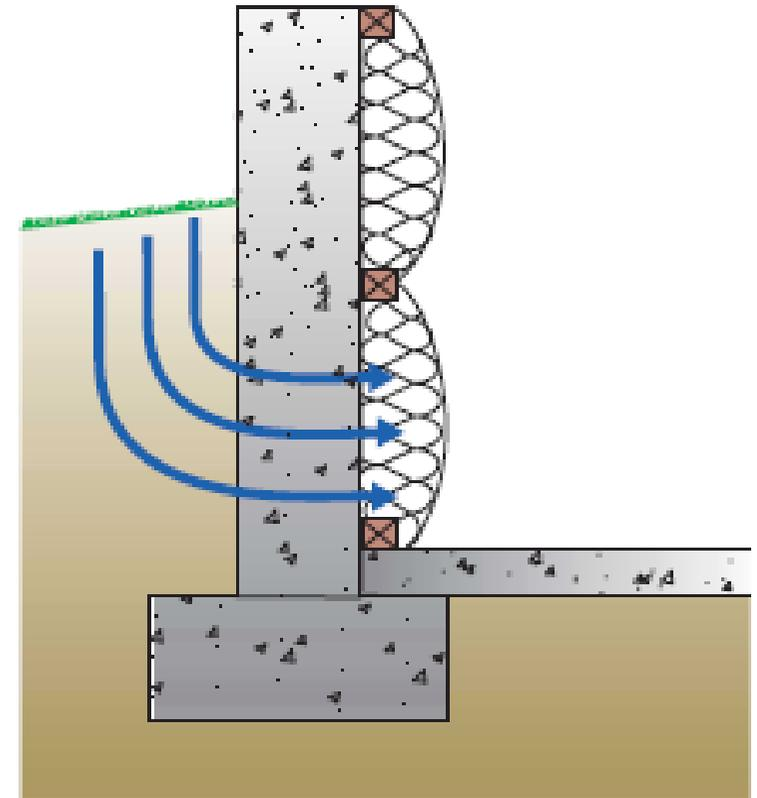

Figure 8

Groundwater leakage through foundation

- Major problem with water sensitive interior insulation and finishing systems

Foundation Insulation

- Interior Insulation
Recommendations
 - Must be able to dry to interior if it gets wet
 - Must prevent interior air from reaching foundation wall
 - Material in contact with foundation wall must be moisture tolerant.

Exterior Foundation Insulation

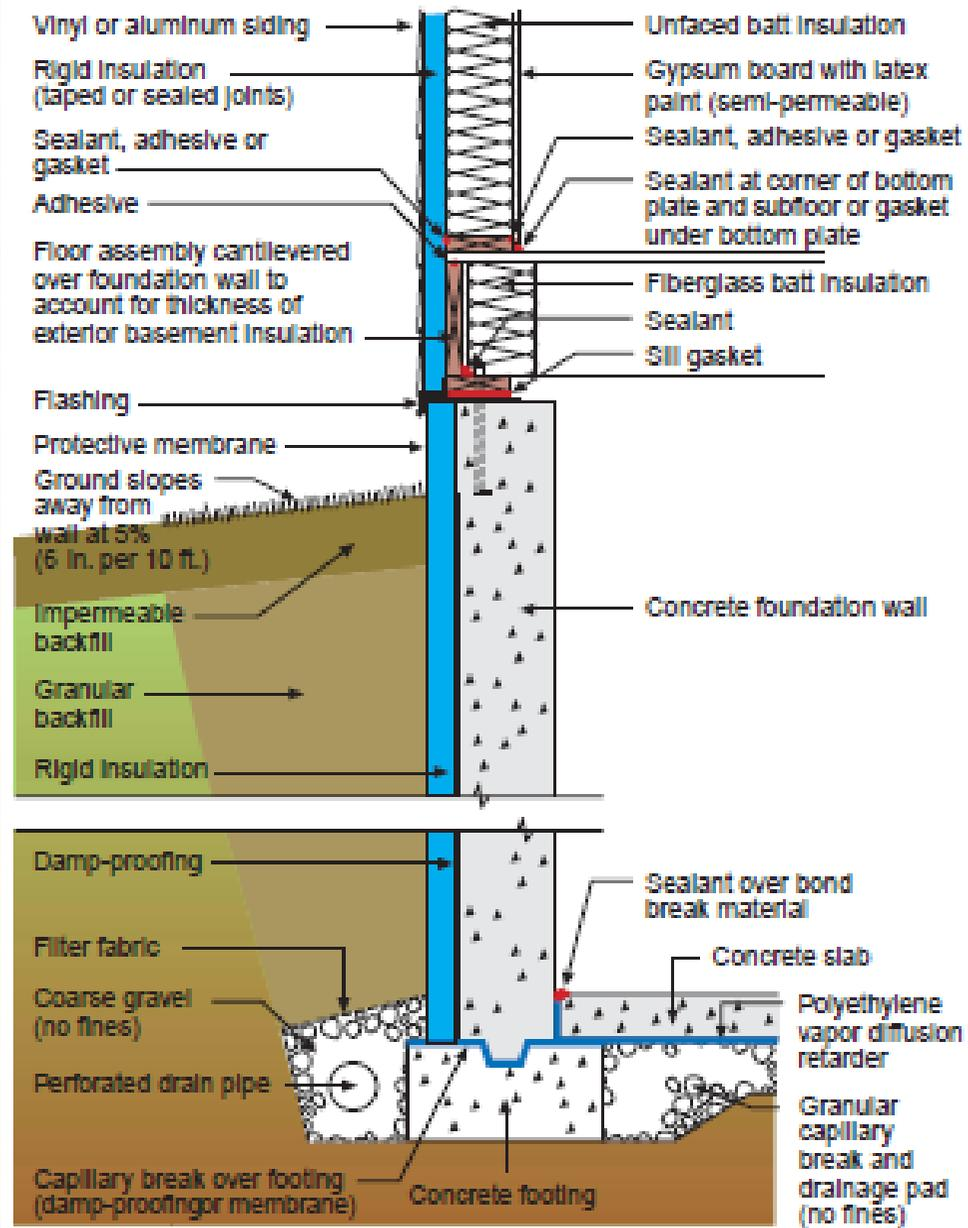

Interior Foundation Insulation- Rigid Insulation

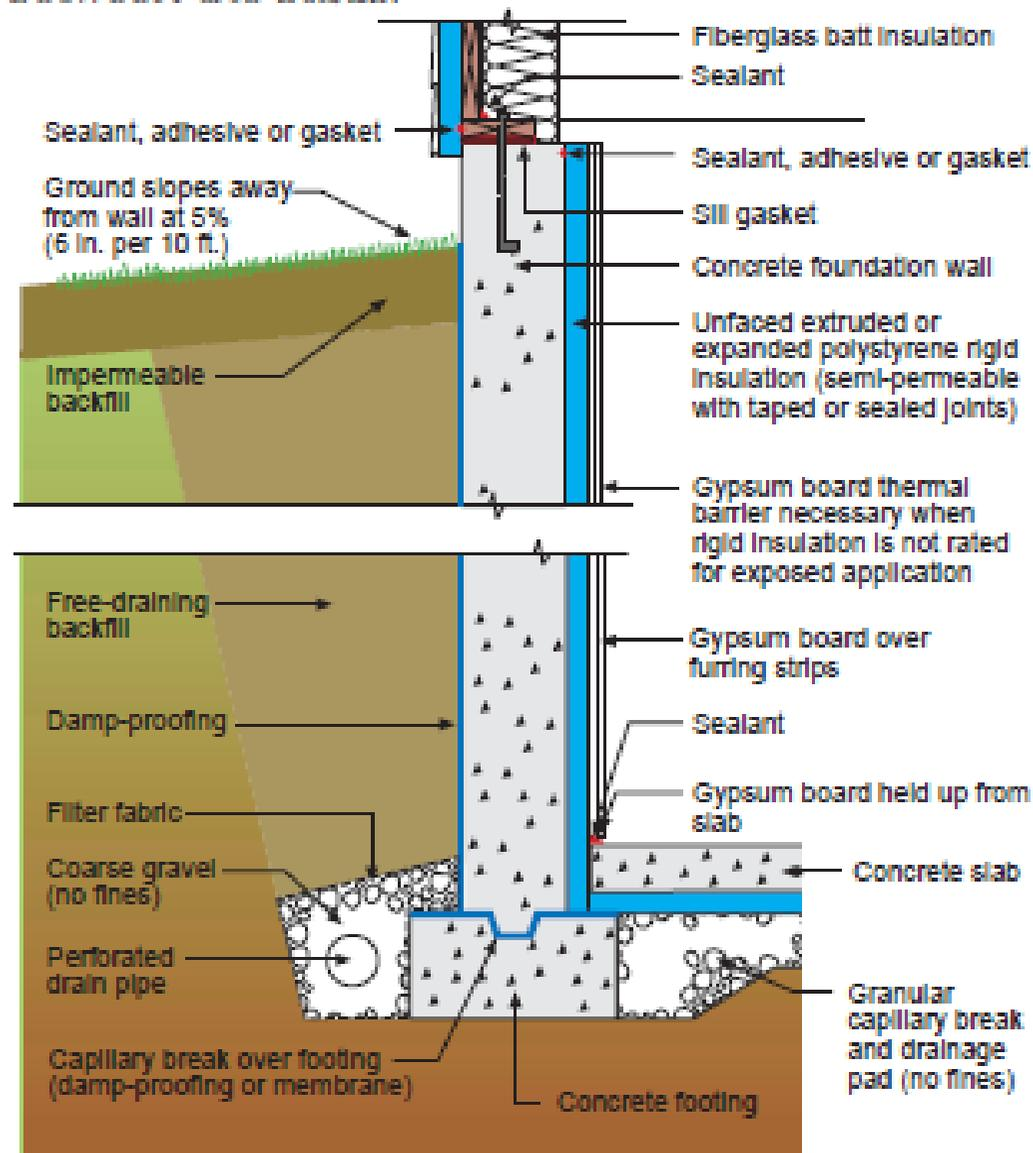

Figure 13
Full height basement insulation

- Upper and lower portion of wall can dry to interior

Interior Foundation Insulation – Rigid Insulation with fiberglass

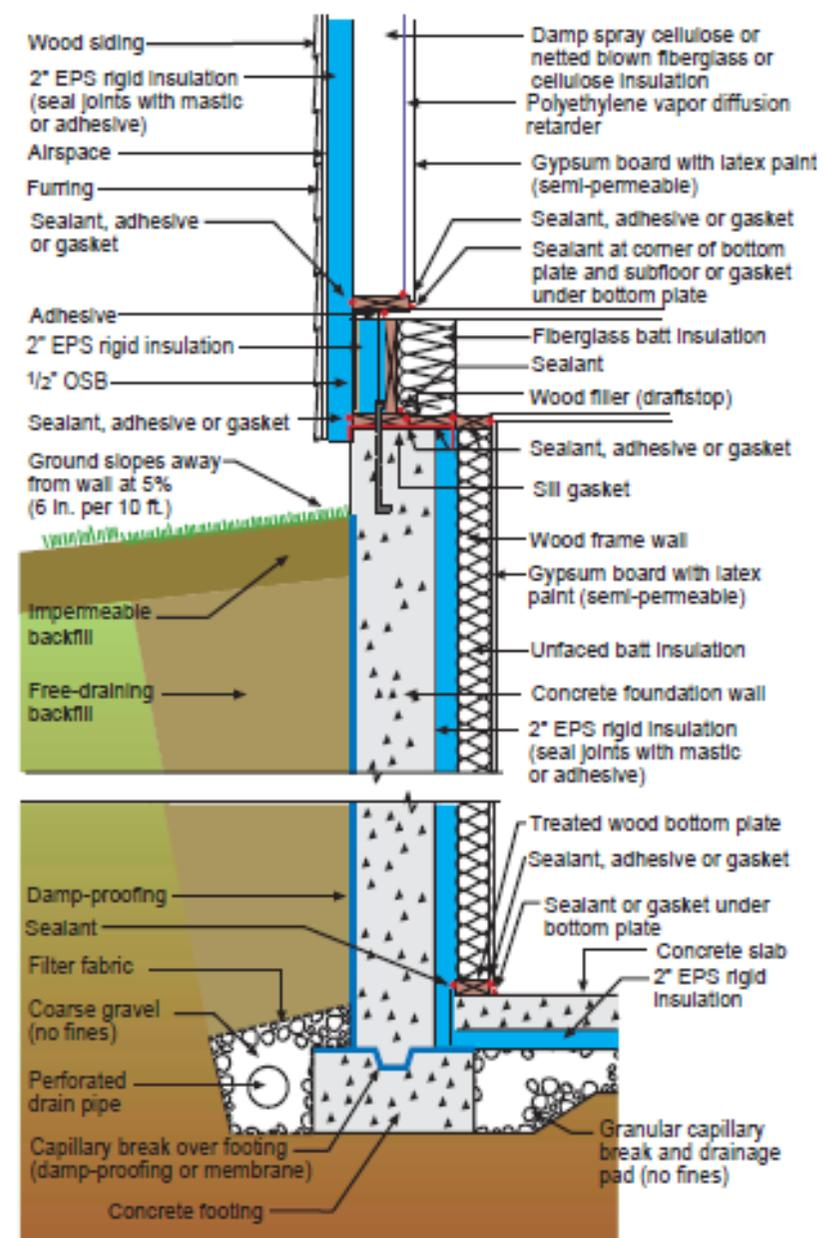
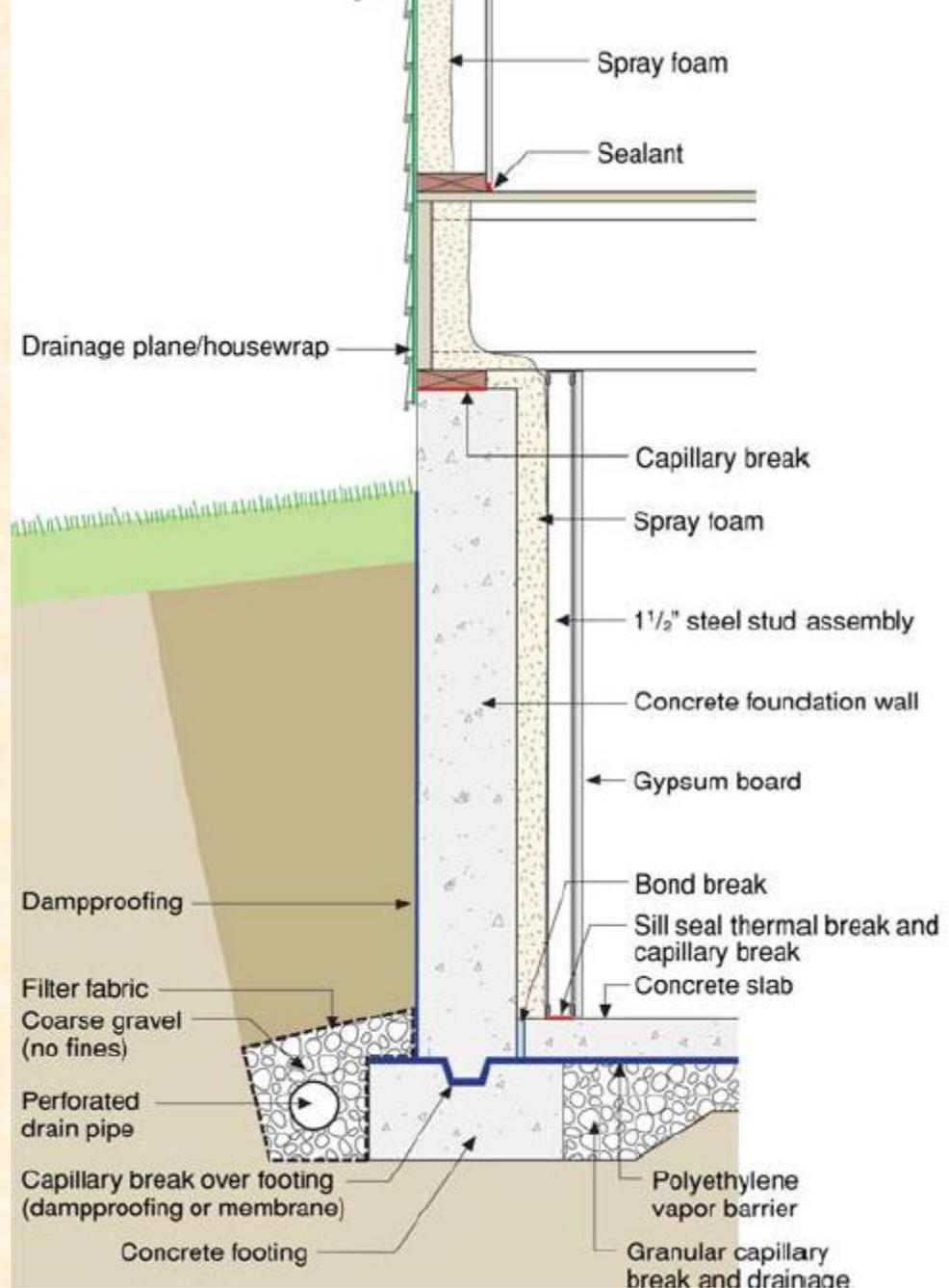

Figure 14
Additional interior basement insulation

Interior Foundation Insulation – Spray Foam



Slab Edge Insulation N1102.2.8

- Applies to slabs with a floor surface < 12 inches below grade
 - R-10 (typically 2 inches)
 - extend downward from top of slab a minimum 4 feet
 - Insulation can be vertical or extend horizontally under the slab or out from the building
 - Insulation extending outward must be under 10 inches of soil or pavement
- An additional R-5 is required for heated slabs

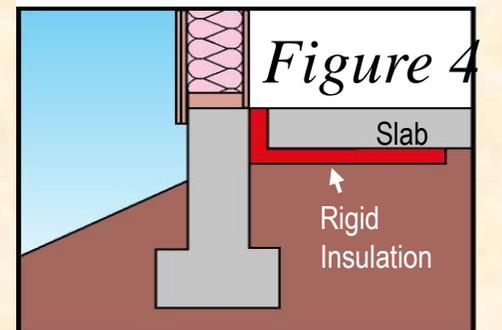
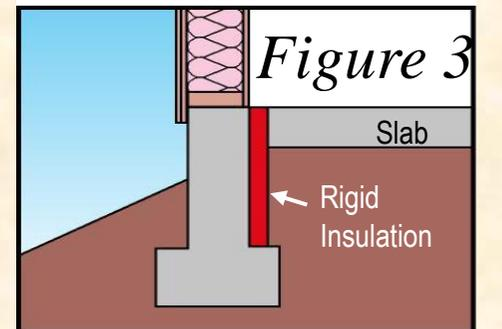
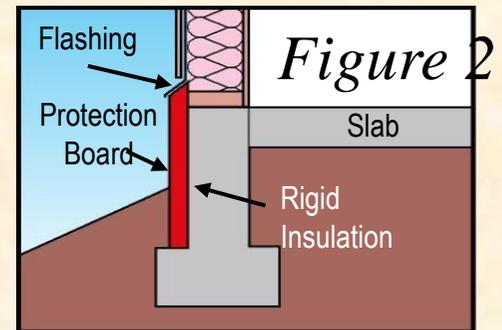

Slab Edge Insulation

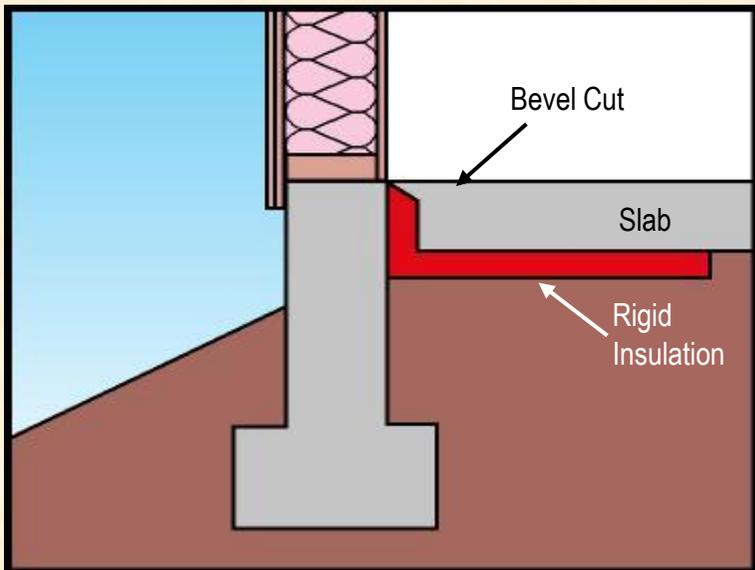

Crawlspace Wall Insulation N1102.2.9

- Implies an unvented crawlspaces (aka, conditioned crawlspace, mini basement)
 - Space must be mechanically vented or receive minimal supply air (see Section R408 of the IRC)
 - Exposed earth must be covered with a continuous Class I vapor retarder (Overlap 6” and taped)

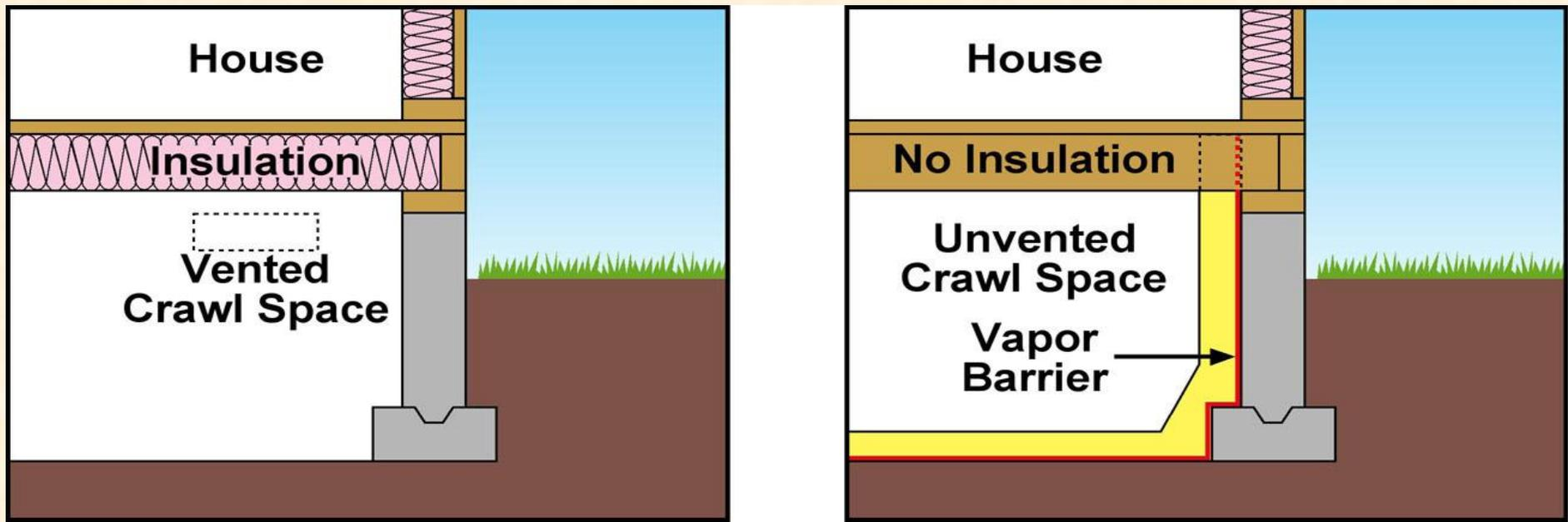

Fenestration N1102.3

- Doors and windows
 - NFRC rating or default table $U=.35$
 - If no labeled U-factor and SHGC, use default table
 - No glass area limits
 - Exemptions (prescriptive path only)
 - Up to 15 ft² of glazing per dwelling unit (Section N1102.3.3 or 402.3.3)
 - One side-hinged opaque door assembly up to 24 ft² (Section N 1102.3.4 or 402.3.4)

 National Fenestration Rating Council CERTIFIED	World's Best Window Co. Millennium 2000+ Vinyl-Clad Wood Frame Double Glazing • Argon Fill • Low E Product Type: Vertical Slider
ENERGY PERFORMANCE RATINGS	
U-Factor (U.S./I-P)	Solar Heat Gain Coefficient
0.35	0.32
ADDITIONAL PERFORMANCE RATINGS	
Visible Transmittance	Air Leakage (U.S./I-P)
0.51	0.2
Condensation Resistance	_____
51	
<small>Manufacturer certifies that these ratings conform to applicable NFRC procedures for determining whole product performance. NFRC ratings are determined for a fixed set of environmental conditions and a specific product size. Consult manufacturer's literature for other product performance information. www.nfrc.org</small>	

Simulated Performance Alternative IECC

- Requires computer software with specified capabilities (local official may approve other tools)
- Includes both envelope and some systems, but not HVAC or water heater efficiency
- Allows greatest flexibility
 - Can trade-off tight duct systems
- Defines compliance based on equivalency of calculated energy or energy cost
- Section 405 specifies “ground rules”
 - These will generally be “hidden” in compliance software calculation algorithms
 - Very similar ground rules are used in home federal tax credits and ENERGY STAR Home guidelines

Mandatory Requirements – Air Leakage

N1102.4

- Building thermal envelope (Section 1102.4 or 402.4)
- Recessed lighting
- Fenestration
- Fireplaces

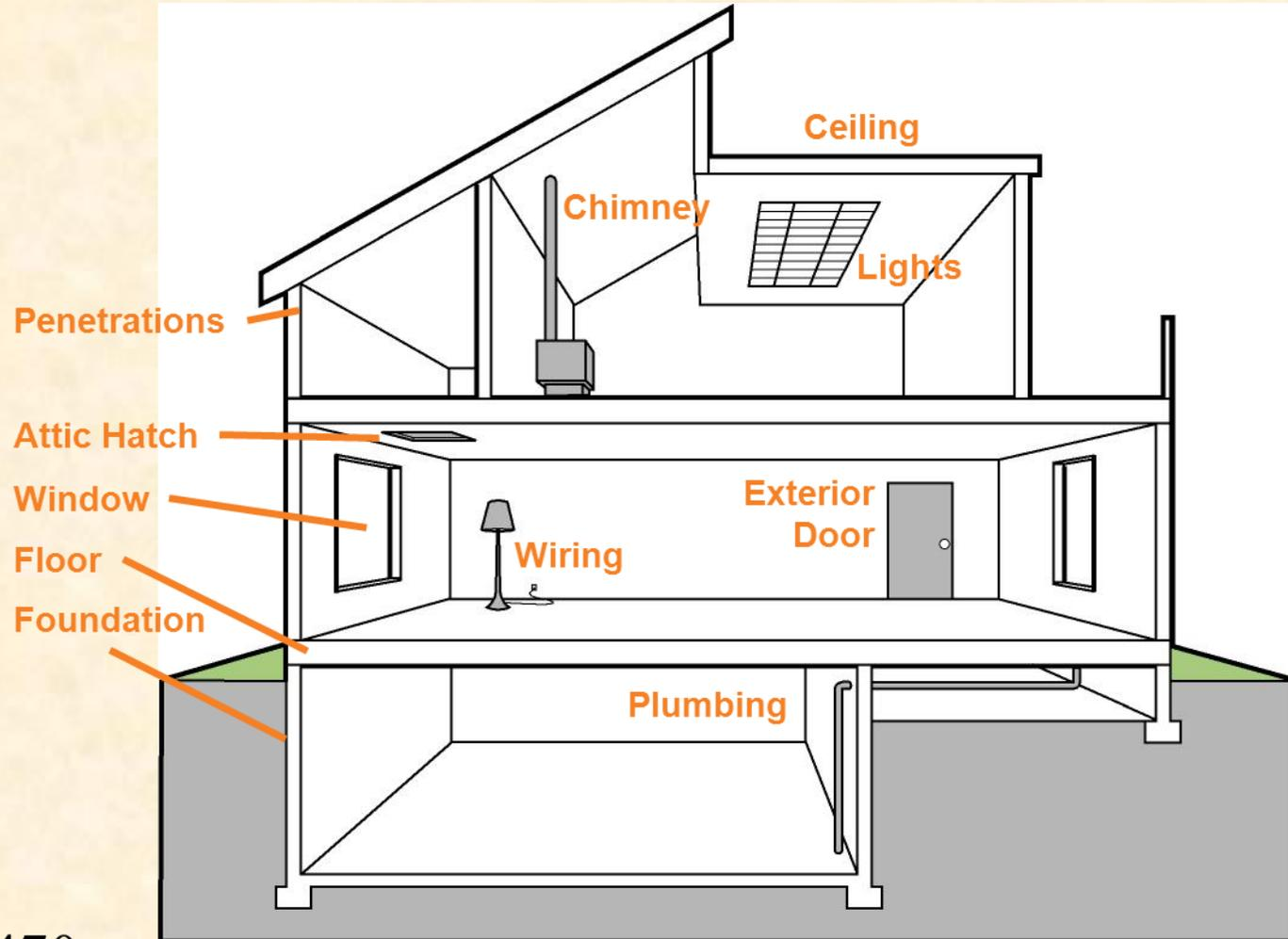

Air Sealing and Insulation N1102.4.2

- Two options to demonstrate compliance
 - Whole-house pressure test
 - Air leakage <7 ACH when tested at pressure differential of 0.2 inches w.c. Testing may occur any time after rough in and installation of building envelope penetrations
 - Field verification of items listed in Table N1102.4.2(IRC) 402.4.2 (IECC).



Air Leakage Control

- Building thermal envelope
 - Durably sealed
 - Caulked
 - Gasketed
 - Weatherstripped
 - Air barrier material
 - Suitable film or solid material



- Is this durably sealed?

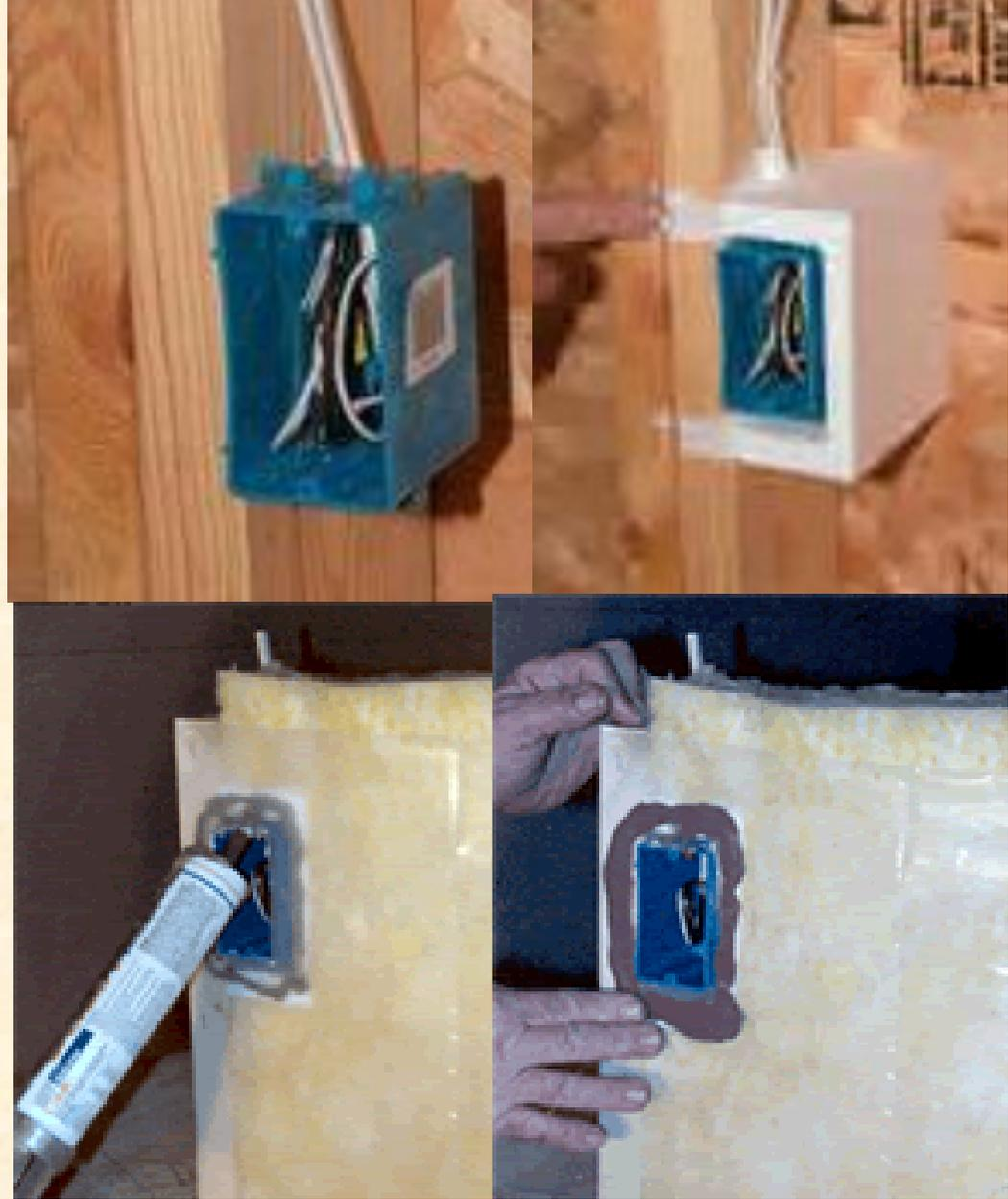

Image courtesy of Energy Block

Areas for Air Leakage (Infiltration)

- Windows and doors
- Sill plates
- Floors and exterior wall panels
- Plumbing
- Electrical
- Service access doors or hatches
- Recessed light fixtures
- Rim joist junction



Fireplaces N1102.4.3

- New wood-burning fireplaces shall have gasketed doors and outdoor combustion air.



Fenestration – Air Leakage

N1102.4.4

Windows, sliding glass doors and skylights

- Air filtration rate ≤ 0.3 cfm/ft²
- Swinging doors
 - ≤ 0.5 cfm/ft²
- Exceptions
 - Site-built windows, skylights, and doors

Recessed Lighting Fixtures

N1102.4.5

- Type IC rated and labeled as meeting ASTM E 283 when tested at 1.57 psf (75 Pa) pressure differential with no more than 2.0 cfm of air movement
- Sealed with a gasket or caulk between the housing and interior wall or ceiling covering



Mechanical Systems & Equipment

- Equipment efficiency set by Federal law, not the I-Codes



Mandatory Requirements Systems (Section IECC 403)

- Controls
- Heat pump supplementary heat
- Ducts
 - Sealing (Mandatory)
 - Insulation (Prescriptive)
- HVAC piping insulation
- Circulating hot water systems
- Ventilation
- Equipment sizing
- Systems serving multiple dwelling units
- Snow melt controls
- Pools

Programmable Thermostat – Controls

ONLY IECC COMPLIANCE

- If primary heating system is a forced-air furnace
 - At least one programmable thermostat/dwelling unit
 - Capability to set back or temporarily operate the system to maintain zone temperatures
 - down to 55°F (13°C) or
 - up to 85°F (29°C)
 - Initially programmed with:
 - heating temperature set point no higher than 70°F (21°C) and
 - cooling temperature set point no lower than 78°F (26°C)



Heat Pump Supplementary Heat - Controls

- Prevent supplementary electric-resistance heat when heat pump can meet the heating load
- Exception
 - During defrost

Ducts N1103.2

- Insulation (Prescriptive)
 - Supply ducts in attics: R-8
 - All other ducts: R-6
- Sealing (Mandatory)
 - Joints and seams shall comply with IRC, Section M1601.4.1
- Building framing cavities shall not be used as supply ducts



Duct Location Examples

Location	Requirement
Attic	R-8
Conditioned Space	-
Vented Crawl Space	R-6
Conditioned Crawl Space	-
Basement – Conditioned	-
Basement – Unconditioned	R-6
Exterior Walls	R-6

Duct Tightness Tests

- All ducts, air handlers, filter boxes and building cavities used as ducts shall be sealed (Section 403.2.2)
- Duct tightness shall be verified *by either* –
 - Post construction test
 - Leakage to outdoors: ≤ 8 cfm/per 100 ft² of conditioned floor area
 - or**
 - Total leakage: ≤ 12 cfm/per 100 ft² of conditioned floor area
 - tested at a pressure differential of 0.1 in w.g. (25Pa) across entire system, including manufacturer's air handler enclosure
 - All register boots taped or otherwise sealed
 - OR
 - Rough-in test
 - Total leakage ≤ 6 cfm/per 100 ft² of conditioned floor area
 - tested at a pressure differential of 0.1 in w.g. (25Pa) across roughed-in system, including manufacturer's air handler enclosure
 - all register boots taped or otherwise sealed
 - if air handler not installed at time of test
 - » Total air leakage ≤ 4 cfm/per 100 ft²

Exceptions: Duct tightness test is not required if the air handler and all ducts are located within conditioned space!!!!!!!!!!!!!!!!!!!!!!

Piping Insulation

- R-3 required on (N1103.3)
 - HVAC systems
 - Exception: Piping that conveys fluids between 55 and 105°F
- R-2 required on (N1103.4)
 - All circulating domestic hot water systems
 - Systems also require a readily accessible manual switch



Ventilation and Equipment Sizing

- Ventilation (N1103.5)
 - Outdoor air intakes and exhausts shall have automatic or gravity dampers that close when the ventilation system is not operating
- Equipment Sizing (N1103.6)
 - Section M1401.3 of the IRC
 - Load calculations determine the proper capacity (size) of equipment
 - Goal is big enough to ensure comfort but no bigger
 - Calculations shall be performed in accordance with ACCA Manual J or other approved methods

Snow Melt System Controls N1103.7

- Snow- and ice-melting system controls
 - Automatic shutoff when pavement temperature is $> 50^{\circ}\text{F}$ and no precipitation is falling
 - Automatic or manual shutoff when outdoor temperature is $> 40^{\circ}\text{F}$

Pools N1103.8

- Pool heaters
 - with a readily accessible on-off switch
 - fired by natural gas not allowed to have continuously burning pilot lights
- Time switches to automatically turn off and on heaters and pumps according to a preset schedule installed on swimming pool heaters and pumps.
 - Exceptions
 - Public health standards requiring 24-hour pump operation
 - Pumps operating pools with solar-waste-heat recovery heating systems



Pool Covers

- On heated pools
 - If heated to >90 F, vapor-retardant pool cover at least R-12
 - Exception: If $>60\%$ of energy from site-recovered or solar energy source

Systems (IECC)

- Systems serving multiple dwelling units shall comply with Sections 503 and 504 in lieu of Section 403

Lighting Equipment IECC (Prescriptive) N1104.1

- A minimum of 50 percent of the lamps in permanently installed lighting fixtures shall be high-efficacy lamps. (**Amended out of IRC**)



Compliance/Documentation/ Inspections

- Code Official has final authority
 - Software, worksheets
 - Above Code Programs
- Electronic media can be used
- Construction work for which a permit is required is subject to inspection
- Certificate is required

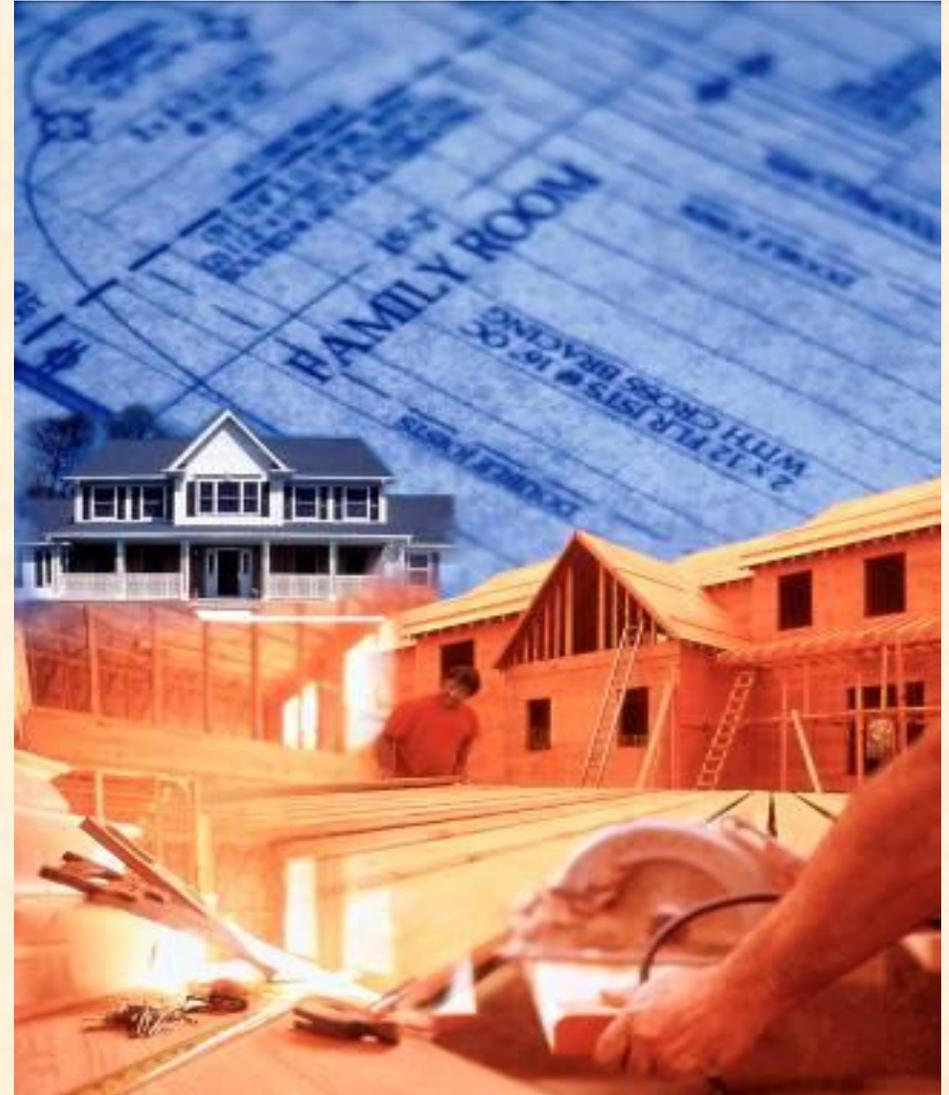

Compliance/Documentation/ Inspections

- Code Officials Inspection
 - Successive and final inspections, and reinspections if necessary
- Code Validity
 - Code deemed to be illegal or void shall not affect the remainder of the code
- Codes and standards considered part of the requirements of the code
 - Provisions take precedence
- Fees
 - Must be paid before permit is issued
 - Required in accordance with schedule

Additions

- Treat as a stand-alone building
- Additions must meet the prescriptive requirements in Table 1102.1 or 402.1.1 (or U-factor or total UA alternatives)

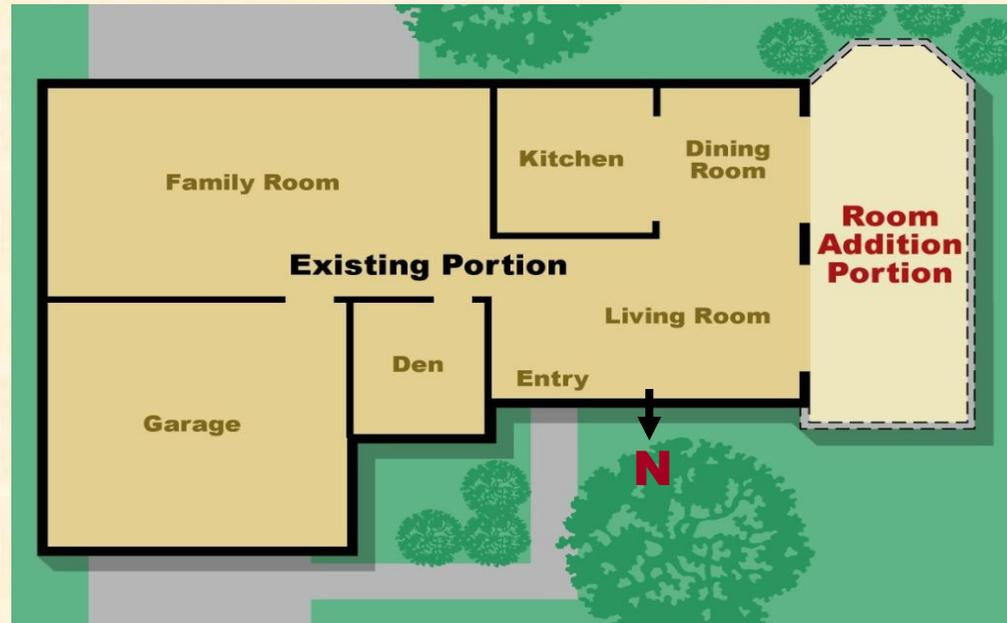

Sunrooms -IECC

Less stringent insulation

R-value and glazing

U-factor requirements

Sunroom definition:

- One story structure
- Glazing area $>40\%$ glazing of gross exterior wall and roof area
- Separate heating or cooling system or zone
- Must be thermally isolated (closeable doors or windows to the rest of the house)
- Can always meet Table 402.1.1 requirements with unlimited glass



Sunroom Requirements - IECC

- Ceiling Insulation
 - Zones 5-8 R-24
- Wall Insulation
 - All zones R-13
- Fenestration U-Factor
 - Zones 4-8 0.50
- Skylight U-Factor
 - Zones 4-8 0.75

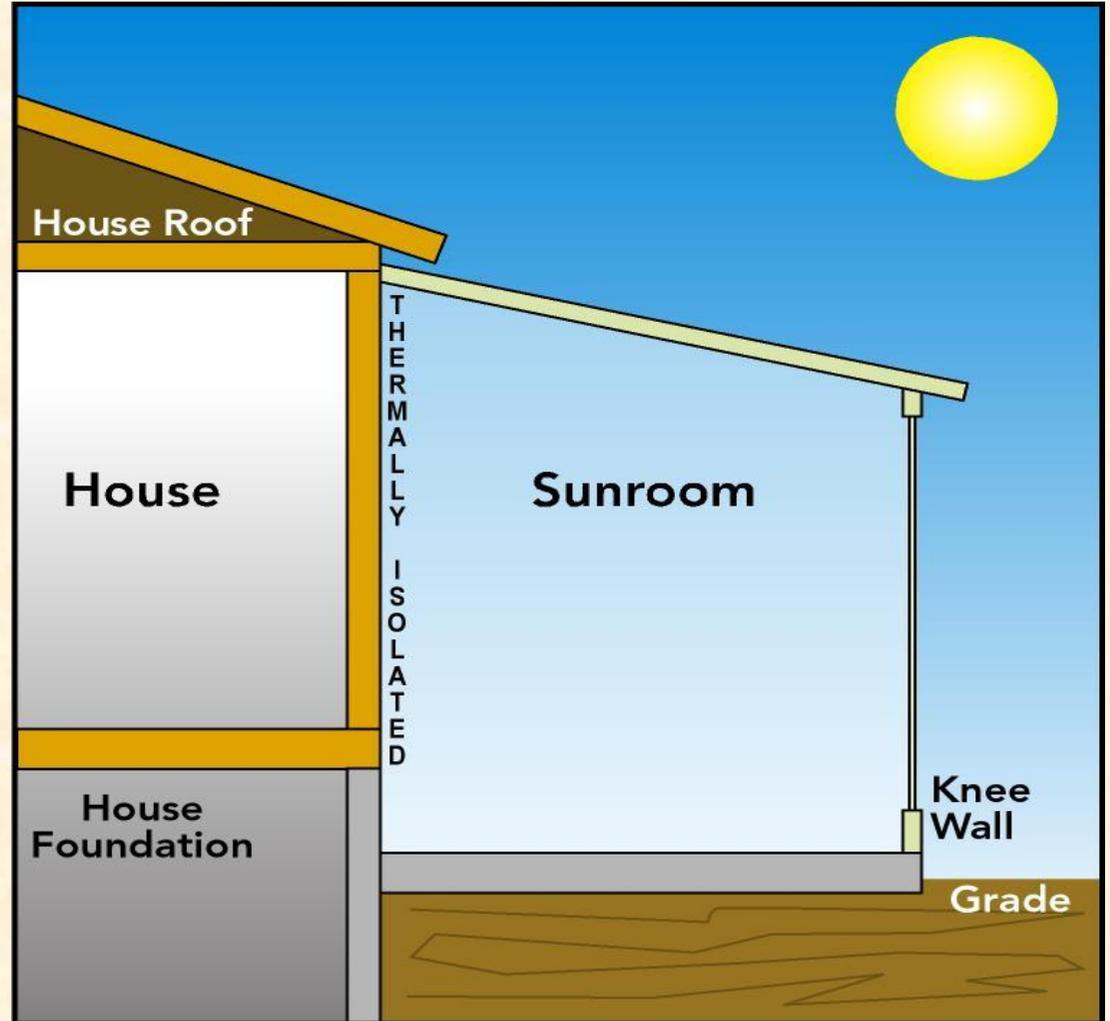

References

- The majority of slides were obtained and modified to fit local conditions from the U.S. Department of Energy Building Energy Codes Program presentations available at <http://www.energycodes.gov/training/presentations.stm>
- Yost, Y. and J. Lstiburek. 2002. *Basement Insulation Systems*. Building Sciences Corporation

Questions?

Carl Pedersen

www.ndsu.edu/energy

Carl.pedersen@ndsu.edu

(701) 231-5833

