

REAR ELEVATION
COMBINATION ROOF

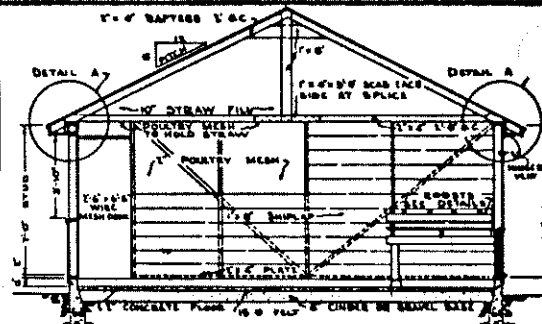

CROSS SECTION - STRAW LOFT TYPE

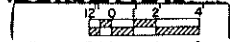
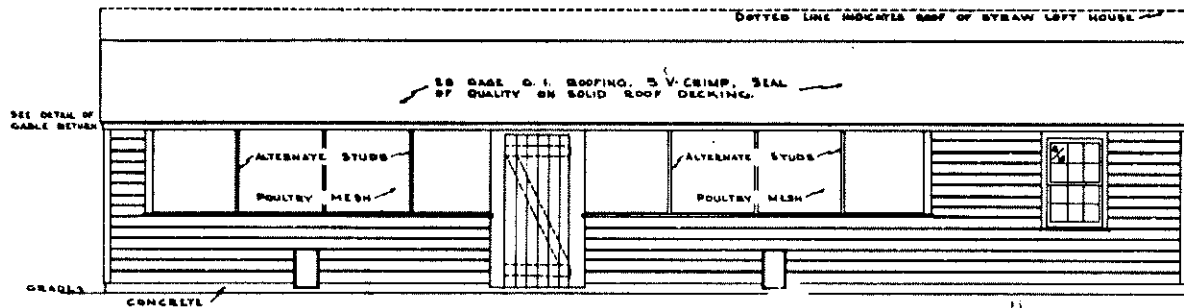
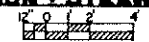

FRONT ELEVATION
COMBINATION ROOF & STRAW LOFT TYPES

SCALE: 1/8" = 1'-0"

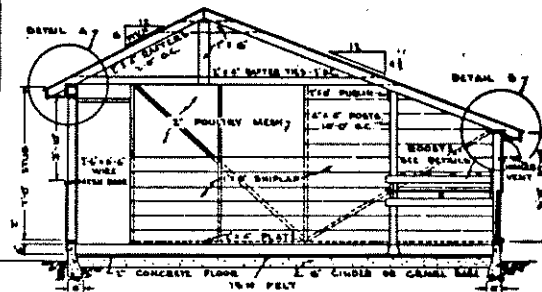

CROSS SECTION - COMBINATION ROOF

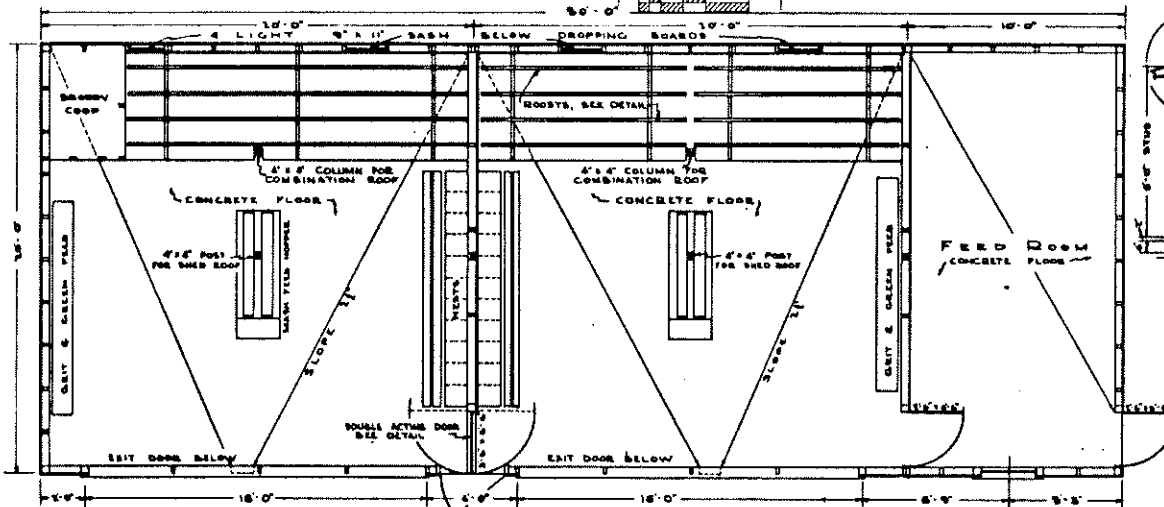

FLOOR PLAN

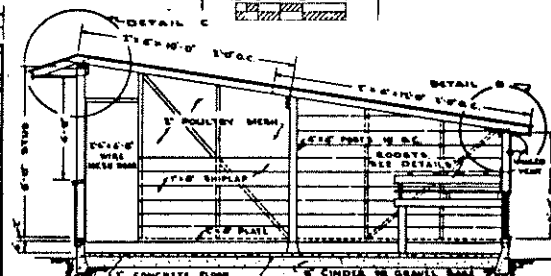
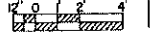

CROSS SECTION - SHED ROOF



COOPERATIVE EXTENSION WORK IN
AGRICULTURE AND HOME ECONOMICS

AND
U.S. DEPT. OF AGRICULTURE COOPERATING

POULTRY HOUSE

GA. EX. 5582 SHEET 1 OF 2

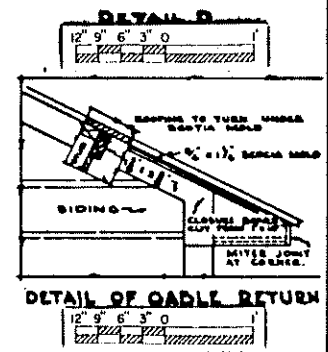
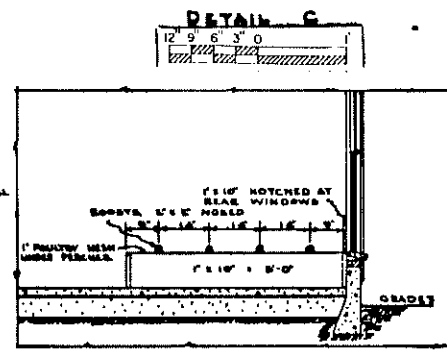
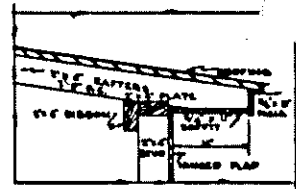
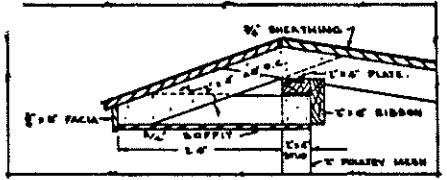
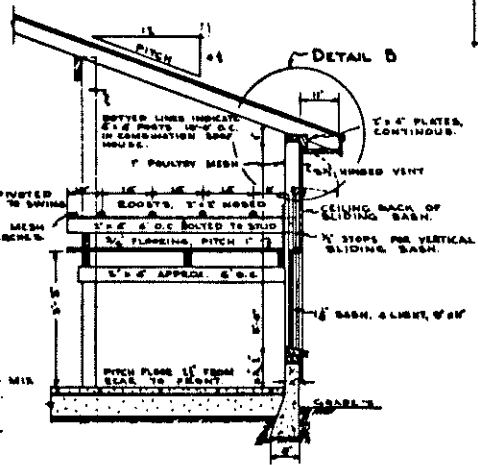
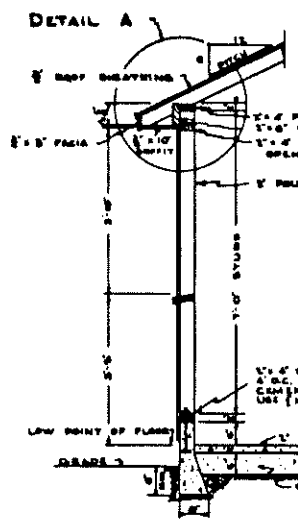

TYPICAL WALL SECTIONS

ALTERNATE ROOST DETAIL

DETAIL OF CABLE RETURN

NOTE:
ALL WALL AND ROOF FRAMING 2'-0" O.C.
UNLESS OTHERWISE SPECIFIED.

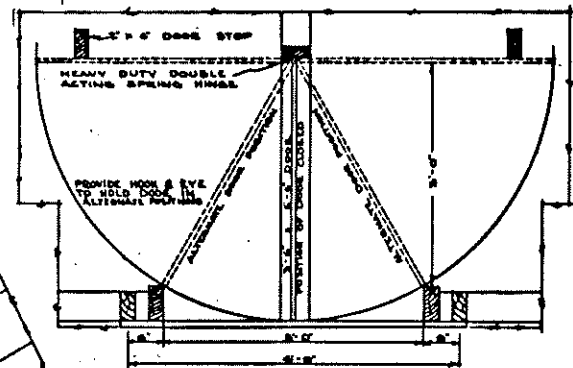

DETAIL OF DOUBLE ACTION DOOR

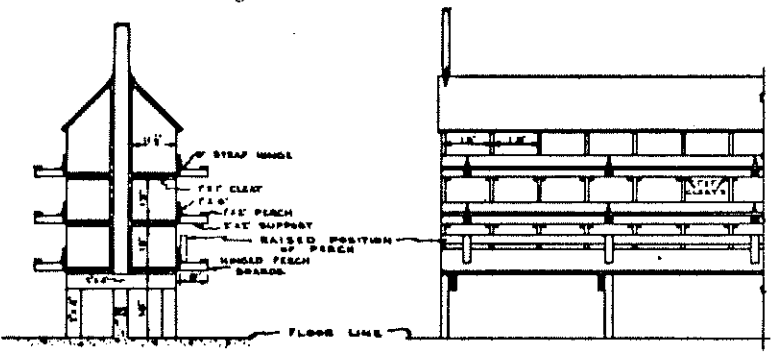

SECTION VIEW

FRONT VIEW

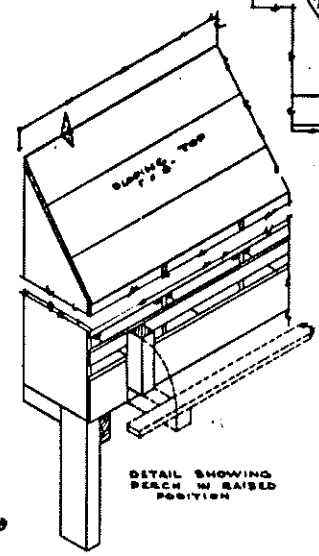

DETAIL SHOWING PERCH IN RAISED POSITION

NEST DETAILS
LOOSE BOTTOMS

COOPERATIVE EXTENSION WORK IN
AGRICULTURE AND HOME ECONOMICS

AND
U. S. DEPT. OF AGRICULTURE COOPERATING

POULTRY HOUSE

GA. Ex. 5582 SHEET 2 OF 2