

TYPE-A

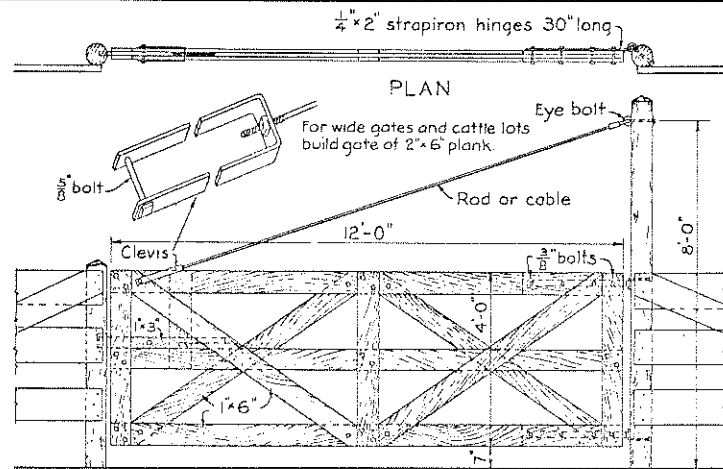

Block 18" long bolted to post
TYPE-D

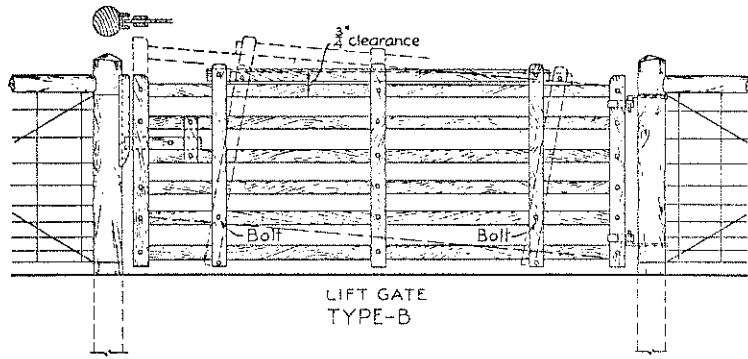

LIFT GATE
TYPE-B

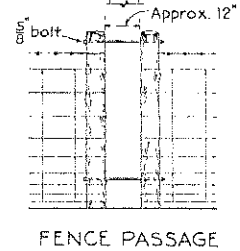
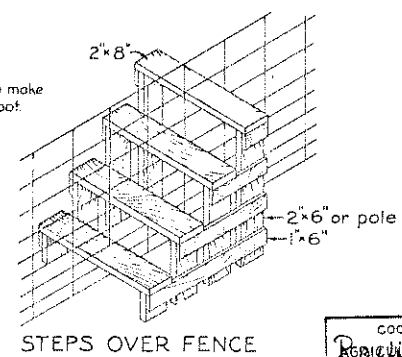
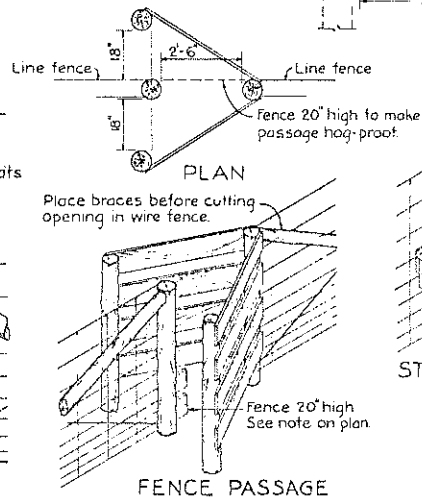
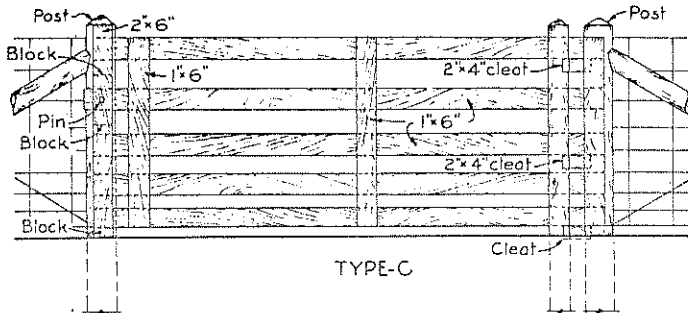
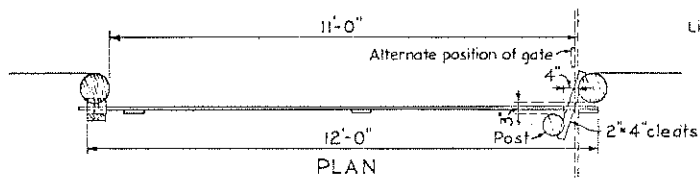
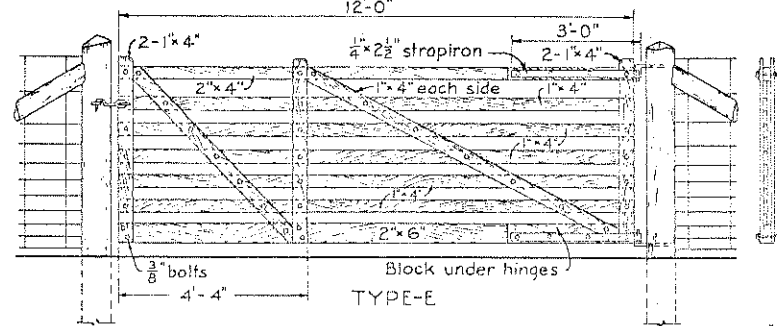

COOPERATIVE EXTENSION WORK IN
RURAL LIFE AND HOME ECONOMICS
DEPARTMENT OF AGRICULTURAL ENGINEERING
UNIVERSITY OF MARYLAND
AND
U. S. DEPT. OF AGRICULTURE COOPERATING