

**TYPICAL GATE**

**TYPICAL CONSTRUCTION DETAILS**

SCALE: 1/4" = 1'-0"

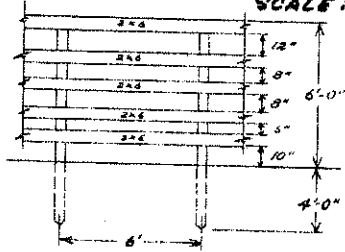

**TYPICAL LINE FENCE**

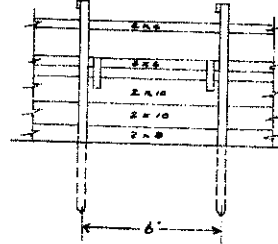

**TYPICAL CHUTE**

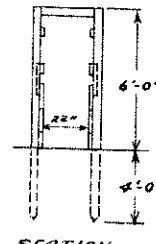

SECTION

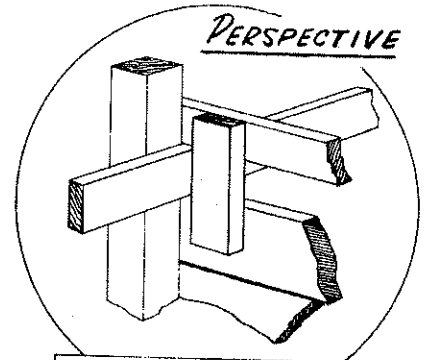

PERSPECTIVE

SLOT FOR CROSSBAR  
BLOCKING GATE

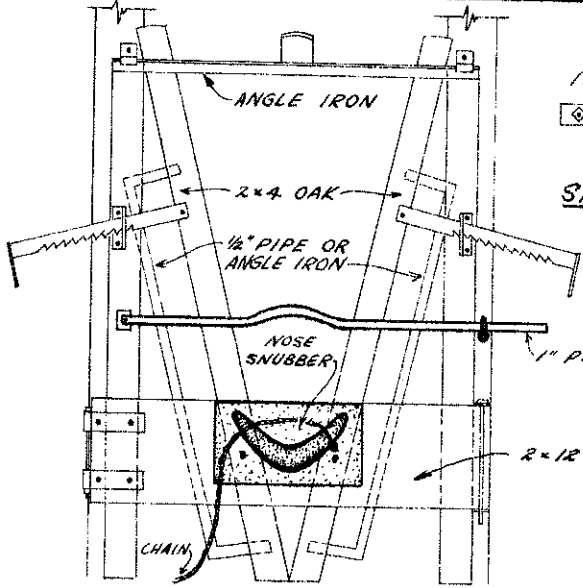

**HEAD GATE DETAIL**

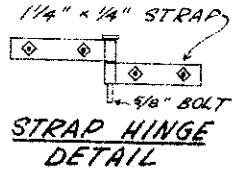

STRAP HINGE  
DETAIL

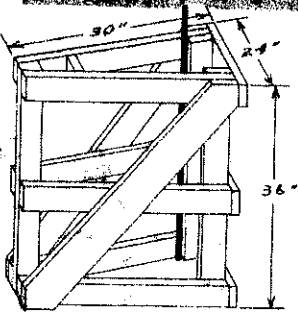

**BLOCKING GATE**

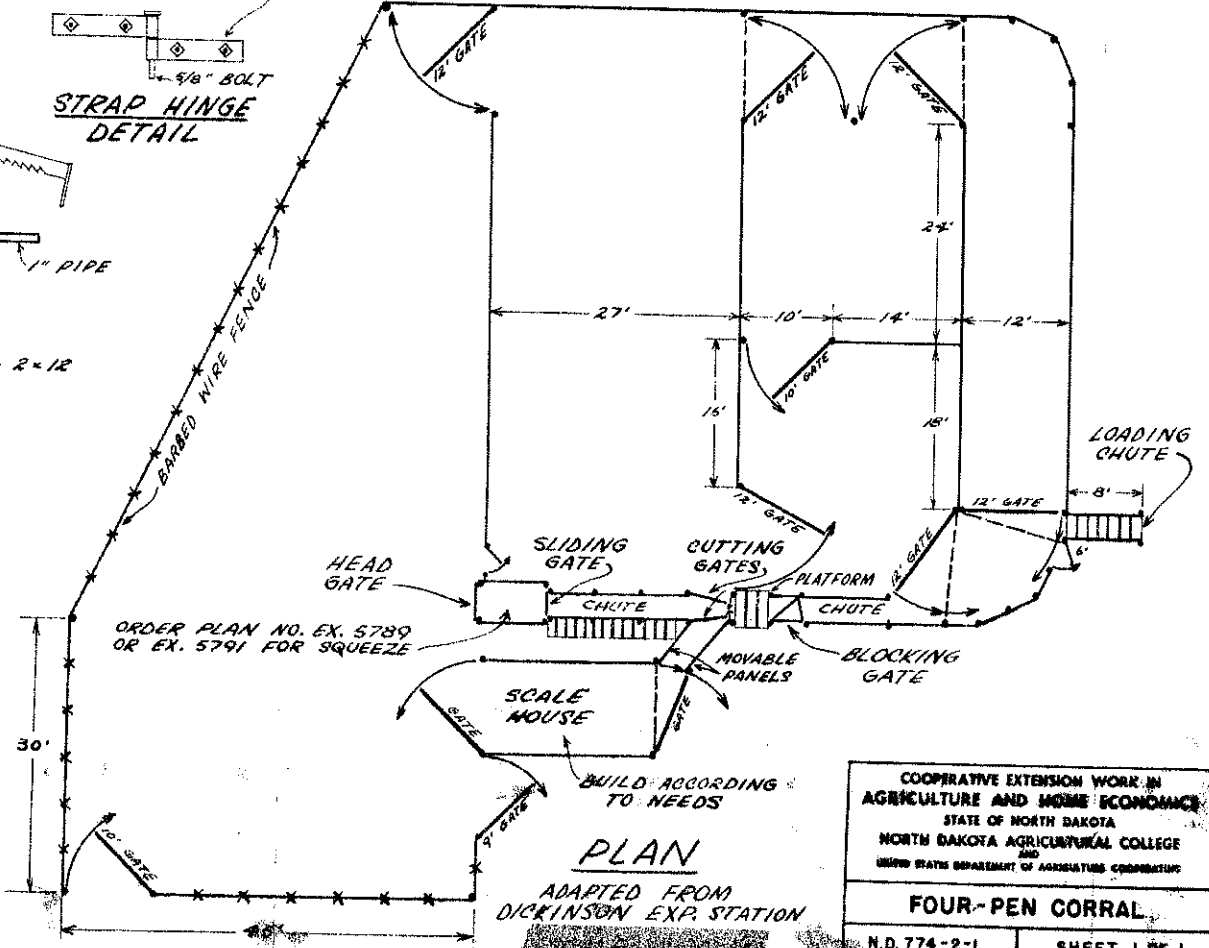

COOPERATIVE EXTENSION WORK IN  
AGRICULTURE AND HOME ECONOMICS  
STATE OF NORTH DAKOTA  
NORTH DAKOTA AGRICULTURAL COLLEGE  
AND  
UNIVERSITY OF NORTH DAKOTA  
**FOUR-PEN CORRAL**  
N.D. 774-2-1 SHEET 1 OF 1  
W. B. RANS, Jr. by R. C. Circo 1952

Revised 13"