

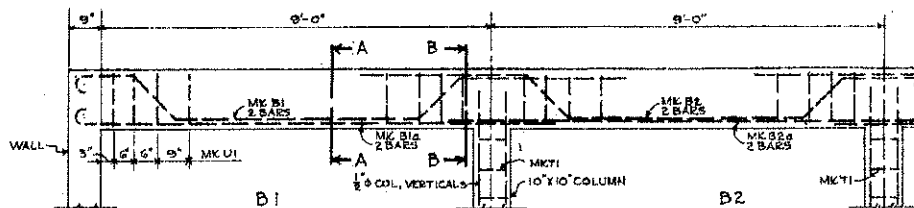



BEAM SCHEDULE

BEAM		STRAIGHT BARS				BENT BARS				STIRRUPS					
MARK	NO.	SIZE	MARK	NO.	SIZE	LENGTH	MARK	NO.	SIZE	LENGTH	MARK	NO.	SIZE	LENGTH	SPACING
B1	4	10'x16'	B1a	2	3/8"	11'-3"	B1	2	3/8"	14'-3"	U1	8	3/8"	3'-5"	3'-6"-6'-9"
B2	4	10'x16'	B2a	2	3/8"	11'-0"	B2	2	3/8"	15'-2"	U1	8	3/8"	3'-5"	3'-6"-6'-9"



SLAB BARS

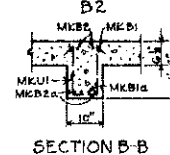
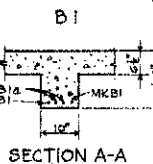
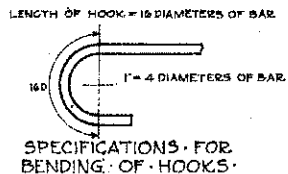
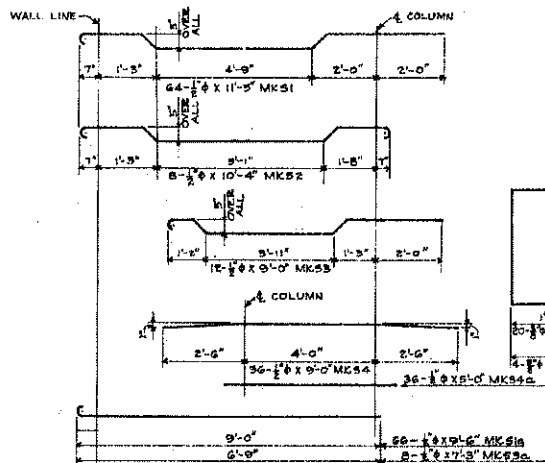

DETAIL OF BEAMS B1 & B2  
SCALE 1/2" = 1'-0"

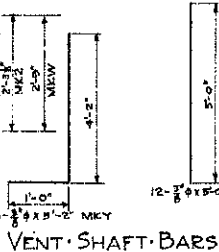

VENT SHAFT BARS

DETAIL OF COLUMN & FOOTING  
SCALE 1/2" = 1'-0"

COLUMN SECTION  
SCALE 1/2" = 1'-0"

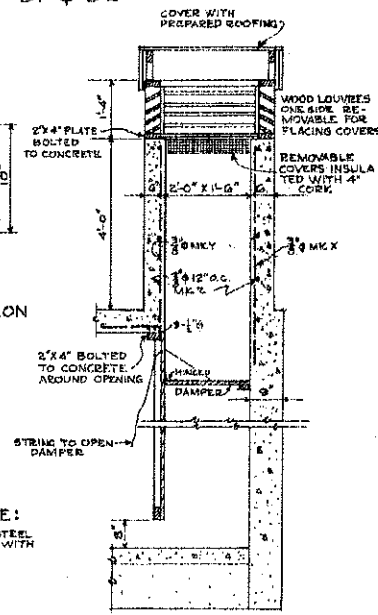

VERTICAL SECTION THRU VENTILATION INTAKE SHAFT  
SCALE 1/2" = 1'-0"

BEAM BARS

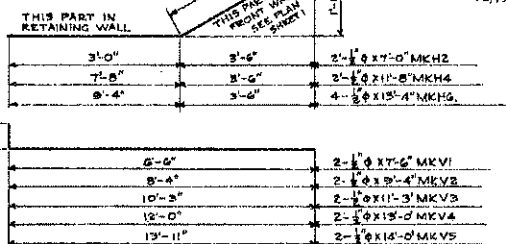
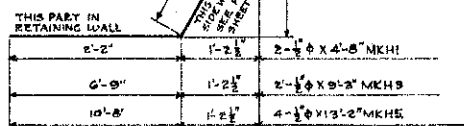
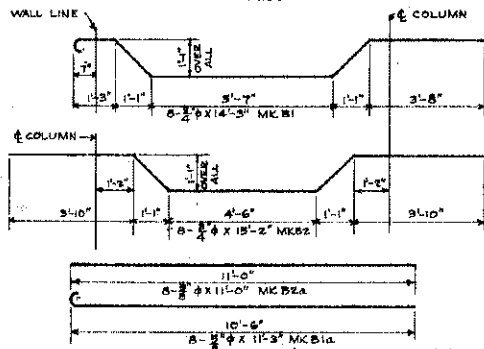

RETAINING WALL BARS

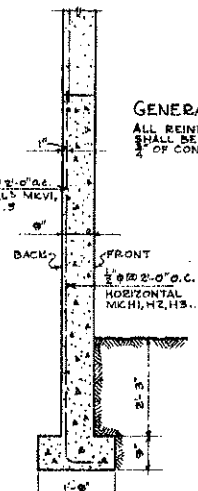

SECTION THRU RETAINING WALL  
SCALE 1/2" = 1'-0"

GENERAL NOTE:  
ALL REINFORCING STEEL SHALL BE COVERED WITH 3" OF CONCRETE.

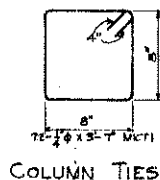

STIRRUPS

ARK. ILL. IND. IOWA KAN. KY. MICH. MINN. MO. NEB. N. D. OHIO OKLA. S. D. WIS.	COOPERATIVE EXTENSION WORK IN AGRICULTURE AND HOME ECONOMICS	
	STATE OF NORTH DAKOTA	
	NORTH DAKOTA AGRICULTURAL COLLEGE	
	AND U. S. DEPT. OF AGRICULTURE COOPERATING EXT. AGR. ENGINEER - FARGO, N. DAK.	
FRUIT & VEGETABLE STORAGE		SHEET 3 OF 3 SHEETS
MID-WEST PLAN NO. 73401		