

INTERIOR VIEW: CUTTING WINDOW OPENINGS IN SHEATHING

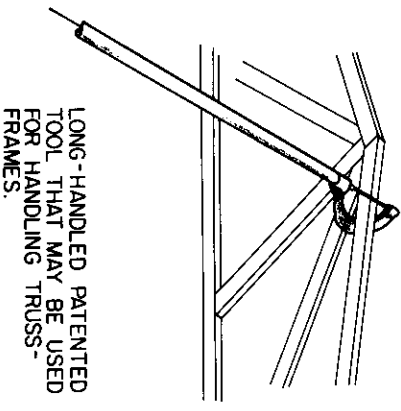

LONG-HANDLED PATENTED TOOL THAT MAY BE USED FOR HANDLING TRUSS-FRAMES.

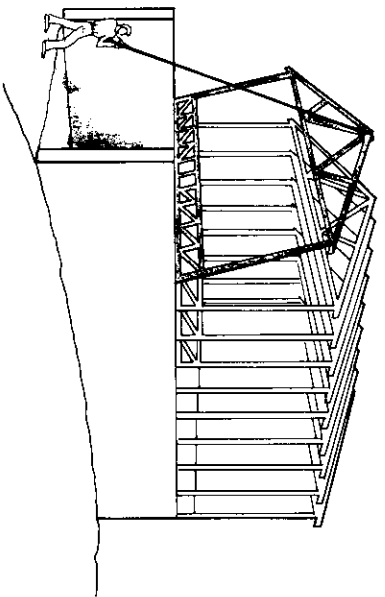

TILTING TRUSS-FRAMES IN PLACE

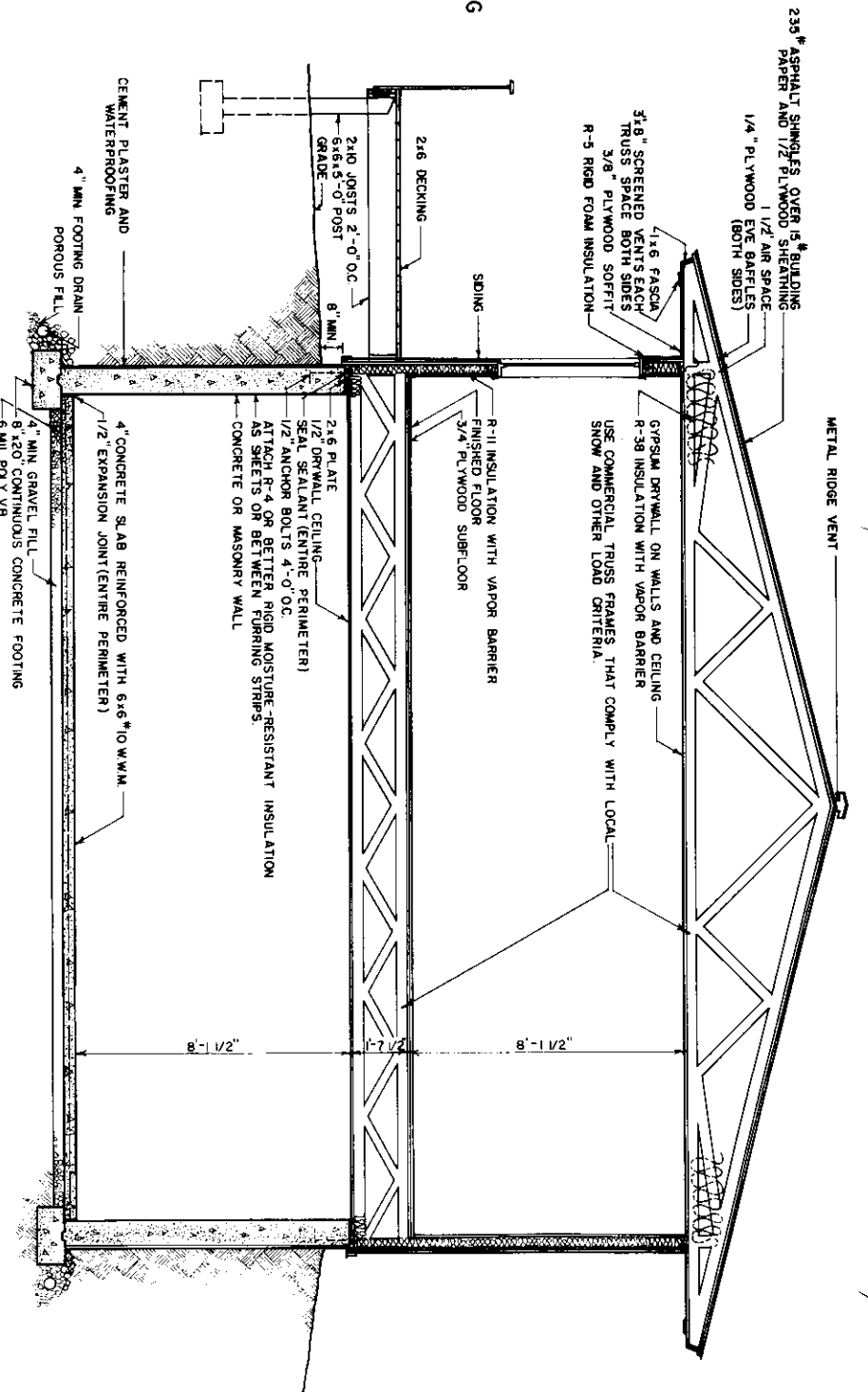

TYPICAL SECTION

1/2" 6" 0 1' 2' 3" SCALE  
(ALL OTHER DRAWINGS - NO SCALE)

ARRANGEMENT OF TRUSS MEMBER(S) MAY VARY WITH MANUFACTURER

ADAPTED FROM RESEARCH DEVELOPED BY THE FOREST PRODUCTS LABORATORY, FOREST SERVICE, USDA.

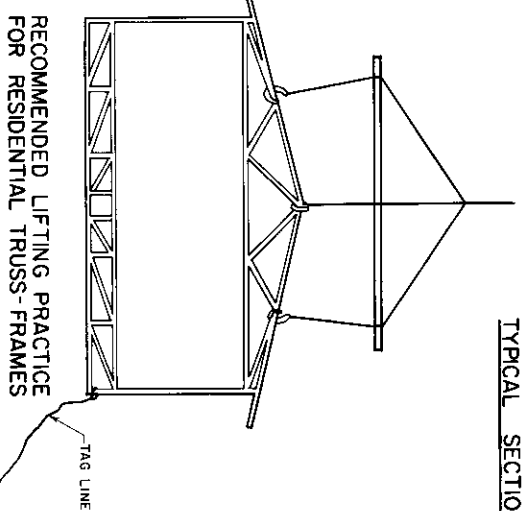

RECOMMENDED LIFTING PRACTICE FOR RESIDENTIAL TRUSS-FRAMES

COOPERATIVE EXTENSION SERVICE AGRICULTURE AND HOME ECONOMICS			
UNITED STATES DEPARTMENT OF AGRICULTURE COOPERATING			
TRUSS FRAME CONSTRUCTION IN HOUSING			
USDA 85	7261	SHEET 1 OF 3	

TYPICAL APPLICATION OF TRUSS FRAME CONSTRUCTION IN HOUSING

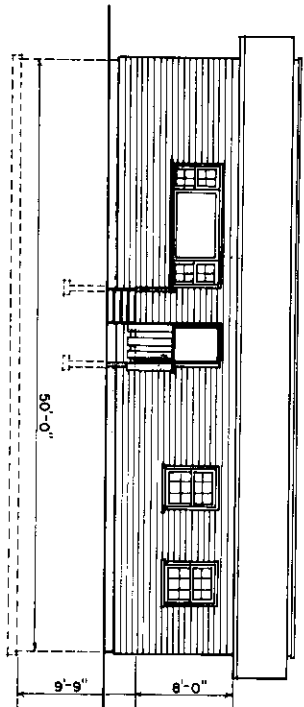

FRONT ELEVATION

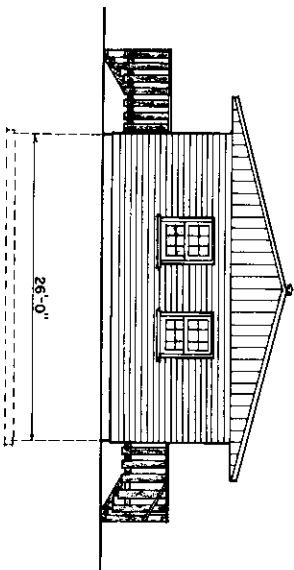

RIGHT ELEVATION

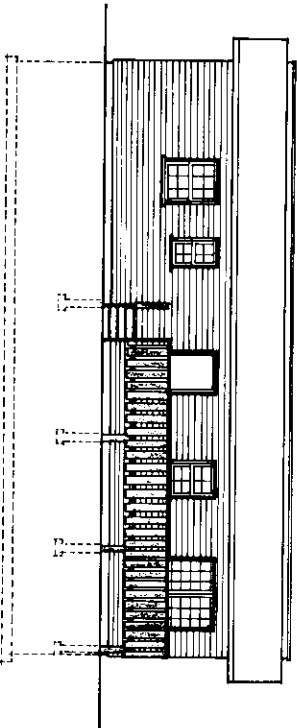

REAR ELEVATION

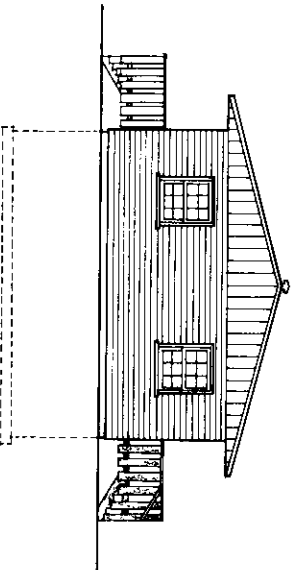

LEFT ELEVATION

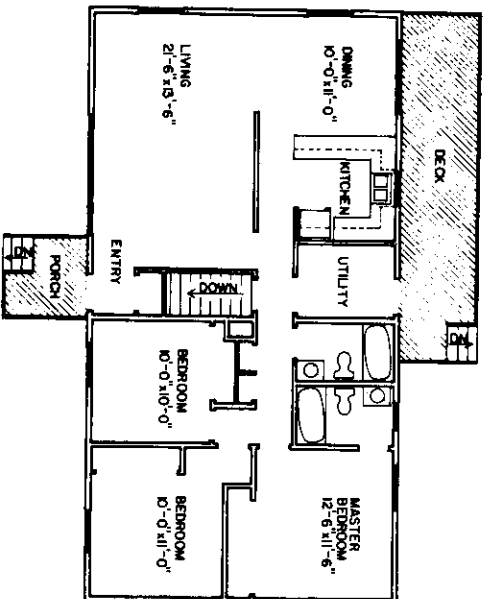

FLOOR PLAN

CONSTRUCTION CHECK LIST

1. CHECK LOCAL BUILDING CODE AND LOAN COMPANY CRITERIA.
2. ADEQUATELY NAIL AND ANCHOR JOINTS.
3. SHEATH CORNERS WITH 1/2" PLYWOOD OR HIGH DENSITY FIBERBOARD OR USE DIAGONAL BRACING.
4. USE EXTERIOR GRADED PLYWOOD WHEREVER IT MAY BE WETTED DURING OR AFTER CONSTRUCTION.
5. PRESSURE TREAT ALL WOOD WITH GROUND CONTACT AND PROVIDE OTHER NEEDED TREATMENT CONTROL.
6. R VALUES DEPEND ON LOCAL CLIMATE AND FUEL COSTS.
7. PROVIDE 1 SQ FT OF ATTIC VENT OPENINGS FOR EACH 150 SQ FT OF CEILING.
8. WEATHERIZE ALL OPENINGS AND JOINTS.
9. THE COMPLETE FLOOR, WALL, AND ROOF TRUSS SYSTEM WILL NORMALLY BE CONSTRUCTED BY A TRUSS MANUFACTURER. THE THREE COMPONENTS MAY BE ASSEMBLED AT THE FACTORY OR ON SITE.
10. NORMALLY, THE BUILDING WILL BE COMPLETELY SHEATHED BEFORE LOCATING WINDOWS AND DOORS.
11. INSTALL HEADERS FOR WINDOWS AND DOORS BEFORE CUTTING OPENINGS IN SHEATHING AND STUDS. HEADERS ARE NOT NEEDED WHEN WINDOWS FIT BETWEEN STUDS, LESS THAN 22 1/2" WIDE.

ALL DRAWINGS  
 1/8" = 1'-0"  
 SCALE

COOPERATIVE EXTENSION SERVICE  
 AGRICULTURE AND HOME ECONOMICS

UNITED STATES DEPARTMENT OF AGRICULTURE COOPERATING  
 TRUSS FRAME CONSTRUCTION  
 IN HOUSING

USDA 85 7261 SHEET 2 OF 3

OTHER EXAMPLES OF FLOOR PLANS

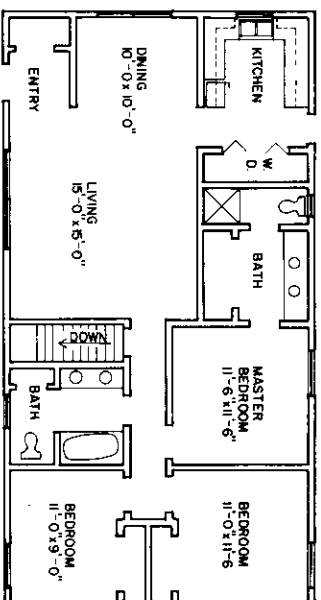

ALTERNATE A: 50'x26', 3 BEDROOM - 2 BATH

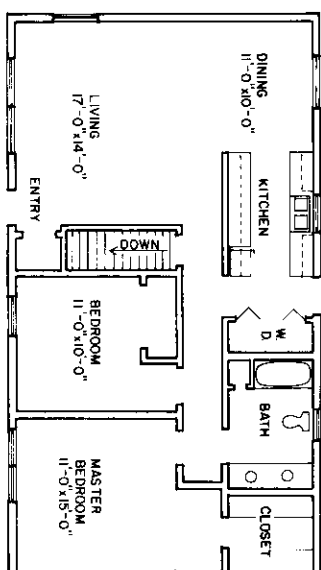

ALTERNATE D: 48'x26', 2 BEDROOM - 1 BATH

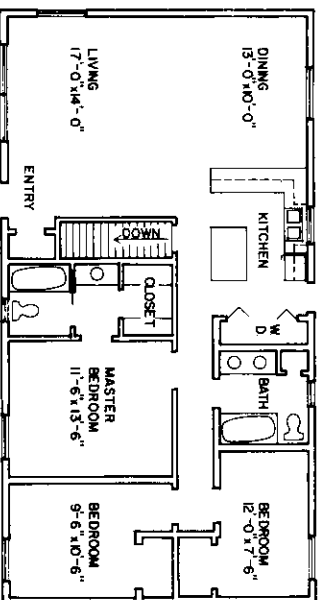

ALTERNATE B: 50'x26', 3 BEDROOM - 2 BATH

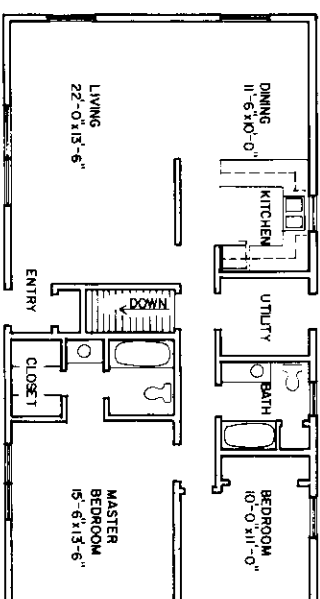

ALTERNATE E: 50'x26', 2 BEDROOM - 2 BATH

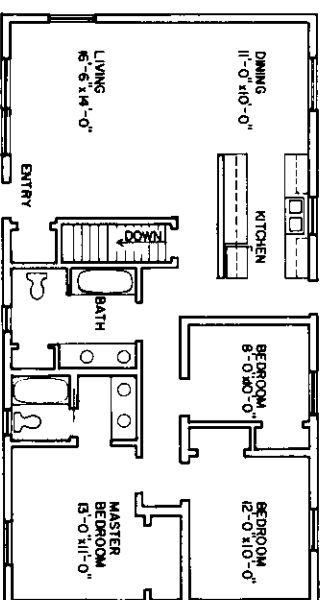

ALTERNATE C: 50'x26', 3 BEDROOM - 2 BATH

THERE ARE MANY VARIATIONS IN FLOOR PLANS THAT CAN BE WORKED OUT WITH THIS BASIC FRAMING CONCEPT. KEEP IN MIND THAT THE TRUSS MAY BE CONSTRUCTED IN WIDER WIDTHS THAN SHOWN AND THAT THE HOUSE LENGTH CAN BE CHANGED BY INCREMENTS OF 2 FEET. BASEMENT ACCESS IS SIMPLER TO CONSTRUCT WHEN ONLY ONE FLOOR TRUSS NEEDS TO BE CUT. PLAN WINDOWS TO FIT BETWEEN TRUSSES SO THAT THE FEWEST POSSIBLE TRUSSES NEED TO BE CUT. WHEN SELECTING ROOM LOCATIONS CONSIDER TRAFFIC FLOW BETWEEN ROOMS, CONVENIENCE FOR BRINGING IN FOOD OR DOING LAUNDRY, PRIVACY OF SLEEPING AREAS AND BATH, AND ORIENTATION OF WINDOWS WITH RESPECT TO SUN, AIR MOVEMENT AND VIEW.

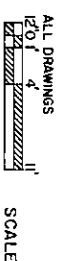

SCALE

COOPERATIVE EXTENSION SERVICE  
AGRICULTURE AND HOME ECONOMICS

UNITED STATES DEPARTMENT OF AGRICULTURE COOPERATING  
TRUSS FRAME CONSTRUCTION  
IN HOUSING

USDA 85 7261 SHEET 3 OF 3