

WINDOW SCHEDULE			
MARK	SIZE	DESCRIPTION	QUANTITY
①	4'-4" x 3'-8"	ALUMINUM DOUBLE HUNG	9
②	3'-2" x 3'-8"	ALUMINUM DOUBLE HUNG	4

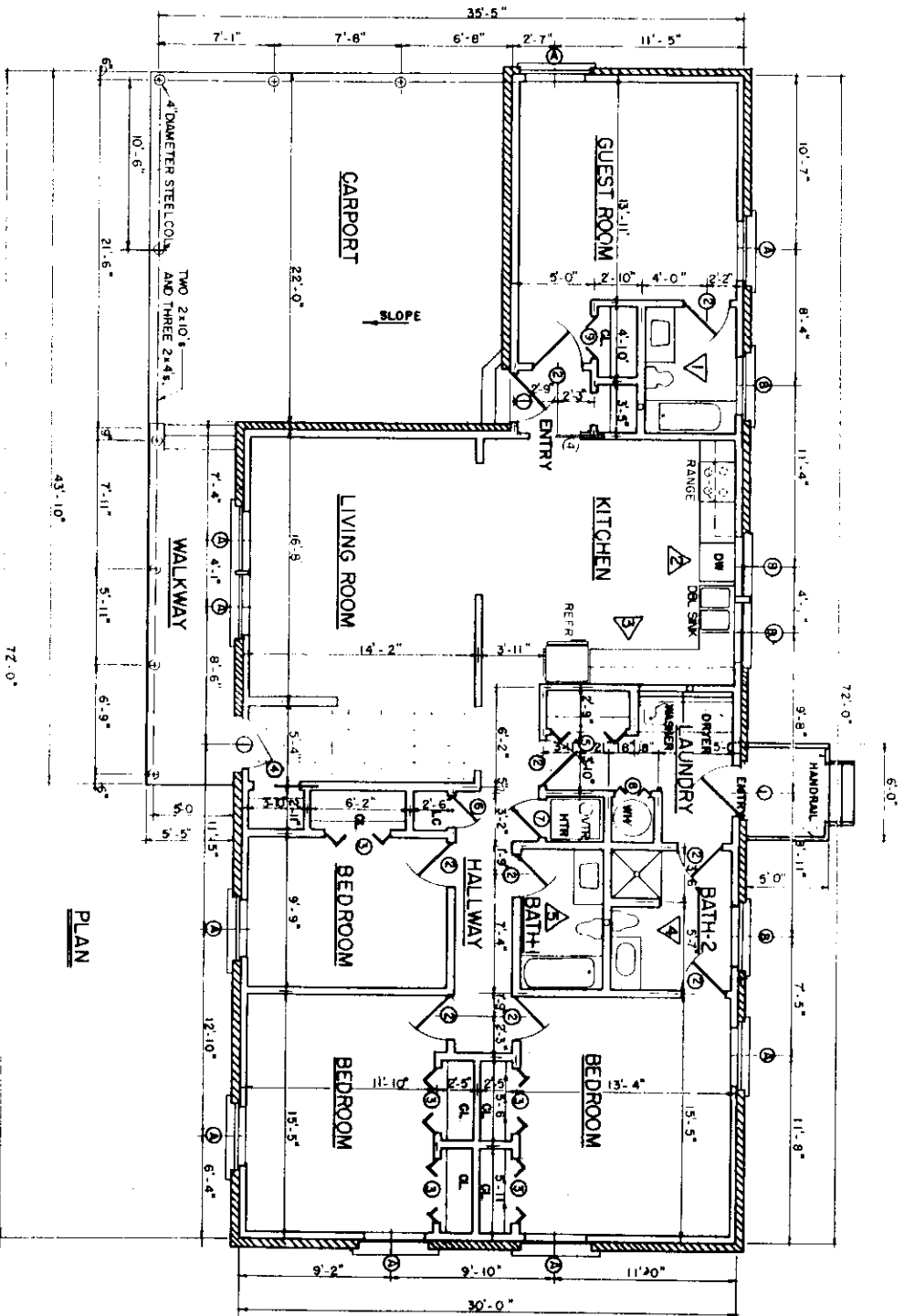

PLAN

DOOR SCHEDULE			
MARK	SIZE	TYPE	QUANTITY
①	3'-0" x 6'-8"	SOLID CORE WOOD - EXTERIOR	1
②	2'-6" x 6'-8"	HOLLOW CORE WOOD - INTERIOR	9
③	4'-0" x 6'-8"	HOLLOW CORE WOOD - INTERIOR	5
④	2'-6" x 6'-8"	WOOD BIFOLD	1
⑤	4'-6" x 6'-8"	WOOD SLIDING	1
⑥	2'-0" x 6'-8"	PLYWOOD	1
⑦	2'-6" x 6'-8"	HOLLOW CORE WOOD - INTERIOR WALKWAY	1
⑧	2'-0" x 6'-8"	WOOD BIFOLD	1
⑨	2'-6" x 6'-8"	WOOD BIFOLD	1



CONSULT LOCAL BUILDING CODE  
AUTHORITIES BEFORE STARTING  
ANY TYPE OF CONSTRUCTION

BASED ON ARKANSAS PLAN NO 737702

COOPERATIVE EXTENSION WORK IN  
AGRICULTURE AND HOME ECONOMICS

UNITED STATES DEPARTMENT OF AGRICULTURE COOPERATING  
AND  
THREE BEDROOM HOUSE WITH  
GUEST ROOM

USDA 77 7217 SHEET 1 OF 4

REVISED 6/783

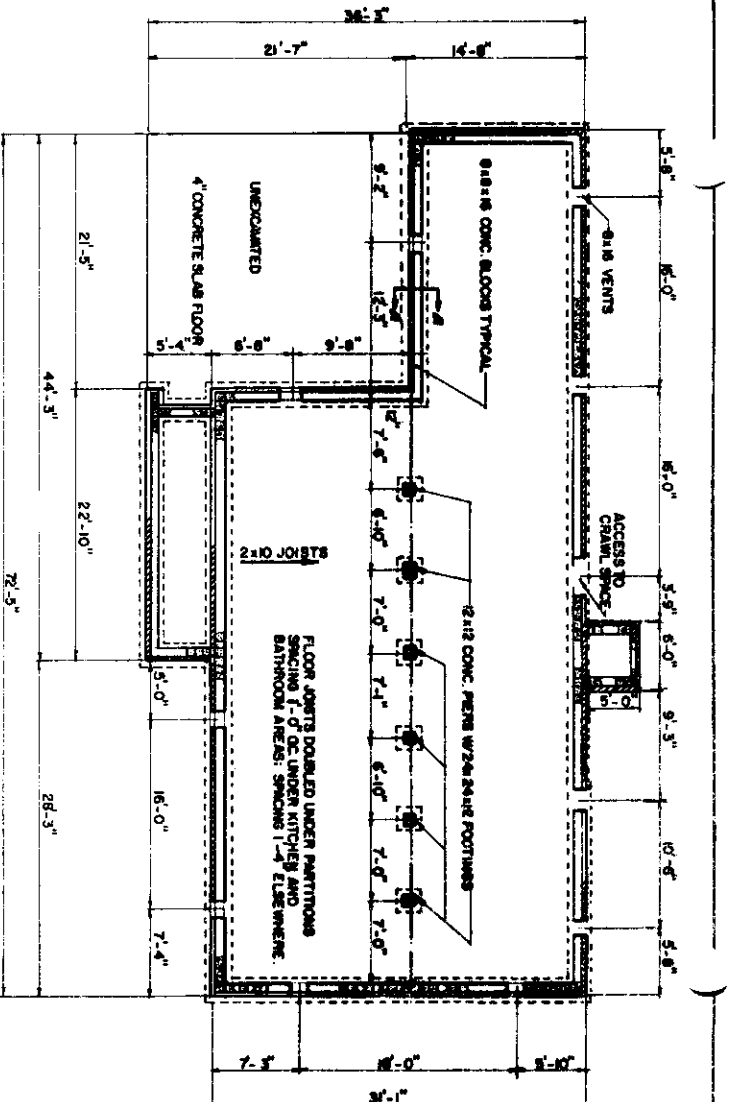

FOUNDATION PLAN

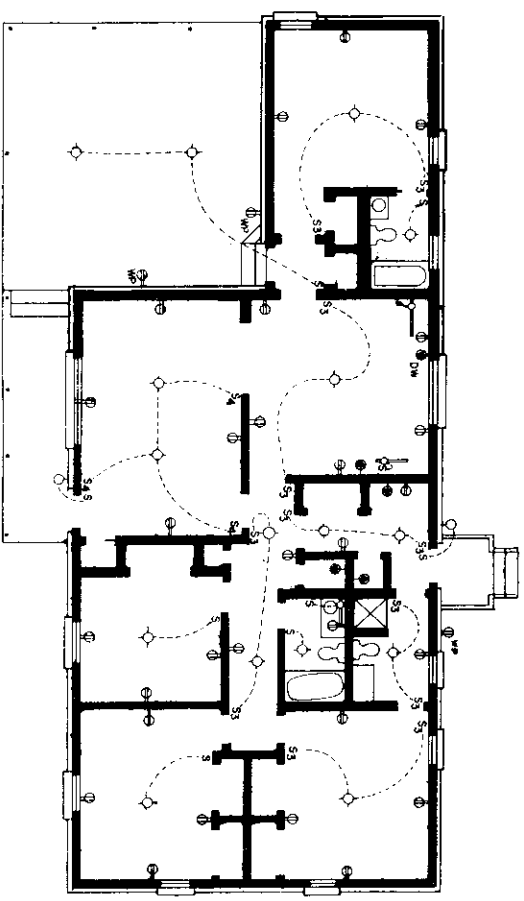

ELECTRICAL PLAN

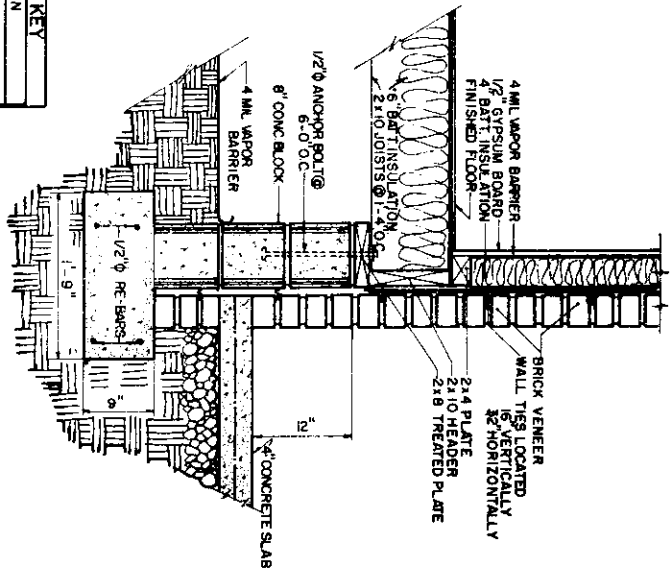

SECTION A-A

MARK	DESCRIPTION
FR	FRAME
W	WOOD
C	CONCRETE
I	INSULATION
G	GRAVEL
E	EARTH

ELECTRICAL KEY

S	SINGLE POLE SWITCH
3S	THREE WAY SWITCH
4S	FOUR WAY SWITCH
SP	SPECIAL PURPOSE OUTLET
CH	DOOR CHIMES
WR	WATERPROOFED OUTLET
FO	FLUORESCENT OUTLET
CO	CEILING OUTLET
WO	WALL OUTLET
DO	DUPLEX CONVENIENCE OUTLET

COOPERATIVE EXTENSION WORK IN  
 AGRICULTURE AND HOME ECONOMICS  
 UNITED STATES DEPARTMENT OF AGRICULTURE COOPERATING  
 AND  
 THREE BEDROOM HOUSE WITH  
 GUEST ROOM  
 USDA '77 7217 SHEET 2 OF 4

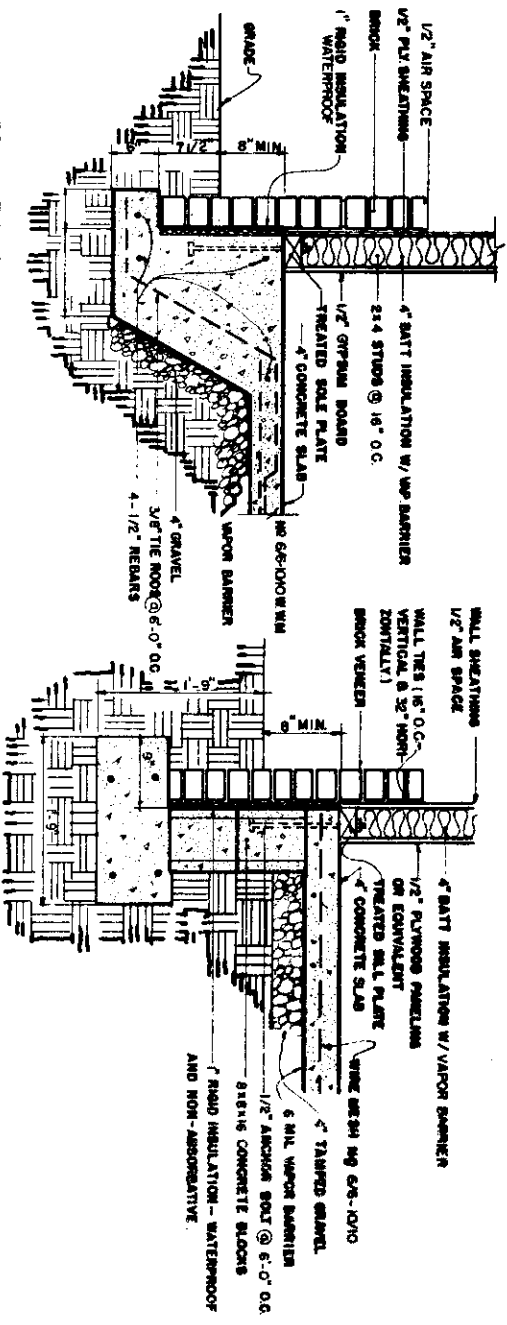

FOUNDATION / WALL SECTION 1

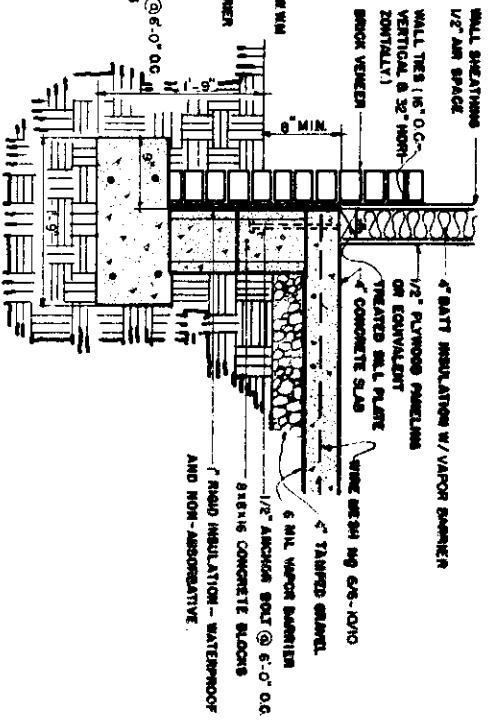

FOUNDATION / WALL SECTION 2

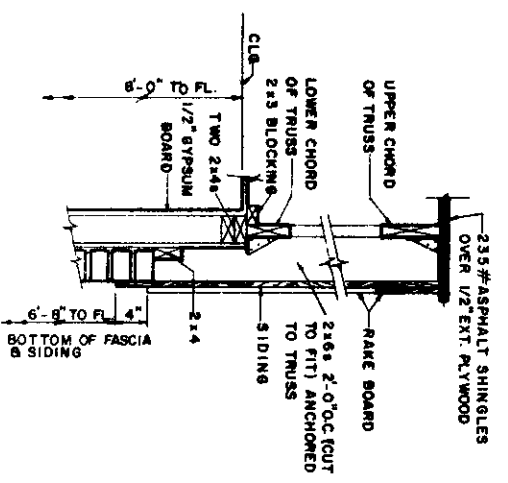

SECTION GABLE ENDS

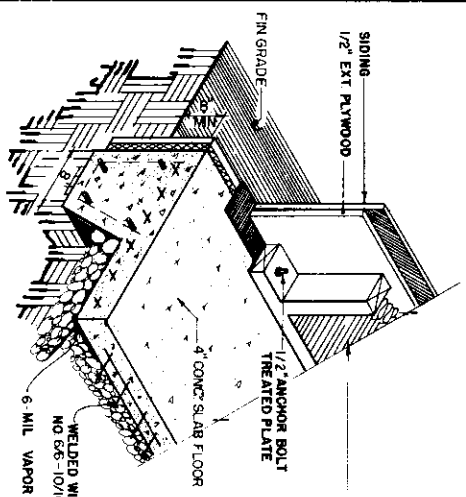

FOUNDATION / WALL SECTION 3

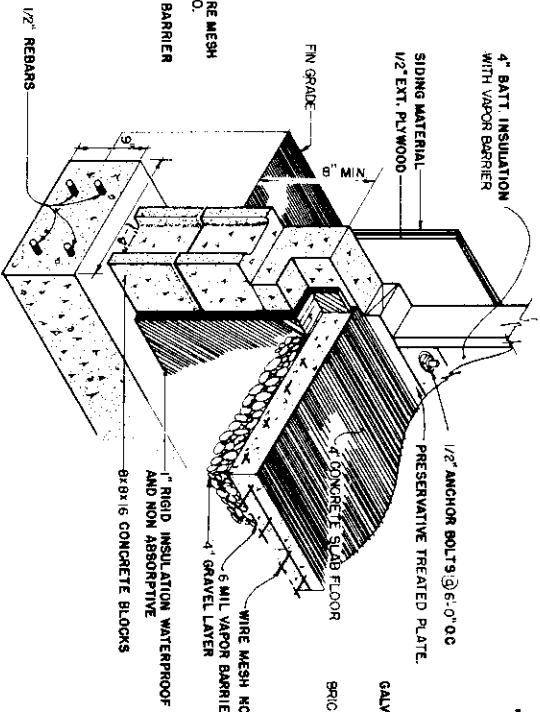

FOUNDATION / WALL SECTION 4

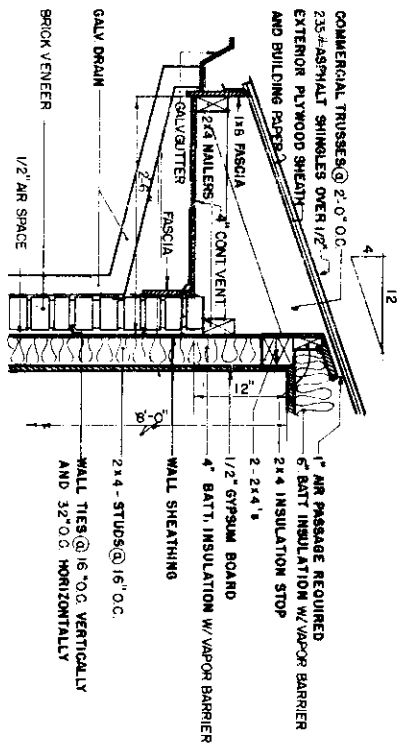

ROOF SECTION TYPICAL



ALTERNATE WALL SECTIONS & FOUNDATIONS

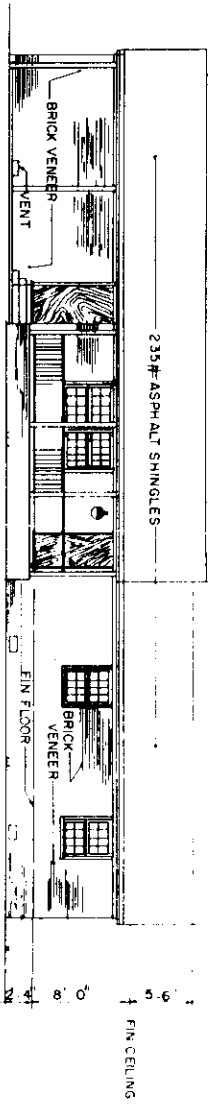

FRONT ELEVATION

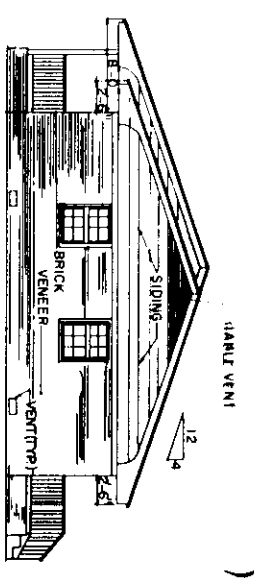

RIGHT ELEVATION

EXTERIOR ELEVATIONS

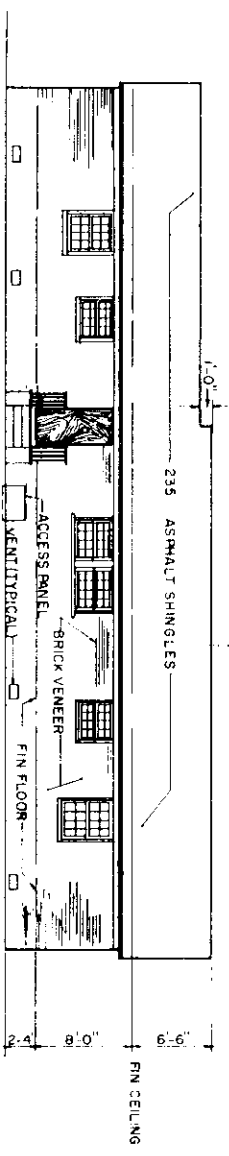

REAR ELEVATION

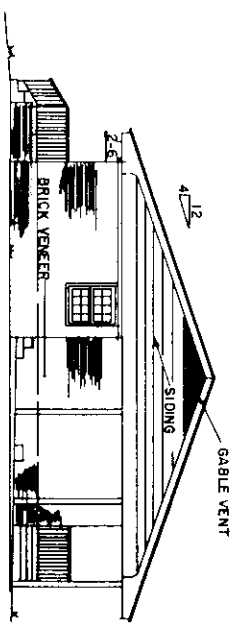

LEFT ELEVATION

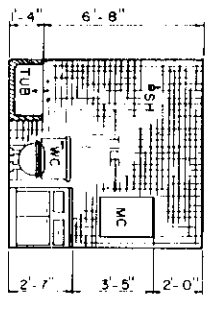

DETAIL-1

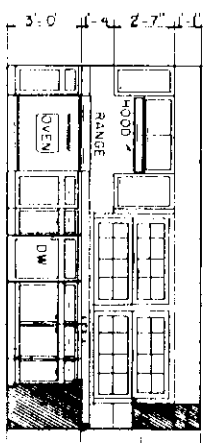

DETAIL-2

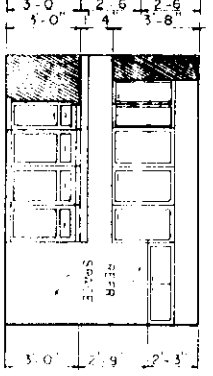

DETAIL-3

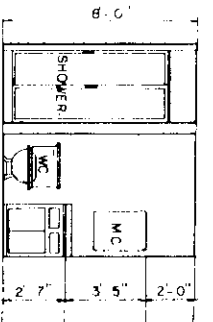

DETAIL-4

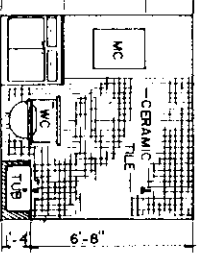

DETAIL-5

INTERIOR DETAILS

- WC WATER CLOSET
- MC MEDICINE CABINET
- SH SHOWER HEAD
- DW DISHWASHER



COOPERATIVE EXTENSION WORK IN  
 AGRICULTURE AND HOME ECONOMICS

UNITED STATES DEPARTMENT OF AGRICULTURE COOPERATING  
 AND  
 NATIONAL AGRICULTURAL MECHANIZATION ADMINISTRATION

THREE BEDROOM HOUSE WITH  
 GUEST ROOM

USDA 77 7217 SHEET 4 OF 4  
 REVISED 6/83