

DESIGNED BY
FOREST PRODUCTS LABORATORY
MADISON, WISCONSIN
FS-FPL 4

COOPERATIVE EXTENSION WORK IN
AGRICULTURE AND HOME ECONOMICS

UNITED STATES DEPARTMENT OF AGRICULTURE COOPERATING
AND
FOUR BEDROOM HOUSE
FRAME CONSTRUCTION
USDA 70 7188 SHEET 1 OF 5

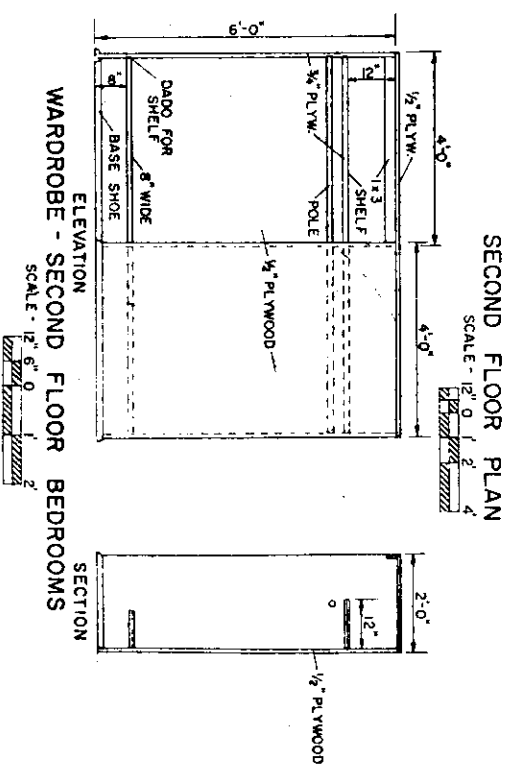

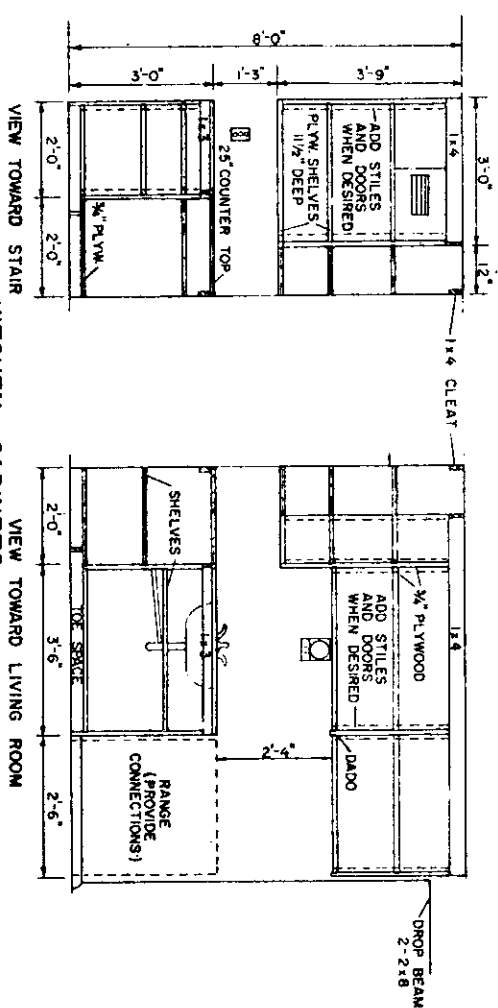
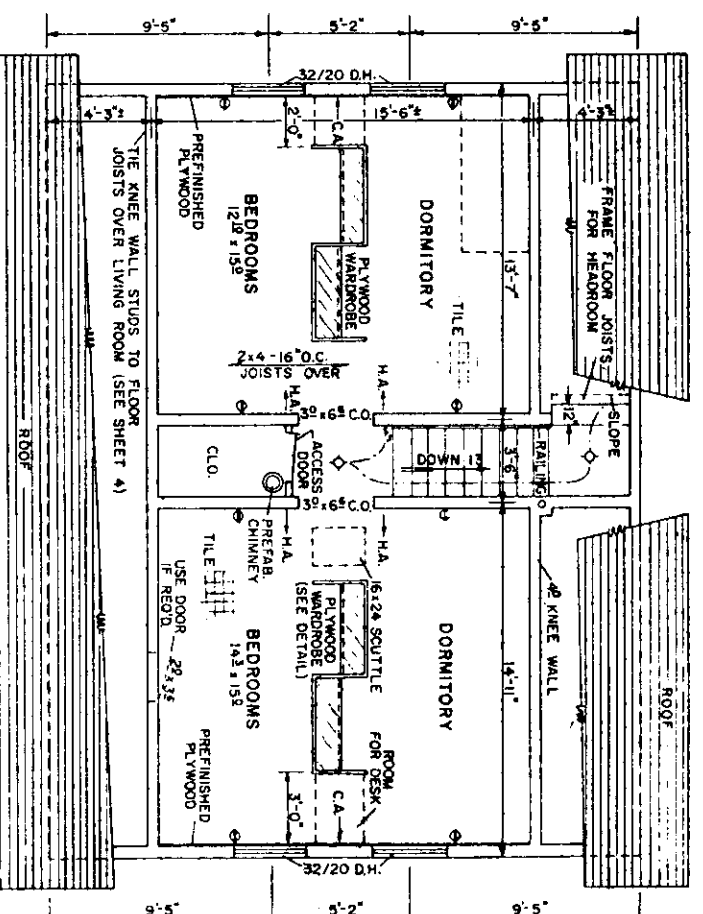
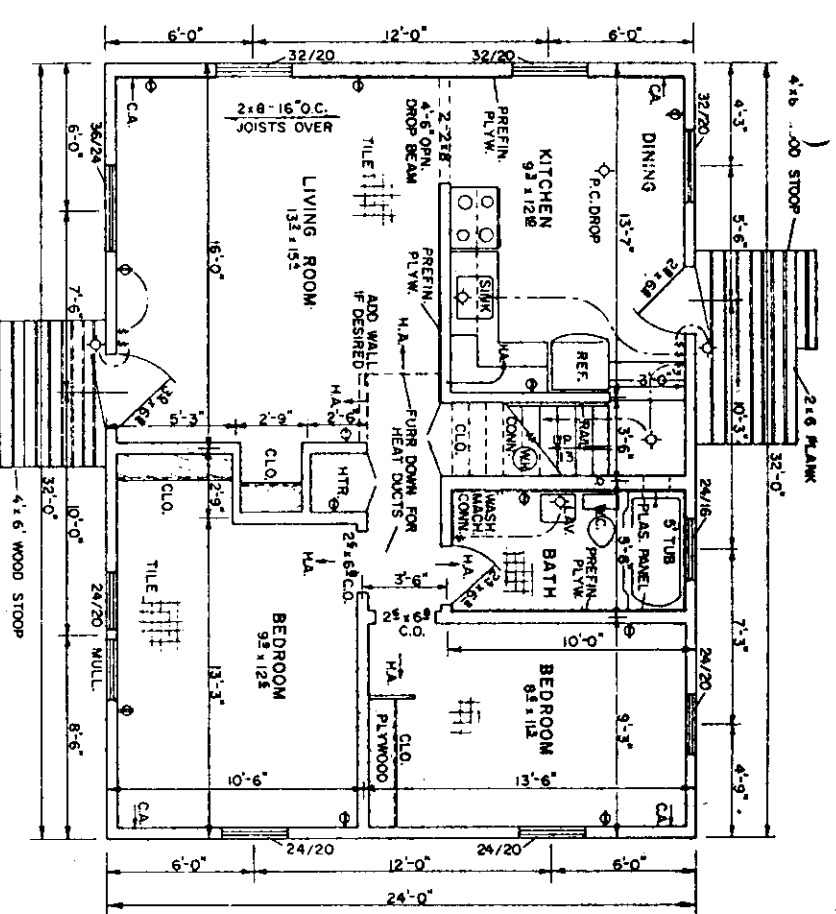
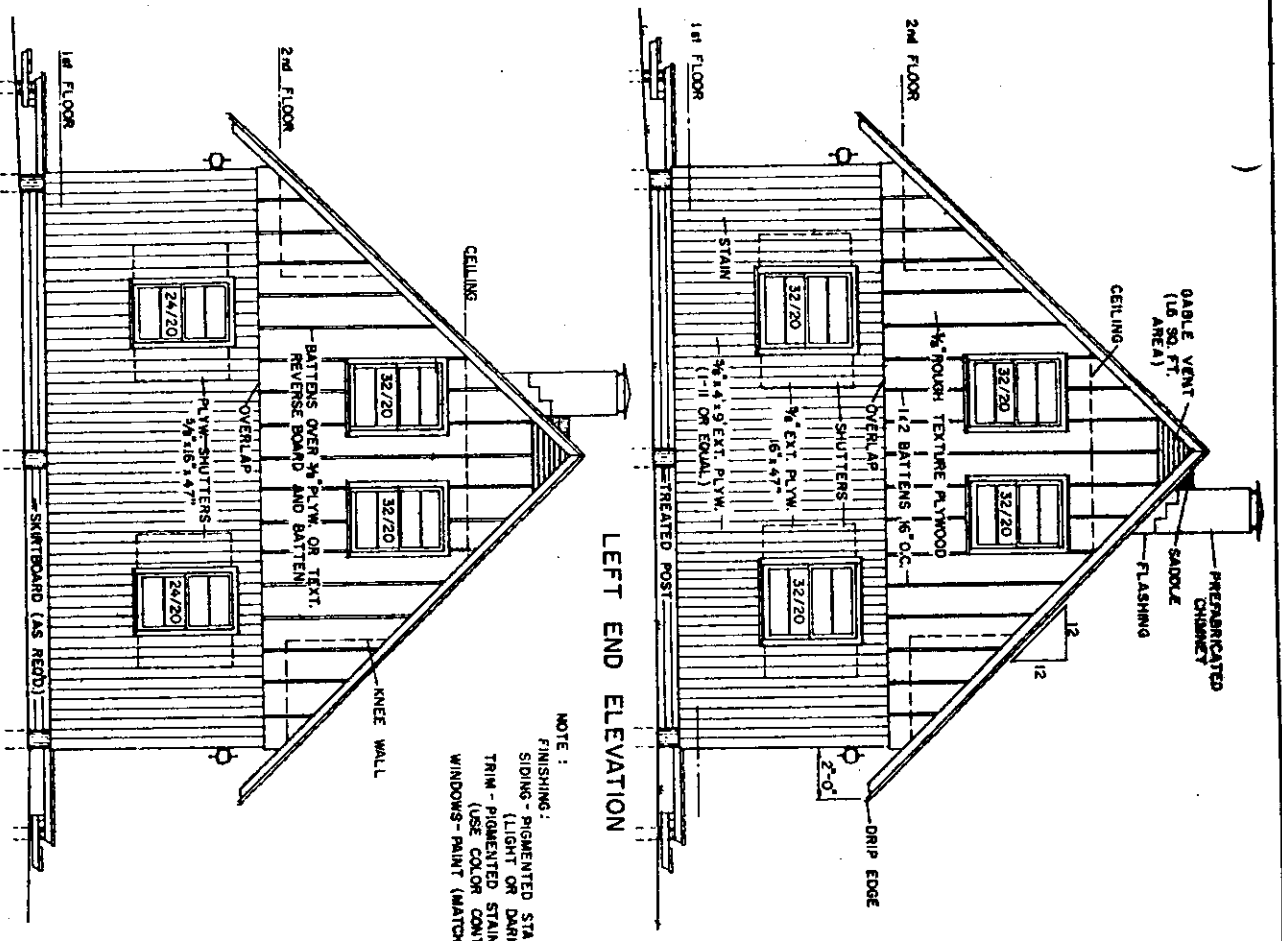

LEFT END ELEVATION

RIGHT END ELEVATION

NOTE:
 FINISHING:
 SIDING - PIGMENTED STAIN
 (LIGHT OR DARK)
 TRIM - PIGMENTED STAIN
 (USE COLOR CONTRAST)
 WINDOWS - PAINT (MATCH TRIM)



SCALE

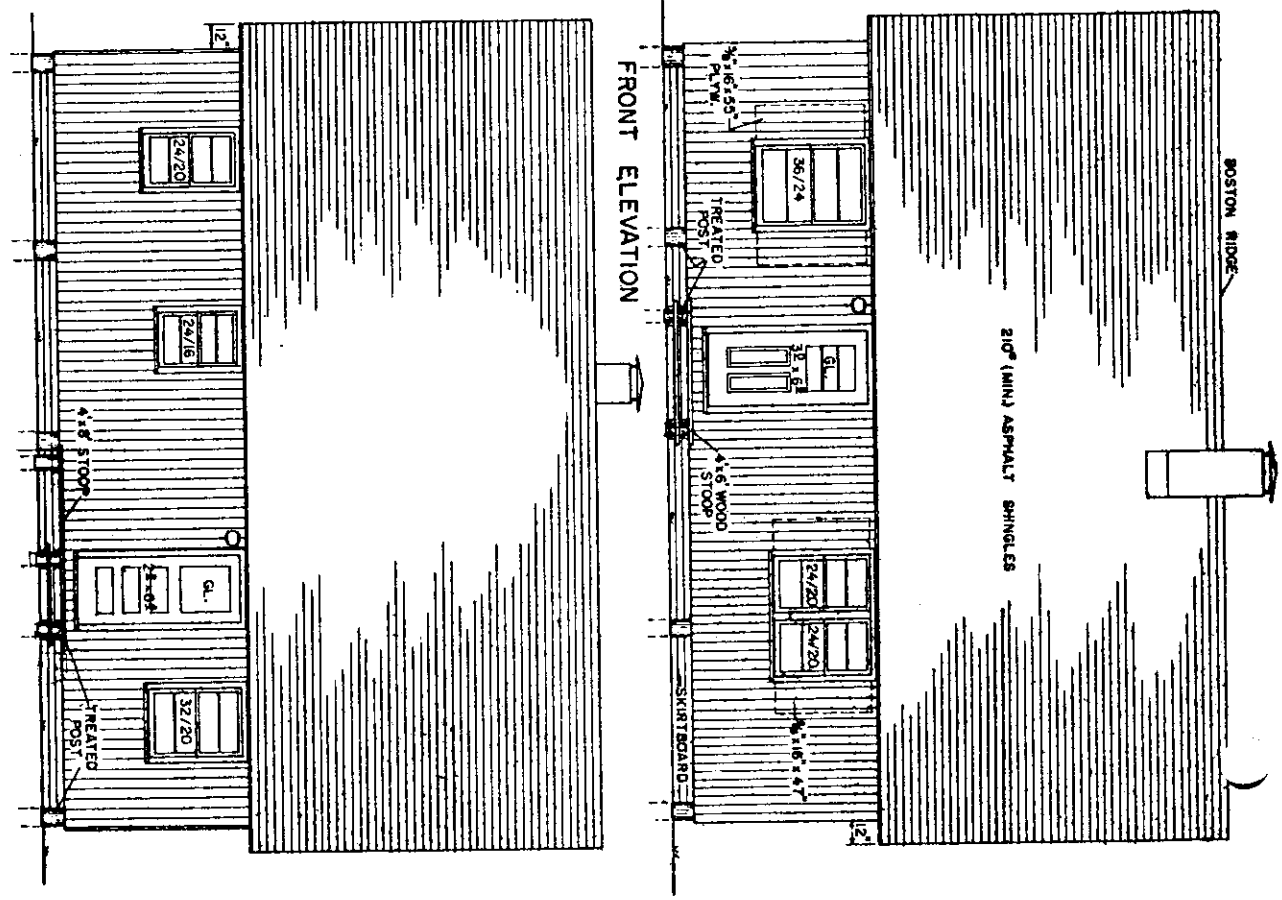

FRONT ELEVATION

REAR ELEVATION

COOPERATIVE EXTENSION WORK IN
 AGRICULTURE AND HOME ECONOMICS

UNITED STATES DEPARTMENT OF AGRICULTURE COOPERATING
 AND
 NATIONAL AGRICULTURAL EXPERIMENT STATION

FOUR BEDROOM HOUSE
 FRAME CONSTRUCTION

USDA 70 7188 SHEET 3 OF 5

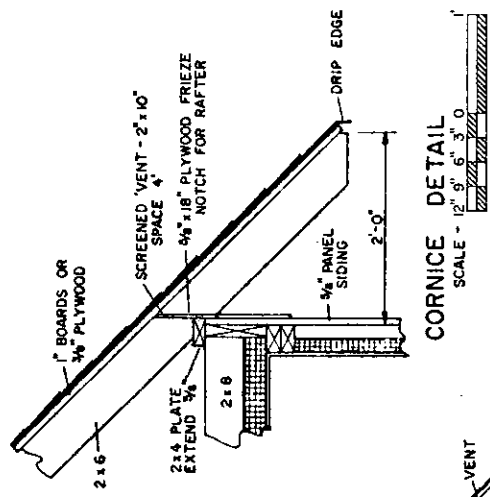
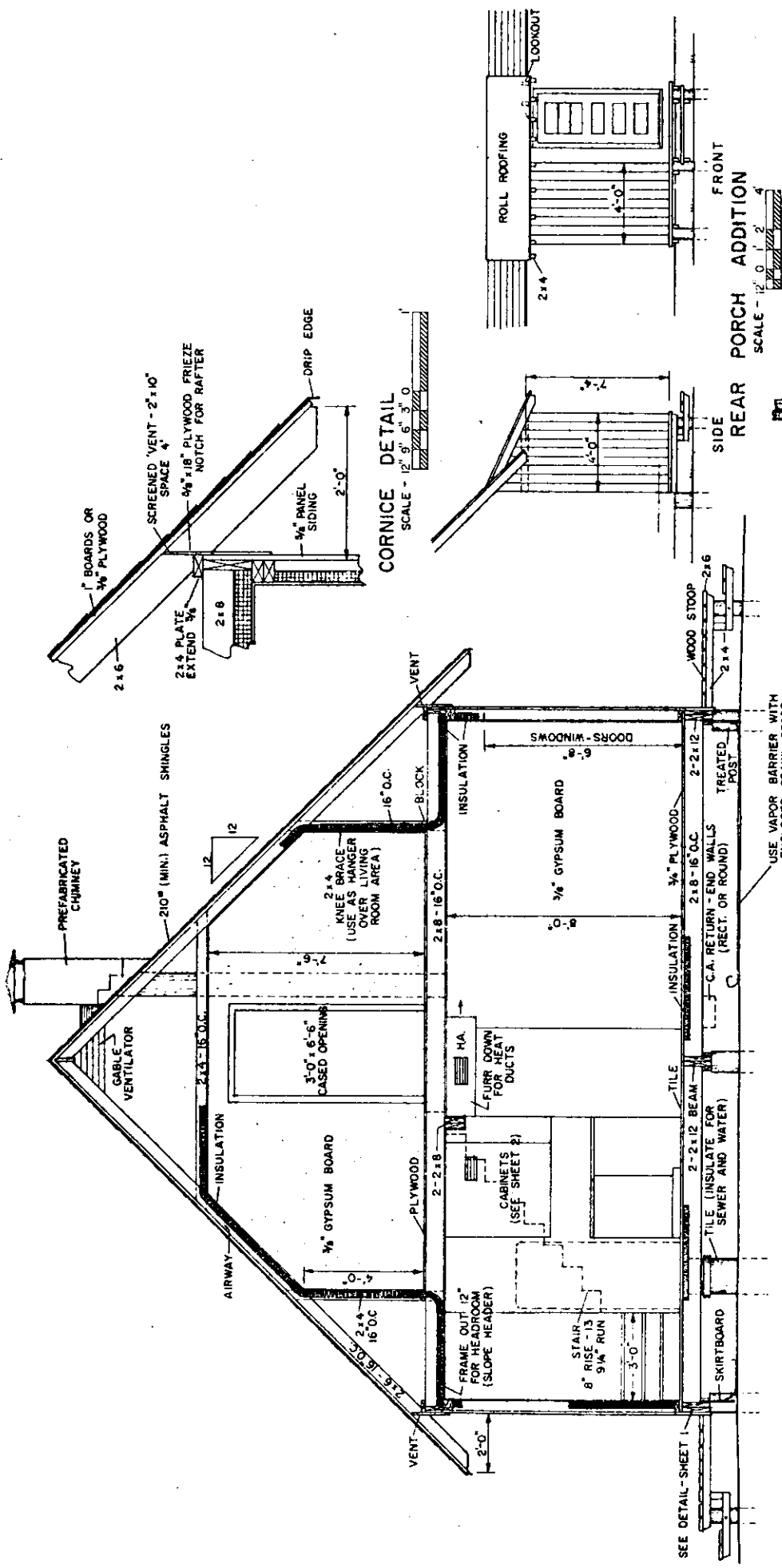

CORNICHE DETAIL
SCALE - 1/2" = 6" 3/4"

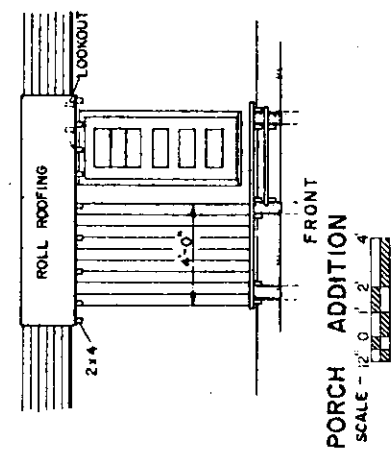

FRONT PORCH ADDITION
SCALE - 1/2" = 6" 3/4"

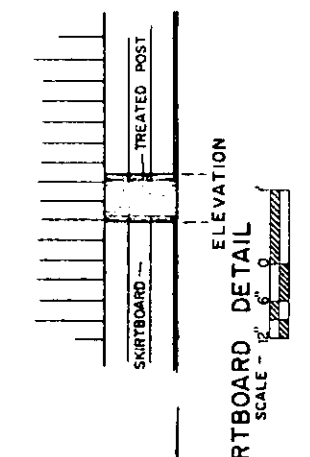

SKIRTBOARD DETAIL
SCALE - 1/2" = 6" 3/4"

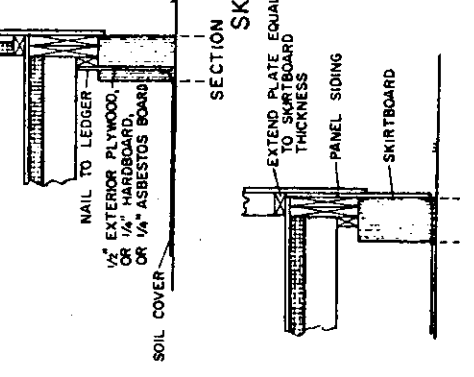

SECTION SKIRTBOARD DETAIL
SCALE - 1/2" = 6" 3/4"

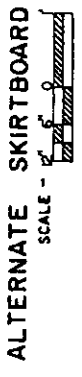

ALTERNATE SKIRTBOARD
SCALE - 1/2" = 6" 3/4"

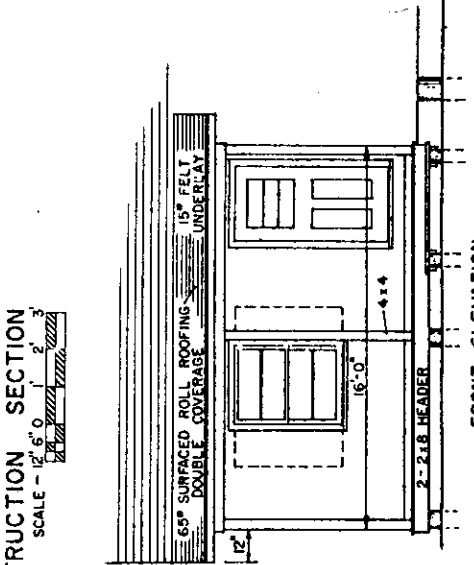

CONSTRUCTION SECTION
SCALE - 1/2" = 6" 3/4"

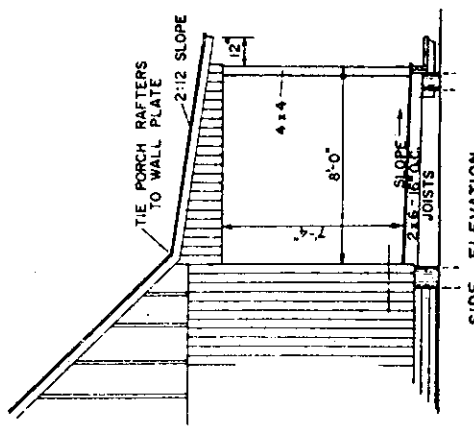

SIDE ELEVATION
SCALE - 1/2" = 6" 3/4"

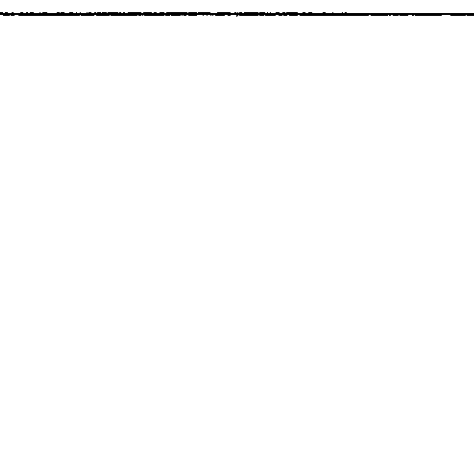

FRONT ELEVATION
SCALE - 1/2" = 6" 3/4"



PORCH ADDITION
SCALE - 1/2" = 6" 3/4"

COOPERATIVE EXTENSION WORK IN
AGRICULTURE AND HOME ECONOMICS

UNITED STATES DEPARTMENT OF AGRICULTURE COOPERATING

AND
FOUR BEDROOM HOUSE
FRAME CONSTRUCTION

USDA '70 J SHEET 4 OF 5

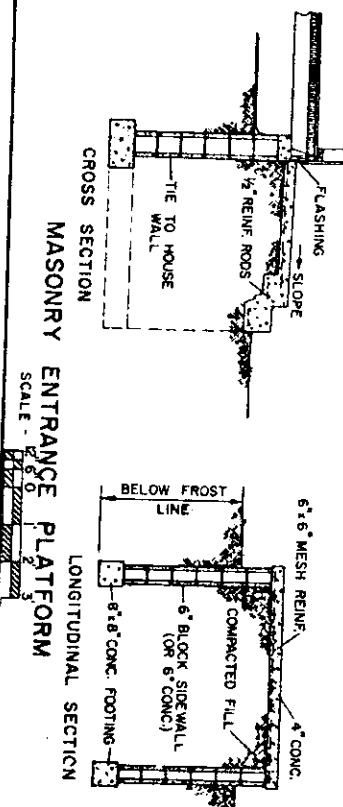
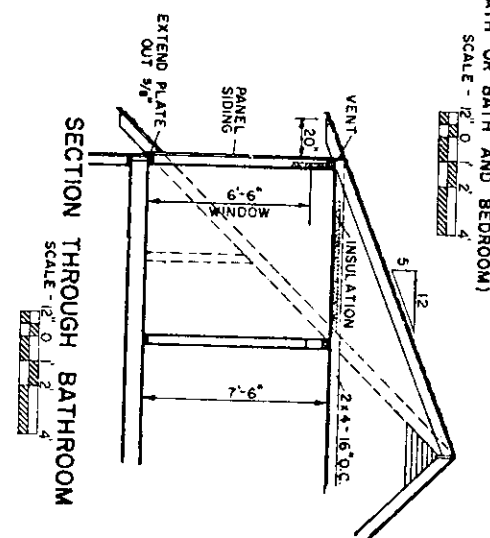
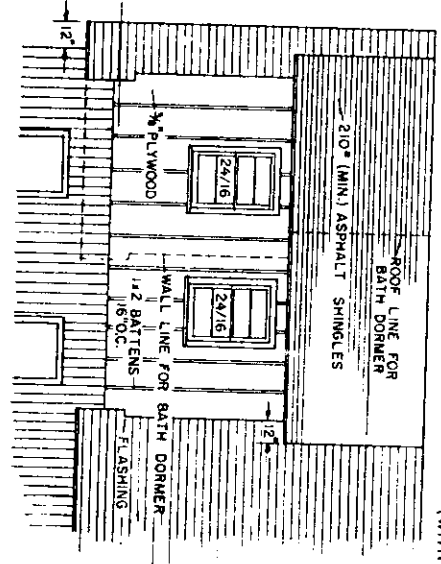
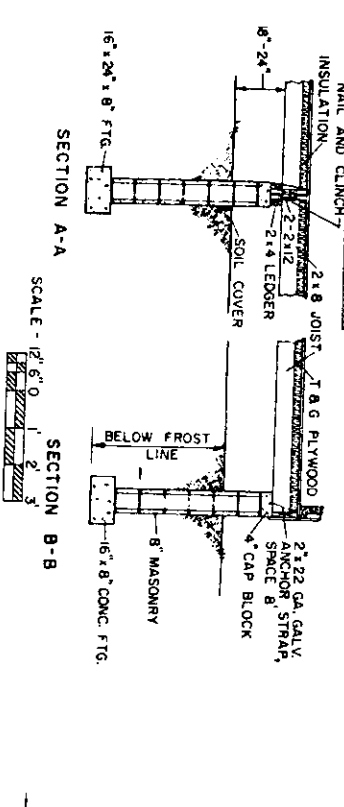
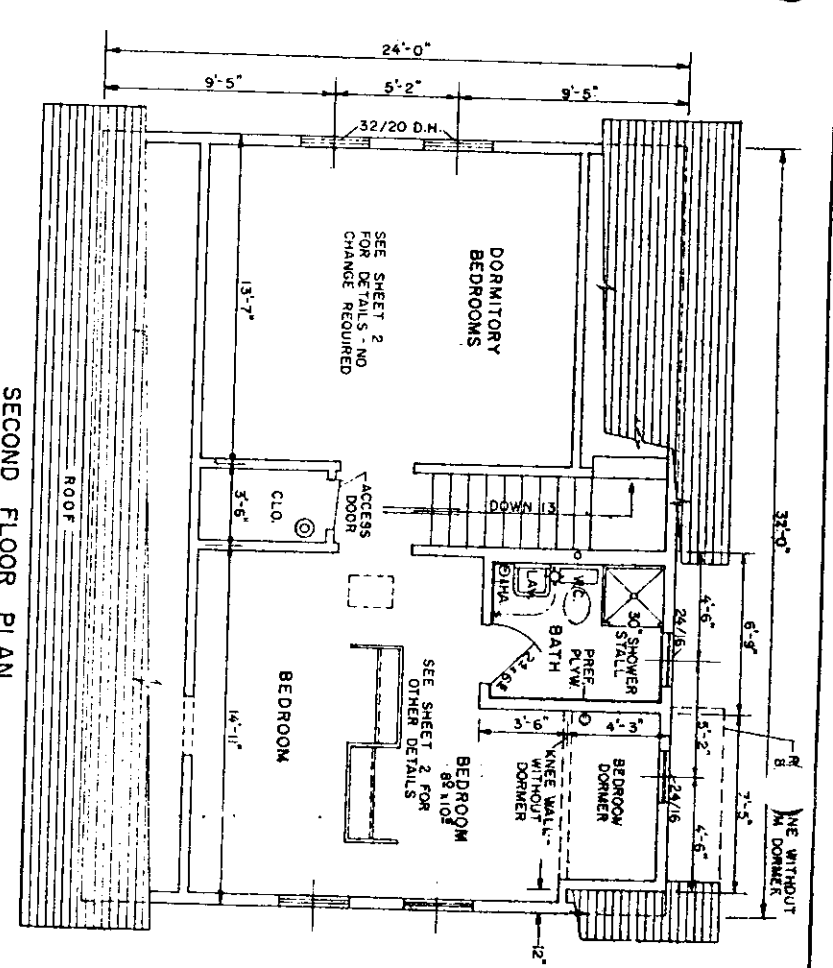
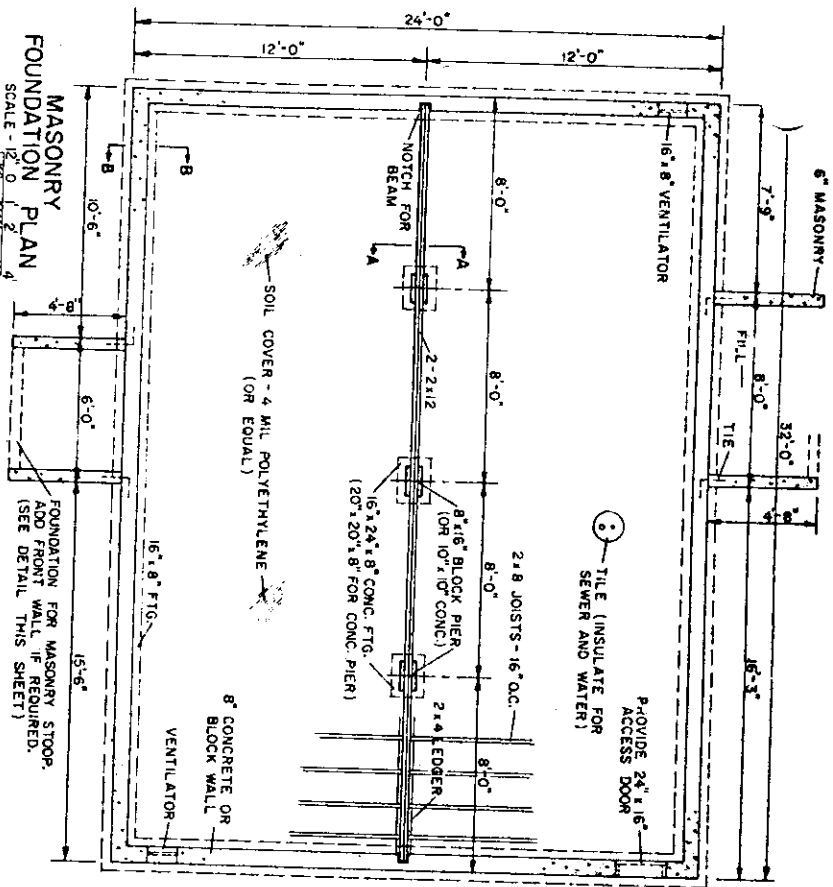

UNITED STATES DEPARTMENT OF AGRICULTURE COOPERATING AND
FOUR BEDROOM HOUSE FRAME CONSTRUCTION
 COOPERATIVE EXTENSION WORK IN AGRICULTURE AND HOME ECONOMICS
 USDA '70 7188 SHEET 5 OF 5