

FLOOR PLAN

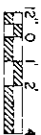

DOOR SCHEDULE		
MARK	SIZE	TYPE
1	3'-0" x 6'-8"	SOLID CORE EXTERIOR
2	2'-8" x 6'-8"	HOLLOW CORE INTERIOR
3	2'-6" x 6'-8"	HOLLOW CORE INTERIOR
4	2'-0" x 6'-8"	BI-FOLD
5	3'-0" x 6'-8"	BI-FOLD
6	6'-0" x 6'-8"	GLASS SLIDING

WINDOW SCHEDULE		
MARK	SIZE	TYPE
A	2'-8" x 6'-0"	COMBINATION Fixed Upper w/ Awning Lower
R	2'-8" x 4'-0"	Double Hung
C	2'-0" x 1'-4"	Awning
D	2'-6" x 6'-8"	Fixed Glass

COOPERATIVE EXTENSION SERVICE  
 AGRICULTURE AND HOME ECONOMICS  
 UNITED STATES DEPARTMENT OF AGRICULTURE COOPERATING  
 AND AGRICULTURE COOPERATING  
**4-BEDROOM RURAL DWELLING**  
 ARK. 69 7184 SHEET 1 OF 3  
 REV. '86

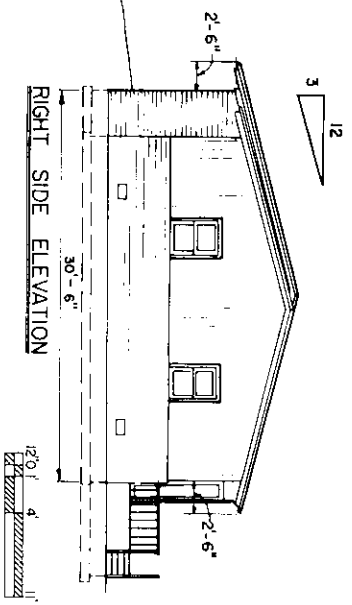

RIGHT SIDE ELEVATION

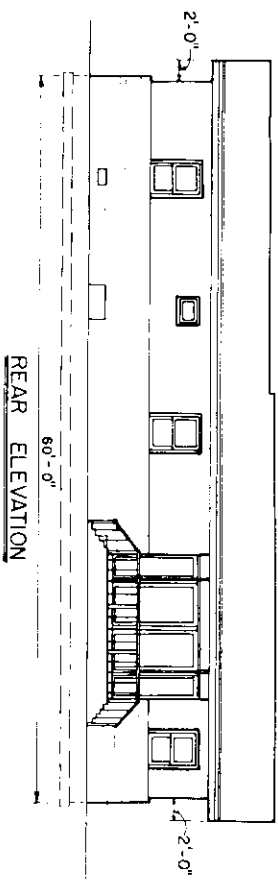

REAR ELEVATION

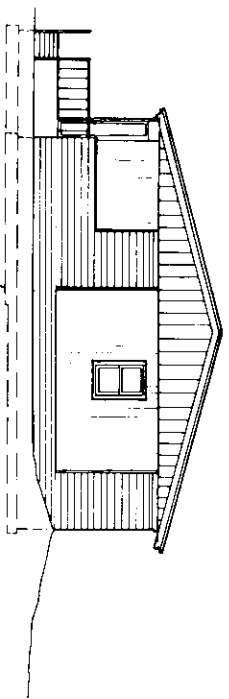

LEFT SIDE ELEVATION

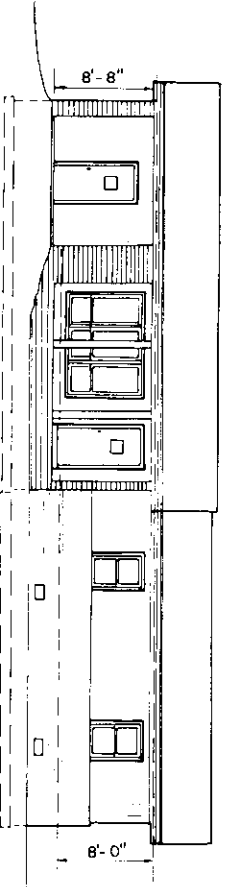

FRONT ELEVATION

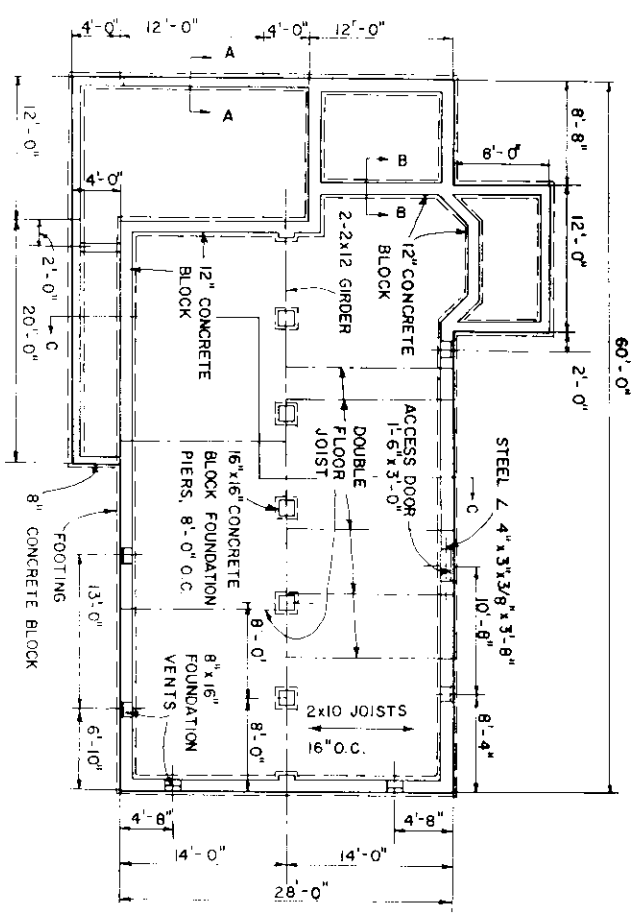

FOUNDATION PLAN

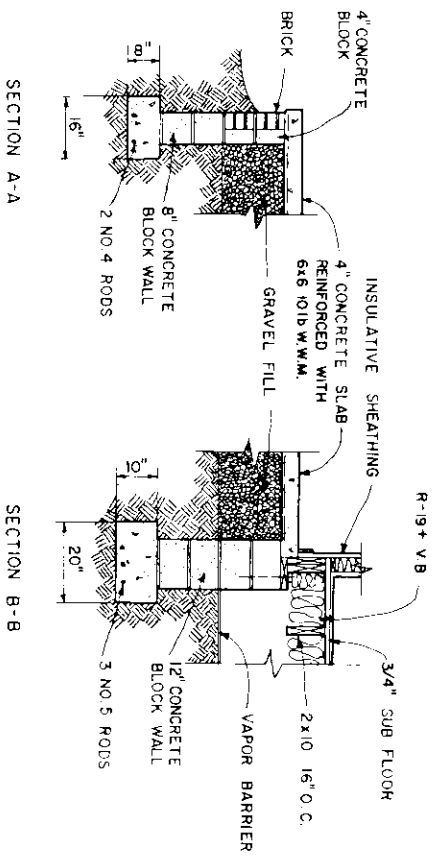

FOUNDATION SECTIONS

COOPERATIVE EXTENSION SERVICE  
 AGRICULTURE AND HOME ECONOMICS  
 UNITED STATES DEPARTMENT OF AGRICULTURE COOPERATING  
 AND NATIONAL AGRICULTURAL MECHANIZATION ADMINISTRATION

4-BEDROOM RURAL DWELLING

ARK 69 7184 SHEET 2 OF 3

REV 86

CONSTRUCTION CHECK LIST

1. CHECK LOCAL BUILDING CODE AND LEAN COMPANY CRITERIA. PURCHASE TRUSSES TO MEET LOCAL SNOW LOAD CRITERIA (2-2x12 R4M DESIGNED FOR 25 1b/ft<sup>2</sup> TOTAL LOAD).
2. ADEQUATELY NAIL AND ANCHOR JOINTS.
3. DOUBLE JOISTS UNDER TUBS AND OTHER HEAVY LOADS.
4. SHEATH CORNERS WITH 1/2" PLYWOOD OR HIGH DENSITY FIBERBOARD OR USE DIAGONAL BRACING.
5. USE EXTERIOR GLUED PLYWOOD WHEREVER IT MAY BE WETTED DURING OR AFTER CONSTRUCTION.
6. PRESSURE TREAT ALL WOOD WITH GROUND CONTACT AND PROVIDE OTHER NEEDED TERMITE CONTROL.
7. R VALUES DEPEND ON LOCAL CLIMATE AND FUEL COSTS.
8. PROVIDE 1 SQ. FT. OF ATTIC VENT OPENINGS FOR EACH 150 SQ. FT. OF CEILING.
9. WEATHERIZE ALL OPENINGS AND JOINTS.

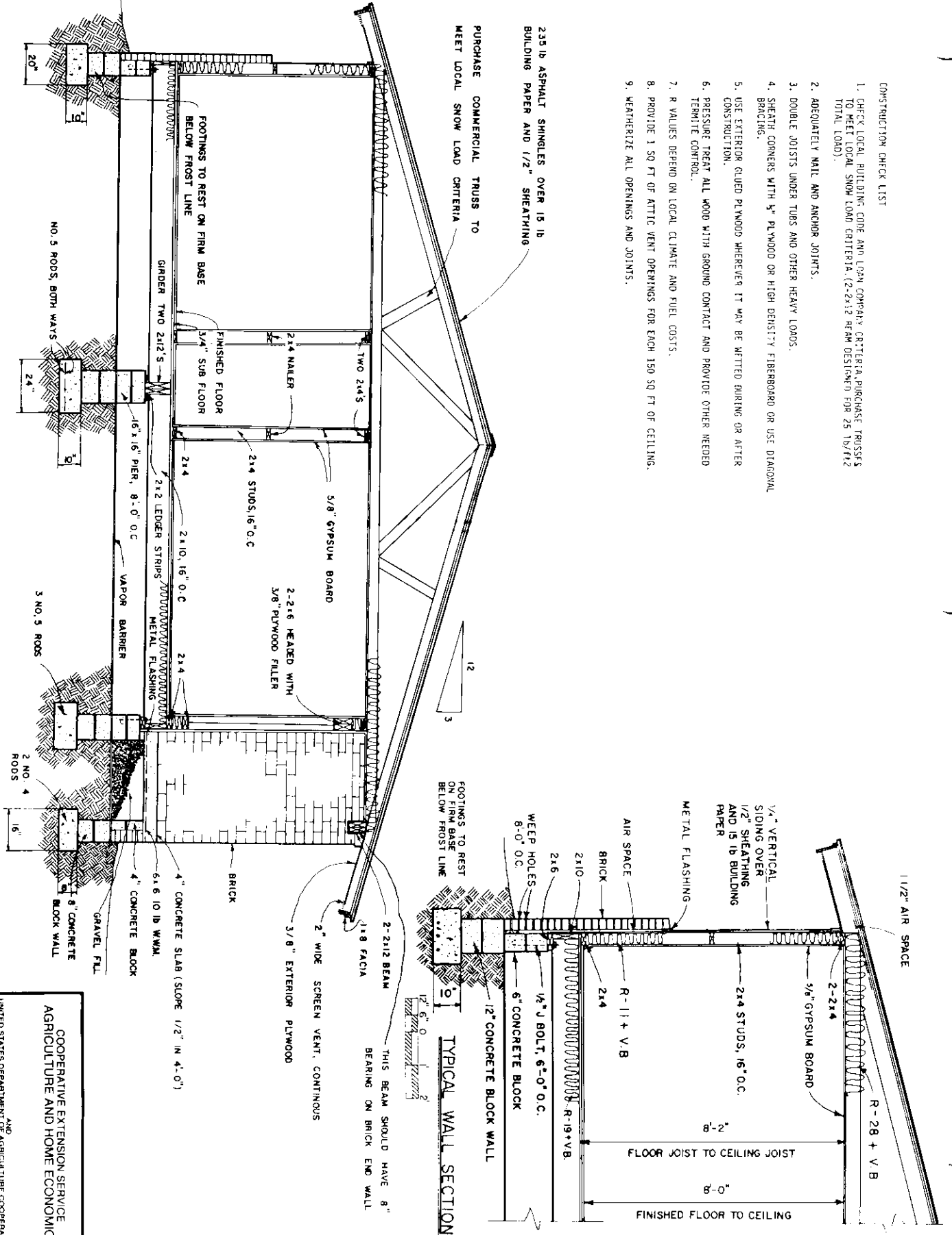

SECTION C-C

TYPICAL WALL SECTION

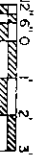

COOPERATIVE EXTENSION SERVICE  
AGRICULTURE AND HOME ECONOMICS

4-BEDROOM RURAL DWELLING

ARK.	'69	7184	SHEET 3 OF 3
REV.	'86		