

SLAB PLAN.
Scale: 1/4" = 1'-0"

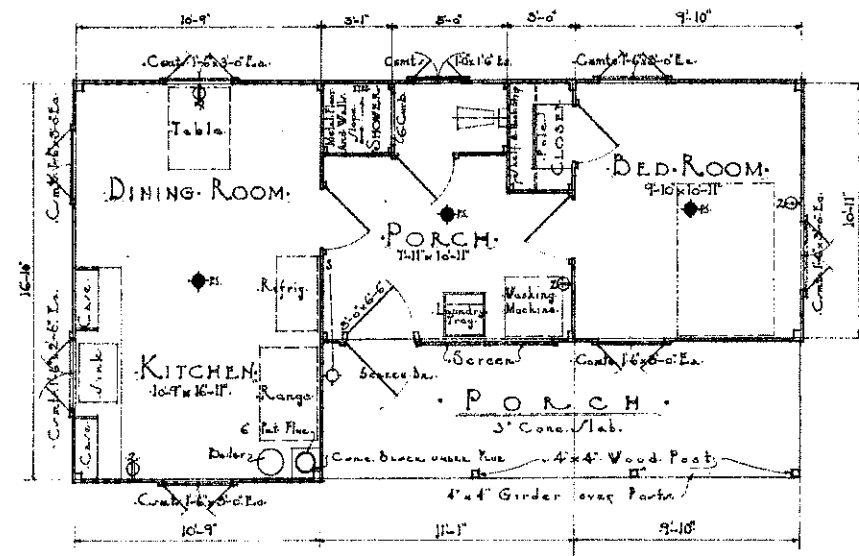

FLOOR PLAN.
Scale: 1/4" = 1'-0"

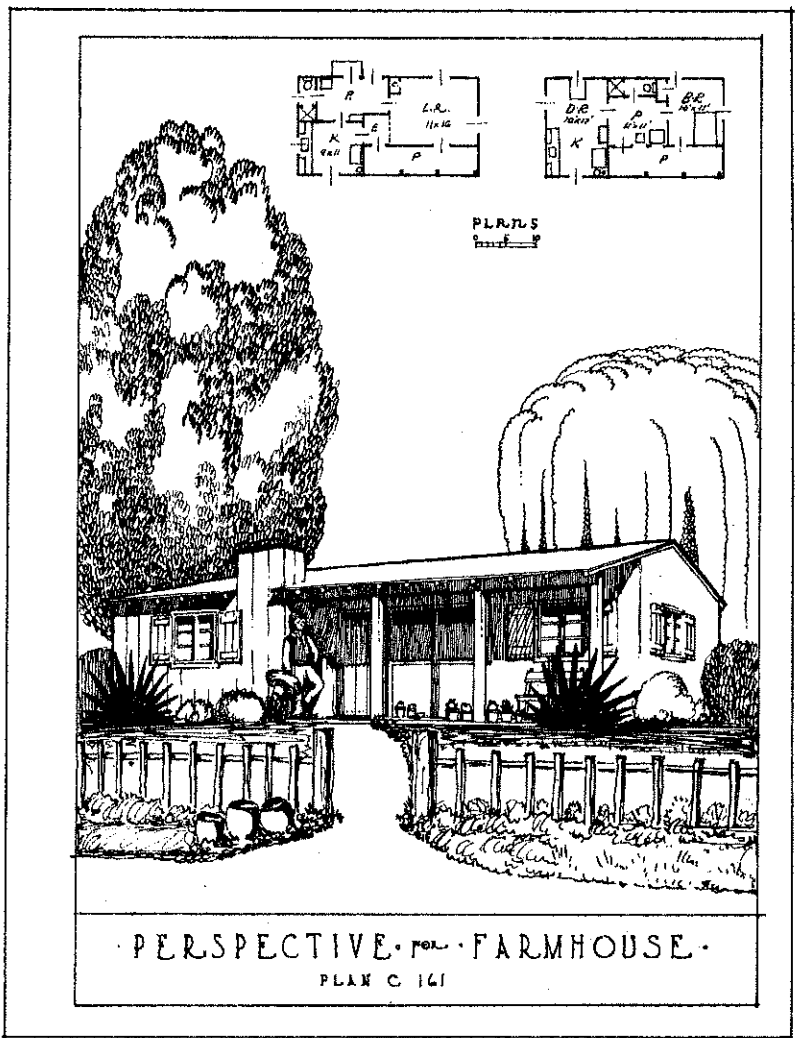

PERSPECTIVE FOR FARMHOUSE.
PLAN C 161

ELECTRICAL.

- PS Pull Switch
- Wall Bracket
- Double Outlet
- Wall Switch

PLAN PREPARED UNDER THE RURAL HOUSING PROJECT - BUREAU OF HOME ECONOMICS AND AGRICULTURAL ENGINEERING - U.S. DEPARTMENT OF AGRICULTURE AND CIVIL WORKS ADMINISTRATION COOPERATING.

COOPERATIVE EXTENSION WORK IN AGRICULTURE AND HOME ECONOMICS
STATE OF NORTH DAKOTA
NORTH DAKOTA AGRICULTURAL COLLEGE
AND
U.S. DEPT. OF AGRICULTURE COOPERATING.
EXT. AGR'L. ENGINEER- FARGO, N.DAK.

FARM HOUSE

CALIF. '34 EX. 6505 SHEET 1 OF 5

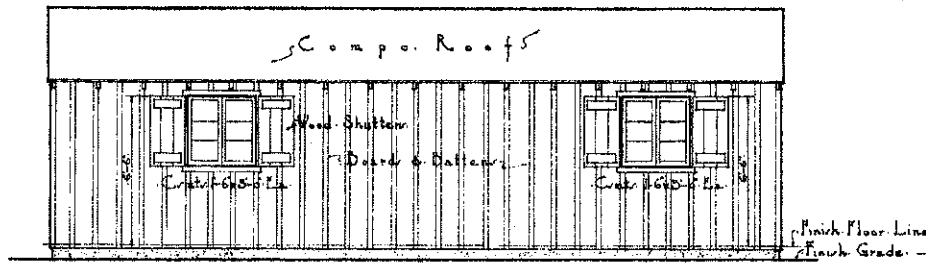

REAR ELEVATION
Scale 1/4"=1'-0"

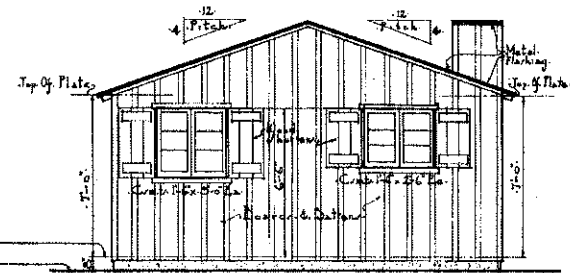

SIDE ELEVATION
Scale 1/4"=1'-0"

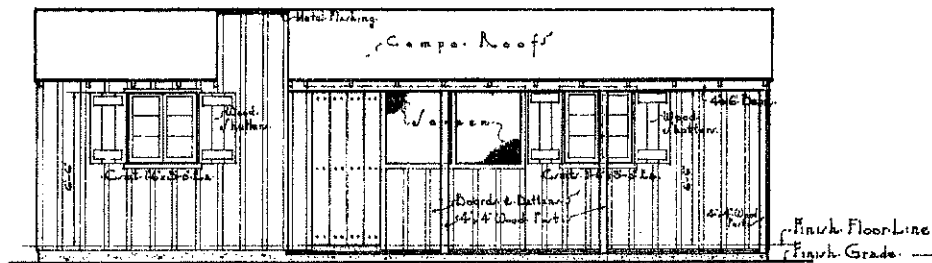

FRONT ELEVATION
Scale 1/4"=1'-0"

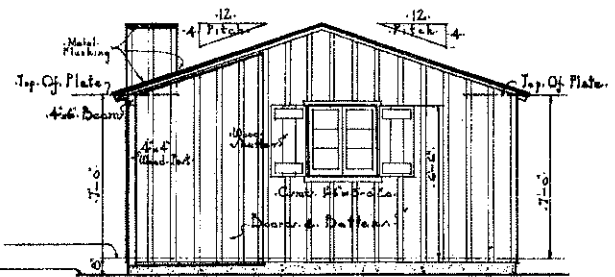

SIDE ELEVATION
Scale 1/4"=1'-0"

PLAN PREPARED UNDER THE RURAL HOUSING PROJECT - BUREAUS OF HOME ECONOMICS AND AGRICULTURAL ENGINEERING - U.S. DEPARTMENT OF AGRICULTURE AND CIVIL WORKS ADMINISTRATION COOPERATING.

COOPERATIVE EXTENSION WORK IN AGRICULTURE AND HOME ECONOMICS
STATE OF NORTH DAKOTA
NORTH DAKOTA AGRICULTURAL COLLEGE
AND
U.S. DEPT. OF AGRICULTURE COOPERATING.
EXT. AGR'L. ENGINEER - FARGO, N. DAK.

FARM HOUSE

CALIF. 134 EX. 6505 SHEET 2 OF 5

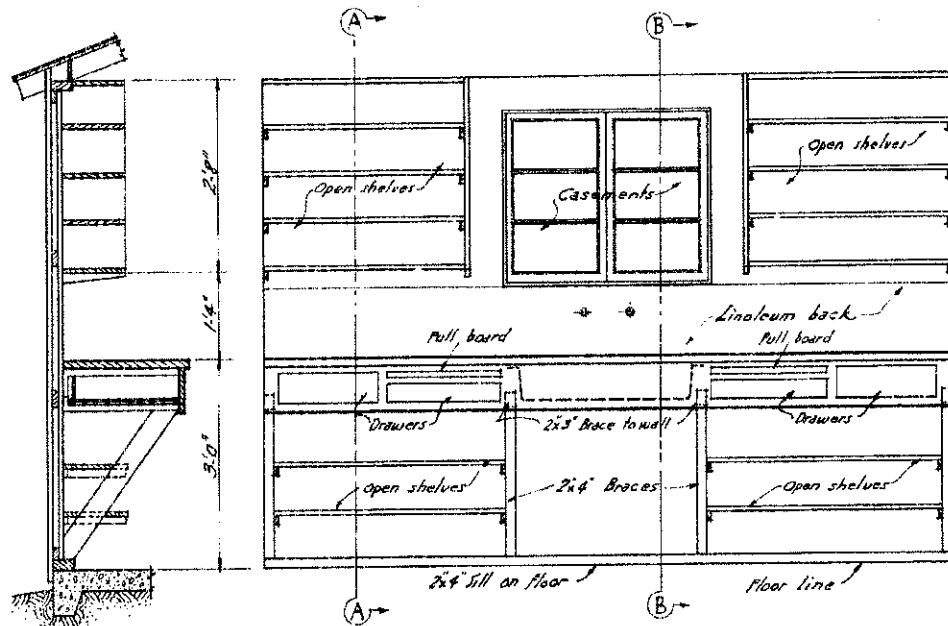

SECTION A-A

ELEVATION OF SINK CASE
Scale $\frac{3}{4}'' = 1'-0''$

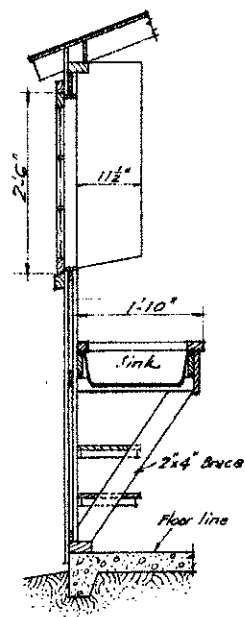

SECTION B-B

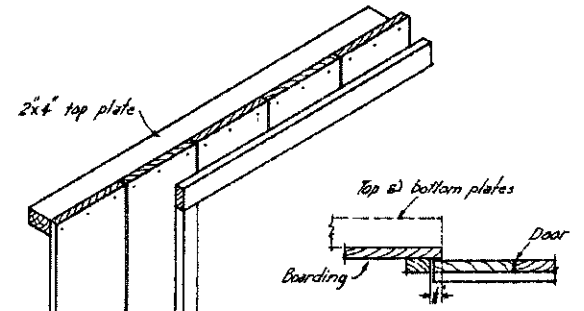

PLAN OF JAMB

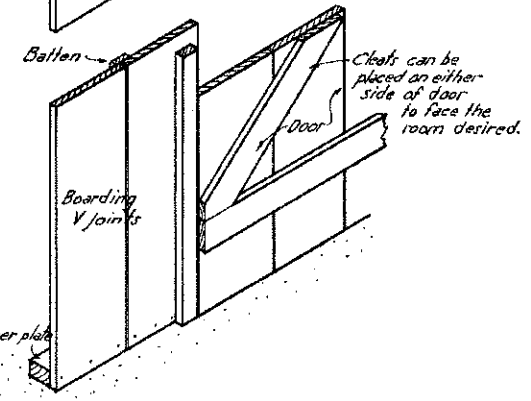

ISOMETRIC OF INTERIOR PARTITION
Scale $1\frac{1}{2}'' = 1'-0''$

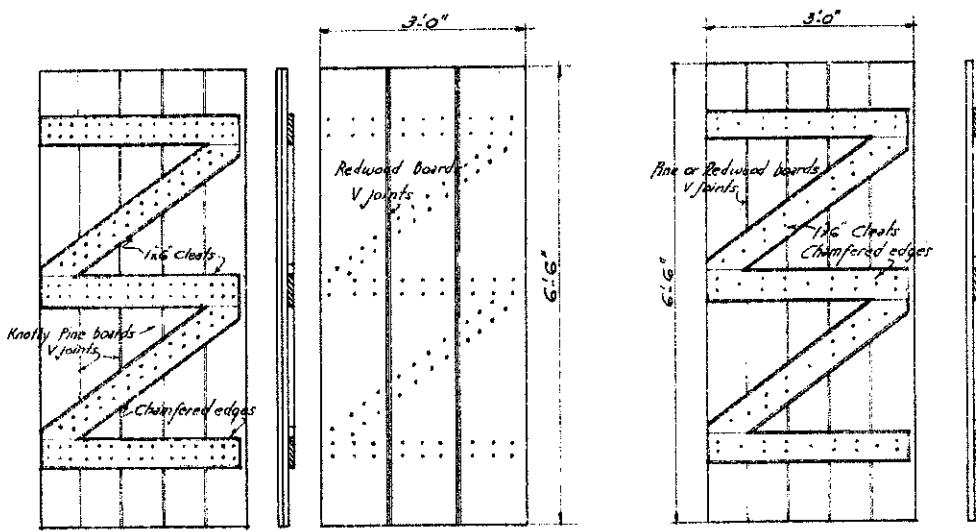

INTERIOR SECT. EXTERIOR
MAIN ENTRANCE DOOR

INTERIOR DOOR

Scale $\frac{1}{4}'' = 1'-0''$

TYPICAL INTERIOR DETAILS

PLAN PREPARED UNDER THE RURAL HOUSING PROJECT - BUREAU OF HOME ECONOMICS AND AGRICULTURAL ENGINEERING - U.S. DEPARTMENT OF AGRICULTURE AND CIVIL WORKS ADMINISTRATION COOPERATING.

COOPERATIVE EXTENSION WORK IN AGRICULTURE AND HOME ECONOMICS
STATE OF NORTH DAKOTA
NORTH DAKOTA AGRICULTURAL COLLEGE
AND
U.S. DEPT. OF AGRICULTURE COOPERATING.
EXT. AGR'L. ENGINEER - FARGO, N. DAK.

TYPICAL DETAILS

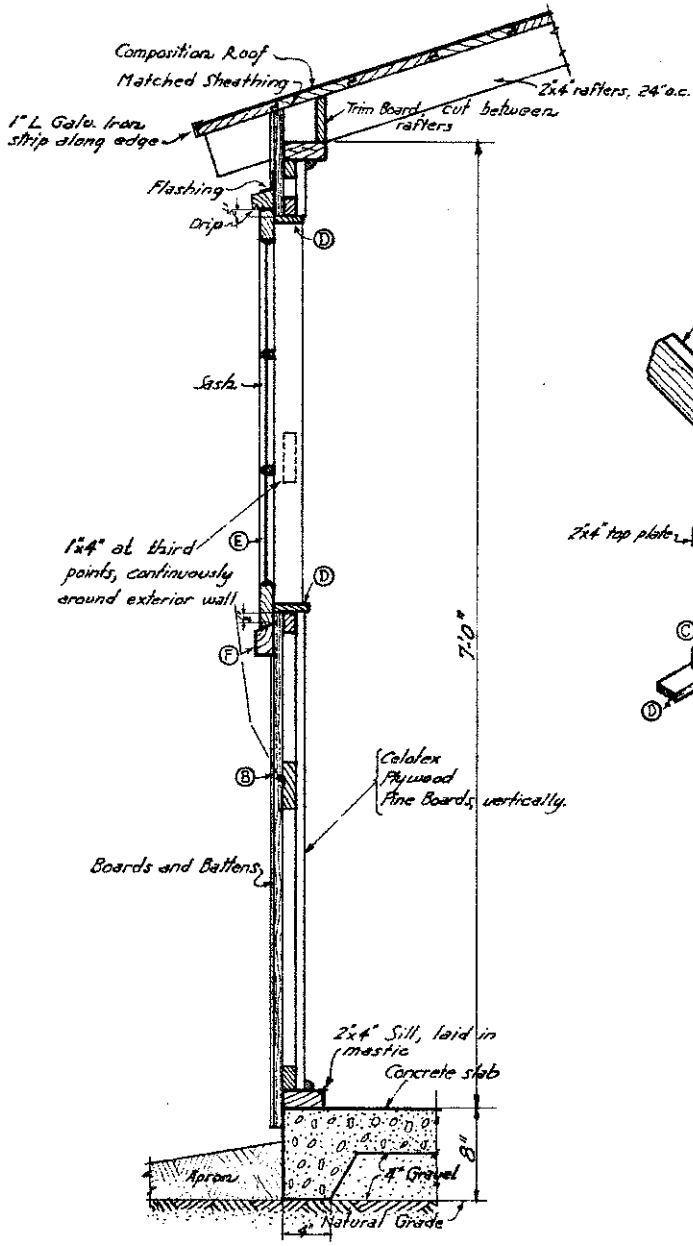

WALL SECTION
Scale 1/2" = 1'-0"

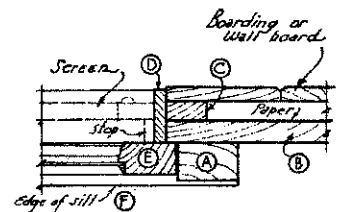
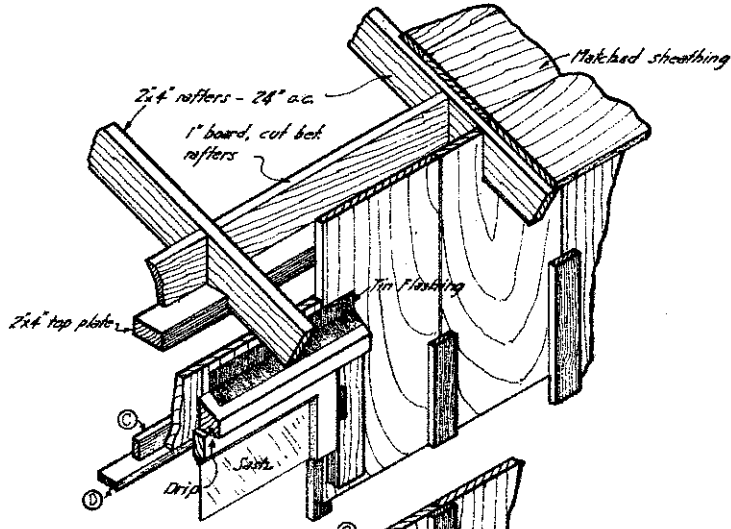

PLAN THRU JAMB
Scale 3" = 1'-0"

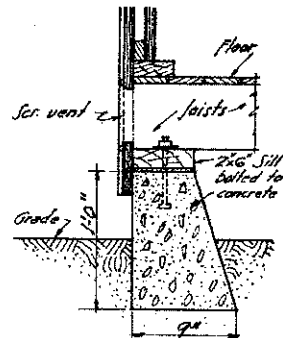
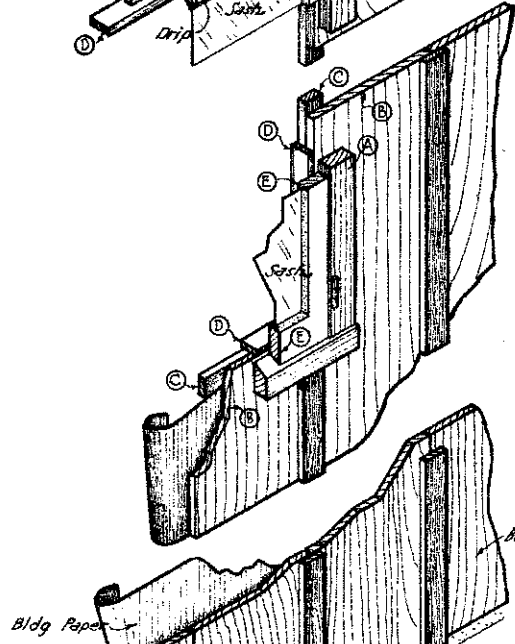

ALTERNATE DETAIL FOR JOIST CONSTRUCTION

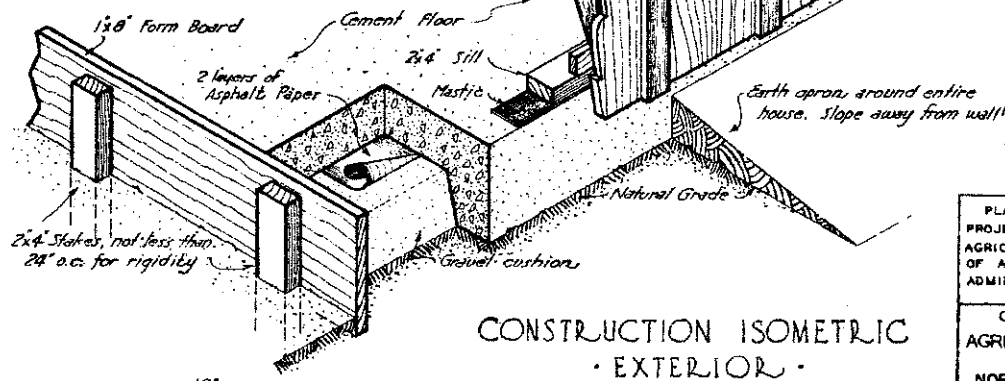

CONSTRUCTION ISOMETRIC - EXTERIOR
Scale 1/2" = 1'-0"

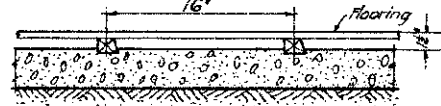

WITH SLEEPERS @ FLOORING

PLAN PREPARED UNDER THE RURAL HOUSING PROJECT - BUREAUS OF HOME ECONOMICS AND AGRICULTURAL ENGINEERING - U.S. DEPARTMENT OF AGRICULTURE AND CIVIL WORKS ADMINISTRATION COOPERATING.

COOPERATIVE EXTENSION WORK IN AGRICULTURE AND HOME ECONOMICS STATE OF NORTH DAKOTA NORTH DAKOTA AGRICULTURAL COLLEGE AND U.S. DEPT. OF AGRICULTURE COOPERATING. EXT. AGR'L. ENGINEER - FARGO, N. DAK.

TYPICAL DETAILS

CALIF. '34 EX 6504-05 SHEET 4 OF 5

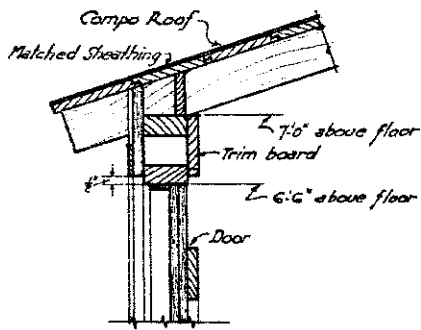

CORNICE SECTION AT DOOR
Scale 1/2" = 1'-0"

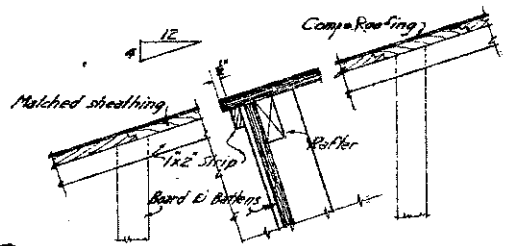

GABLE TRIM
Scale 1/2" = 1'-0"

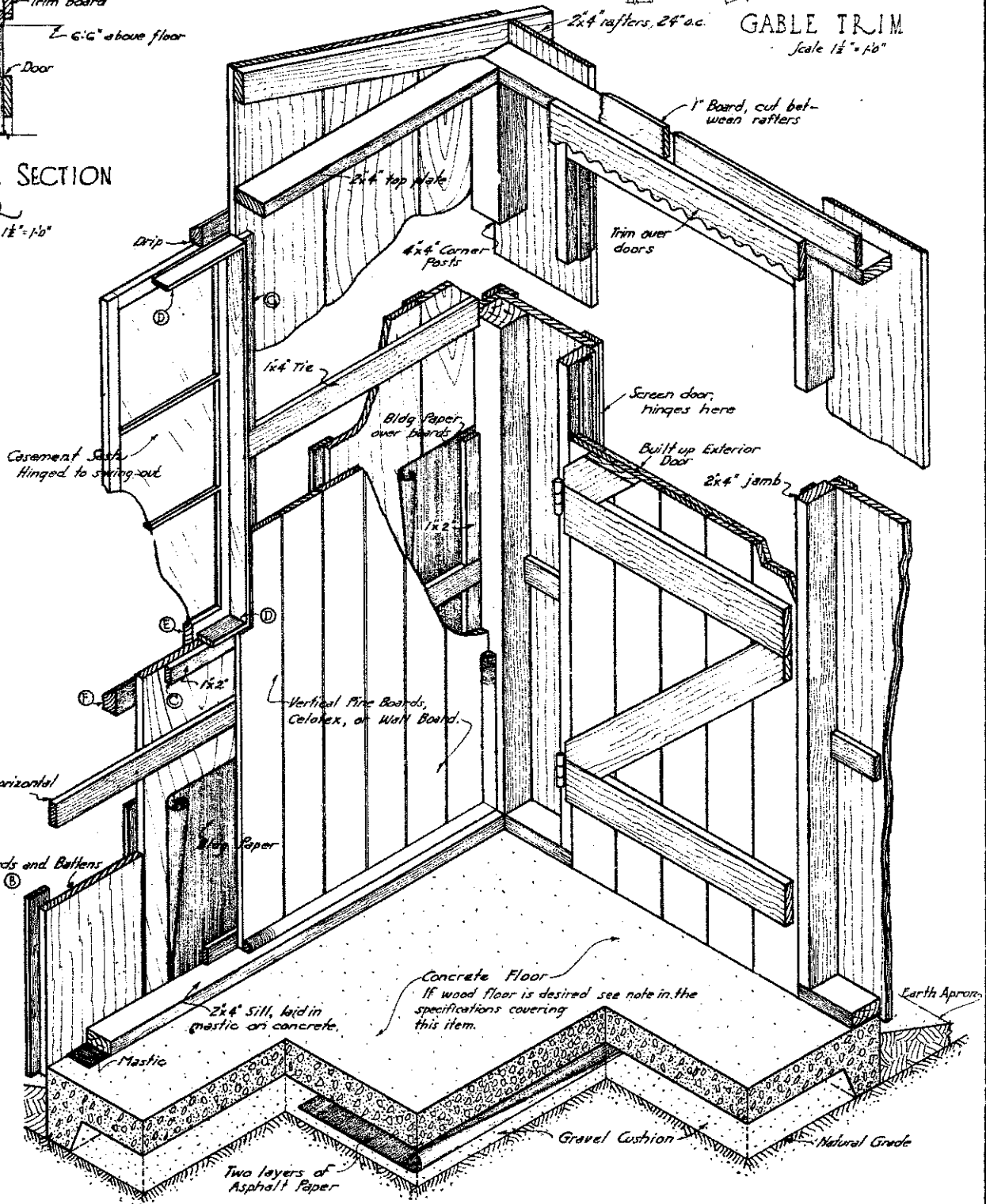

CONSTRUCTION ISOMETRIC INTERIOR
Scale 1/2" = 1'-0"

PLAN PREPARED UNDER THE RURAL HOUSING PROJECT - BUREAU OF HOME ECONOMICS AND AGRICULTURAL ENGINEERING - U.S. DEPARTMENT OF AGRICULTURE AND CIVIL WORKS ADMINISTRATION COOPERATING.

COOPERATIVE EXTENSION WORK IN AGRICULTURE AND HOME ECONOMICS
STATE OF NORTH DAKOTA
NORTH DAKOTA AGRICULTURAL COLLEGE
AND
U.S. DEPT. OF AGRICULTURE COOPERATING.
EXT. AGRICULT. ENGINEER FARGO, N.D.
TYPICAL DETAILS
CALIF. '34 EX. 6504-05 SHEET 5 OF 5