

STRAP STEEL CUTTING DIAGRAM

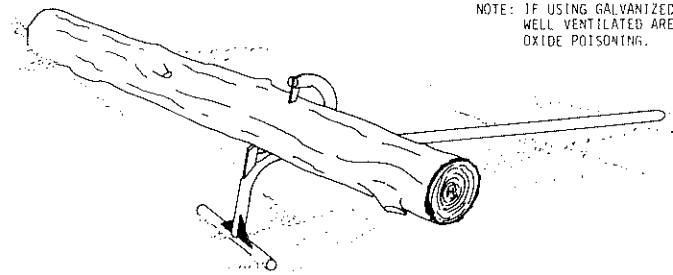

NOTE: IF USING GALVANIZED PIPE, WELD IN WELL VENTILATED AREA TO AVOID ZINC OXIDE POISONING.

PERSPECTIVE NO SCALE

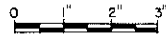
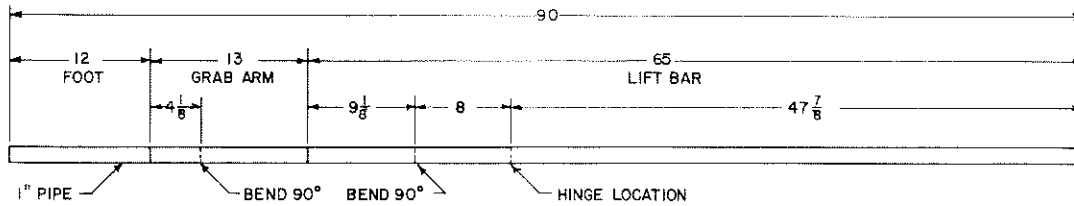

BLACK IRON PIPE CUTTING DIAGRAM

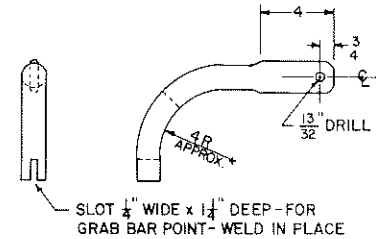
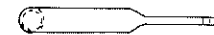

GRAB BAR DETAILS

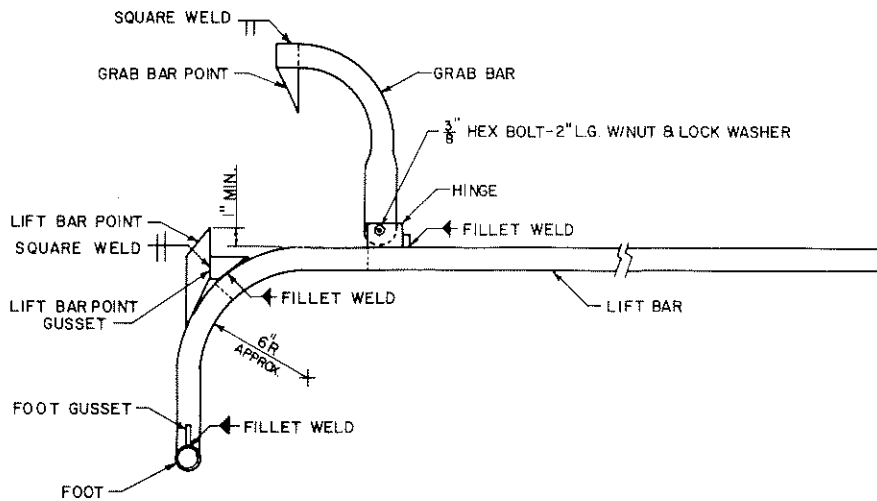

ASSEMBLY DRAWINGS

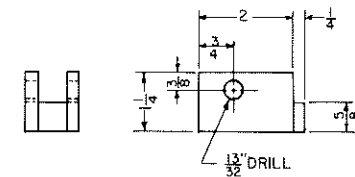
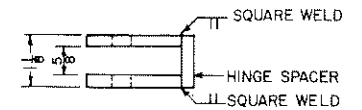
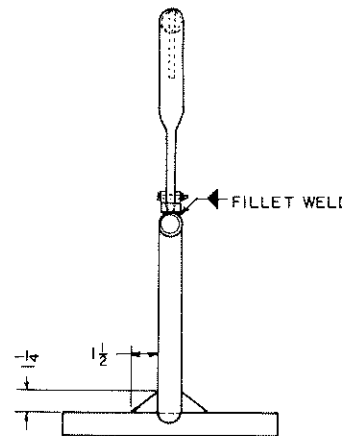
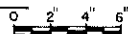

HINGE DETAILS



COOPERATIVE EXTENSION SERVICE  
AGRICULTURE AND HOME ECONOMICS

AND  
UNITED STATES DEPARTMENT OF AGRICULTURE COOPERATING

12" LOG LIFTER

W VA '86 6379 SHEET 1 OF 1