

CONSTRUCTION DETAILS

MENTION OF A TRADE NAME DOES NOT CONSTITUTE A GUARANTEE OR WARRANTY OF THE PRODUCT BY THE U.S. DEPARTMENT OF AGRICULTURE OR AN ENDORSEMENT BY THE DEPARTMENT OVER OTHER PRODUCTS NOT MENTIONED

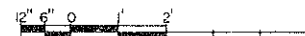

COOPERATIVE EXTENSION WORK IN AGRICULTURE AND HOME ECONOMICS		
AND UNITED STATES DEPARTMENT OF AGRICULTURE COOPERATING		
OUTDOOR GARDEN STORAGE		
APA '77	6284	SHEET 1 OF 3

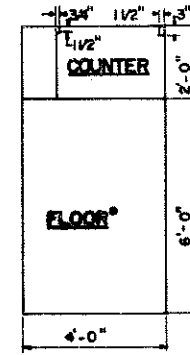
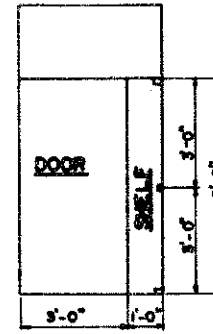
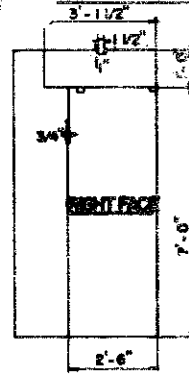
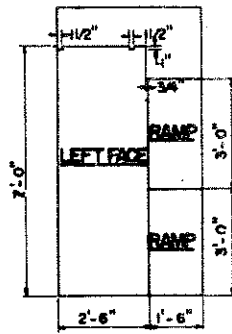
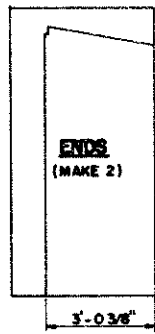
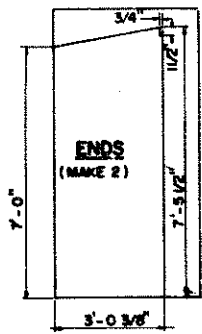

* 5/8" PLYWOOD

NOTE: ALL PIECES ARE TO BE 5/8" PLYWOOD UNLESS OTHERWISE NOTED.

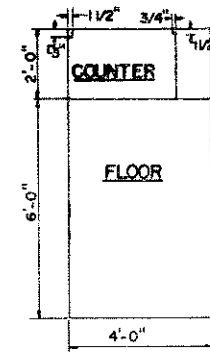
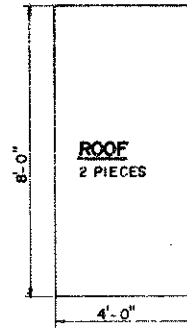
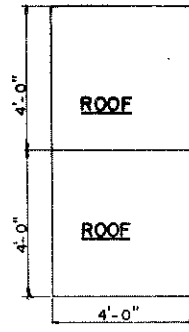
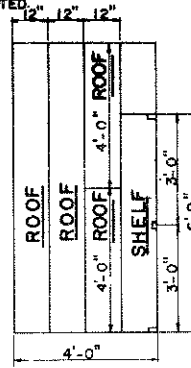
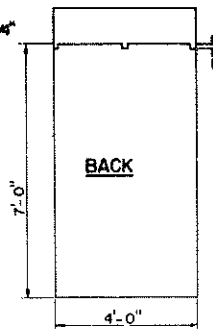
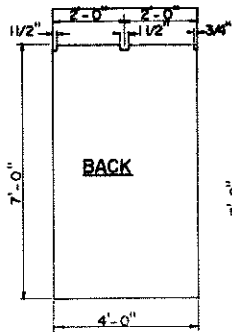

* 5/8" PLYWOOD

APA EXTERIOR PLYWOOD RECOMMENDED FOR CONSTRUCTION.

PLYWOOD CUTTING DETAILS

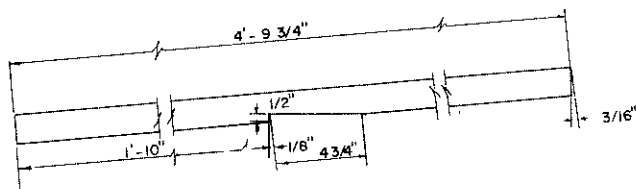
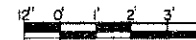

RAFTER DETAIL
(NOT TO SCALE)

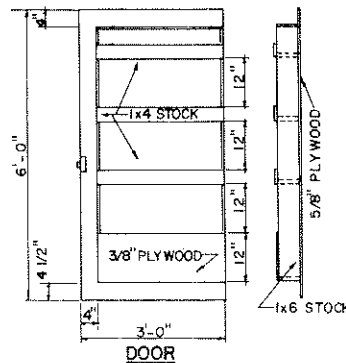

DOOR

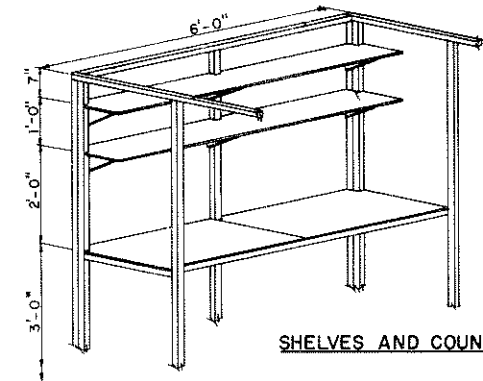

SHELVES AND COUNTER

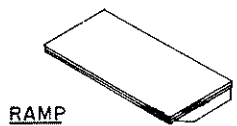

RAMP

ISOMETRIC PROJECTIONS



COOPERATIVE EXTENSION WORK IN AGRICULTURE AND HOME ECONOMICS		
AND UNITED STATES DEPARTMENT OF AGRICULTURE COOPERATING		
OUTDOOR GARDEN STORAGE		
APA '77	6284	SHEET 2 OF 3

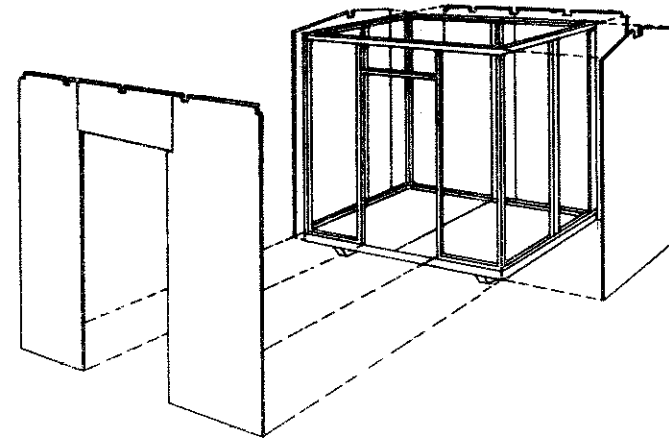
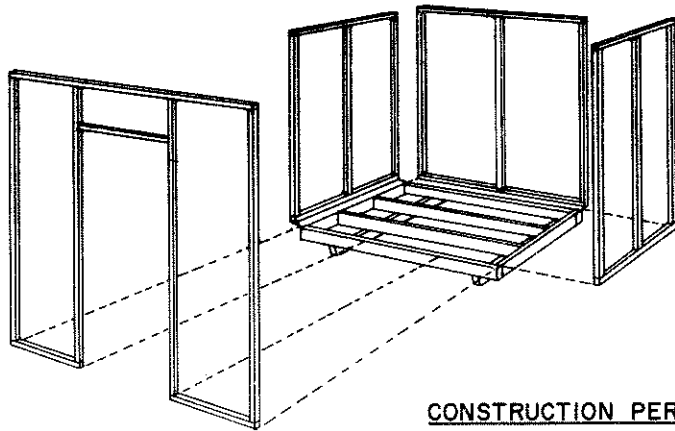

CONSTRUCTION PERSPECTIVES
(NOT TO ANY SCALE)

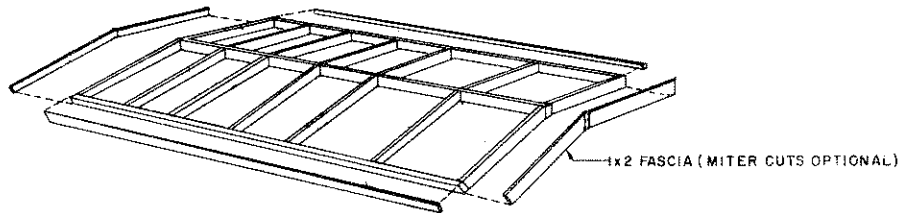

RECOMMENDED PLYWOOD: 303 ® TEXTURED PLYWOOD SIDING AND A-C EXTERIOR APA ® G.T.P.¹

MATERIALS LIST	
QUANTITY	DESCRIPTION
4 PANELS	3/8" x 4'-0" x 8'-0" A-C PLYWOOD FOR ROOF SHEATHING
2 PANELS	3/4" x 4'-0" x 8'-0" A-C PLYWOOD FOR FLOOR AND COUNTER
9 PANELS	5/8" TEXTURED PLYWOOD SIDING FOR DOOR, WALLS, SIDING, AND RAMP.
4 PIECES	2x4 LUMBER - 8 FOOT LONG FOR FLOOR FRAMING
3 PIECES	2x4 LUMBER - 6 FOOT LONG FOR FLOOR FRAMING
184 LIN. FT.	2x2 LUMBER FOR WALL STUDS, COUNTER FRAMING, TOP AND BOTTOM PLATES ²
3 PIECES	2x2 LUMBER - 12 FOOT LONG FOR ROOF FRAMING
7 PIECES	2x2 LUMBER - 10 FOOT LONG FOR ROOF RAFTERS
2 PIECES	4x4 LUMBER - 8 FOOT LONG FOR SKIDS (IF TWO 6-FOOT LENGTHS ARE AVAILABLE, USE THEM)
152 LIN. FT.	1x2 LUMBER FOR FASCIAS AND BATTENS
8 LIN. FT.	1x4 LUMBER FOR SHELF FRONTS
5 PIECES	1x6 LUMBER - 8 FOOT LONG FOR DOOR SHELVES AND FRAMING (USE 6 FT. LENGTHS IF AVAILABLE)
5	3-1/2" x 3-1/2" - FAST - PIN ZINC - COATED HINGES FOR DOOR
1	KEY LOCK AND LATCH
11/3 SQUARES	ASPHALT OR CEDAR SHINGLES OR CEDAR SHAKES OR BUILT UP 90# ROOFING AS SELECTED
AS REQUIRED	8d COMMON NAILS FOR ROOF, WALL AND DOOR FRAMING
AS REQUIRED	5d, 6d, AND 8d GALVANIZED OR CEMENT-COATED NAILS FOR SIDING AND FLOOR.

THIS OUTDOOR STORAGE HOUSE WILL ADD A DISTINCTIVE AND ATTRACTIVE TOUCH TO YOUR BACK YARD AND STILL STORE ALL YOUR GARDEN TOOLS, SUPPLIES AND PATIO ITEMS. YOU CAN CHOOSE FROM A WIDE RANGE OF PLYWOOD TEXTURES AND FINISHES FOR THE EXTERIOR TREATMENT.

SPECIAL NOTE: BE SURE THAT YOU HAVE REVIEWED AND UNDERSTAND ALL CONSTRUCTION AND HAVE VERIFIED ALL DIMENSIONS BEFORE CUTTING YOUR MATERIALS.

COOPERATIVE EXTENSION WORK IN AGRICULTURE AND HOME ECONOMICS			
AND UNITED STATES DEPARTMENT OF AGRICULTURE COOPERATING			
OUTDOOR GARDEN STORAGE			
APA	'77	6284	SHEET 3 OF 3

¹ GRADE TRADEMARKED PLYWOOD
² BASED ON 8 FOOT LENGTHS
USE PAINT OR STAIN FOR FINISHING