

NOTE:
OFFAL AND HIDE ROOMS MAY BE ON SAME
LEVEL OR LOWERED, DEPENDING ON TERRAIN.

NOTE:
CHECK ROOF REQUIREMENTS WITH STATE OR FEDERAL INSPECTOR.
IF ROOF IS REQUIRED, EXTEND 6" X 6" POSTS AND ADD PLATE TO
SUPPORT TRUSS ROOF. LEAVE RIDGE OPENING FOR VENT.

DESIGN CAPACITY = 10 HEAD PER DAY

NOTE:
ADD COVERED LOADING
AREA, AS REQD.

FLOOR PLAN

12'-0" 1' 2' 3' 4'

NOTES:
THE PURPOSE OF THESE PLANS IS TO SERVE
AS A GUIDE ONLY.
FOR A PLANT TO BE ELIGIBLE FOR OFFICIAL
INSPECTION, DETAILED PLANS MUST BE
SUBMITTED TO YOUR LOCAL HEALTH &
BUILDING CODE AUTHORITIES, FOR APPROVAL
BEFORE CONSTRUCTION IS BEGUN.

BASED ON: VPI & SU PLAN NO. M-1.76

COOPERATIVE EXTENSION WORK IN AGRICULTURE AND HOME ECONOMICS			
AND UNITED STATES DEPARTMENT OF AGRICULTURE COOPERATING			
CUSTOM SLAUGHTERHOUSE			
VA	'77	6270	SHEET 1 OF 4

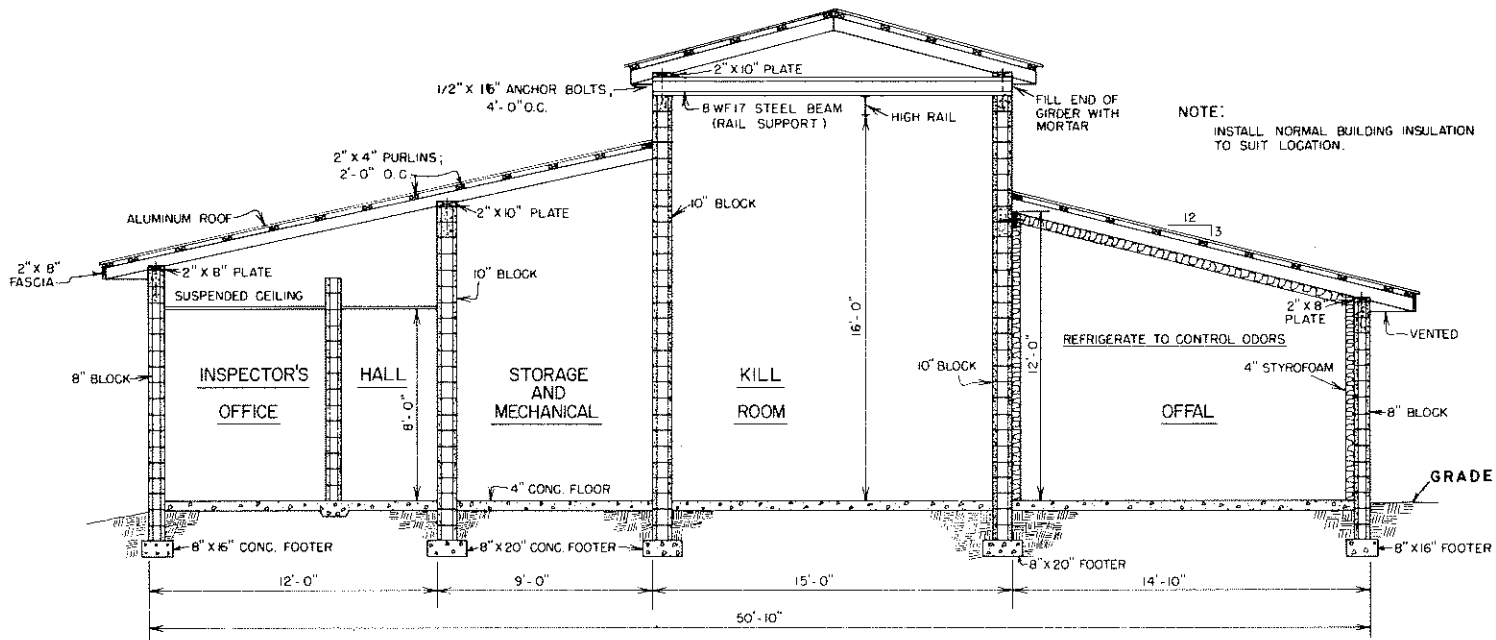

SECTION A-A

EXTEND FOOTINGS TO FIRM BASE BELOW FROST LINE

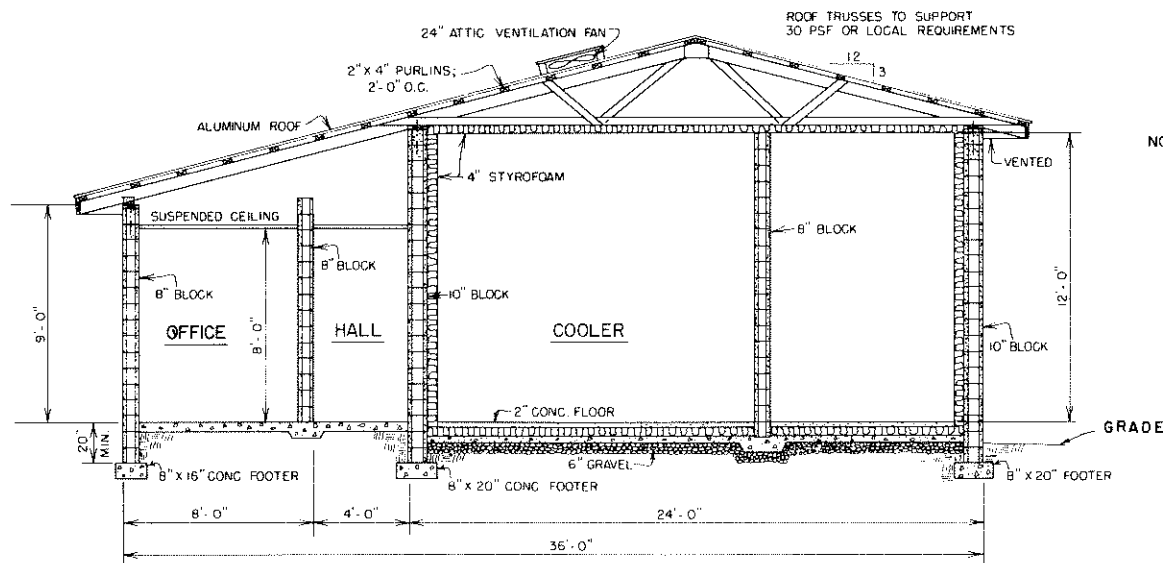

SECTION B-B



COOPERATIVE EXTENSION WORK IN AGRICULTURE AND HOME ECONOMICS		
AND UNITED STATES DEPARTMENT OF AGRICULTURE COOPERATING		
CUSTOM SLAUGHTERHOUSE		
VA '77	6270	SHEET 2 OF 4

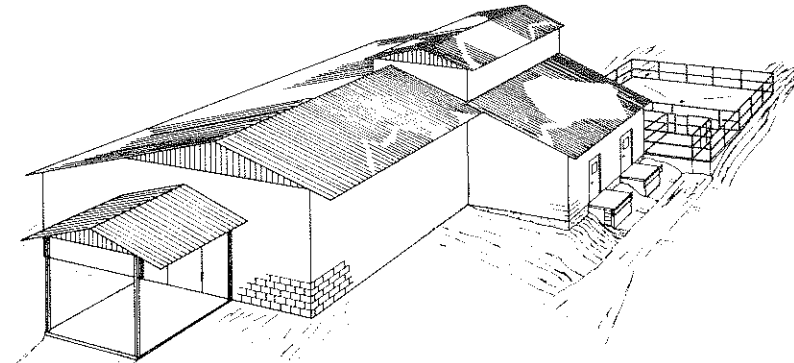

PERSPECTIVE
NO SCALE

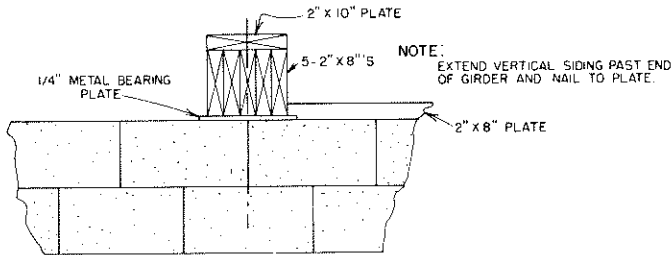
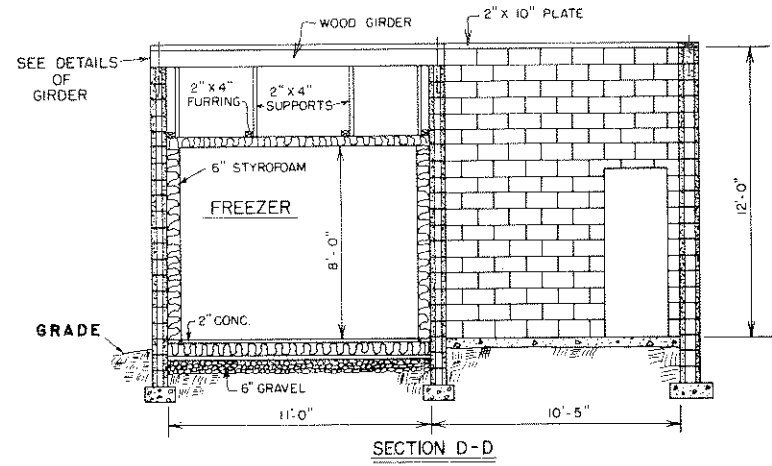

DETAIL OF OUTSIDE END OF GIRDER

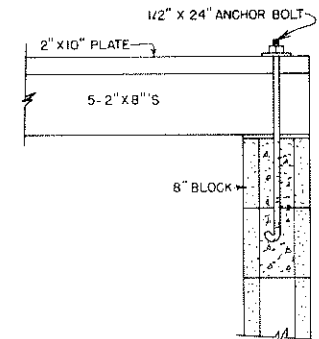

DETAIL OF INSIDE END OF GIRDER

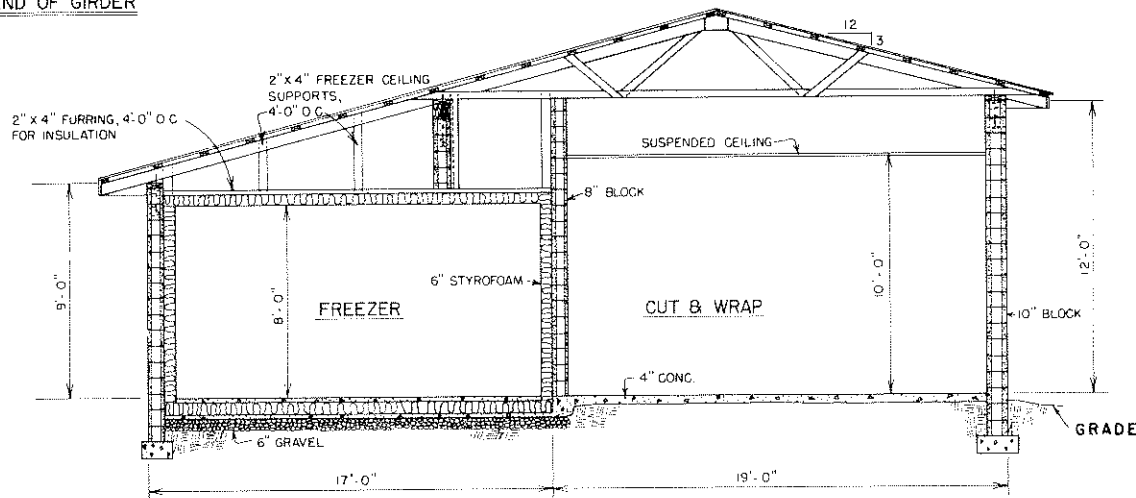

SECTION C-C

12' 9" 6" 3" 0









EXTEND FOOTINGS TO FIRM BASE
BELOW FROST LINE

COOPERATIVE EXTENSION WORK IN
AGRICULTURE AND HOME ECONOMICS

AND
UNITED STATES DEPARTMENT OF AGRICULTURE COOPERATING

CUSTOM SLAUGHTERHOUSE

VA '77 6 2 7 0 SHEET 3 OF 4

ELECTRICAL SYMBOLS	
	CEILING OUTLET W/INCANDESCENT FIXTURE
	CEILING OUTLET W/FLOURESCENT FIXTURE
	FLOURESCENT FIXTURE IN CONTINUOUS ROW
	RECEPTACLE OUTLET, DUPLEX GROUNDING TYPE
	INDICATES SWITCH CONTROL
	LOCAL SWITCH, SINGLE POLE
	LOCAL SWITCH, 3 WAY
	ELECTRIC BASEBOARD HEATER

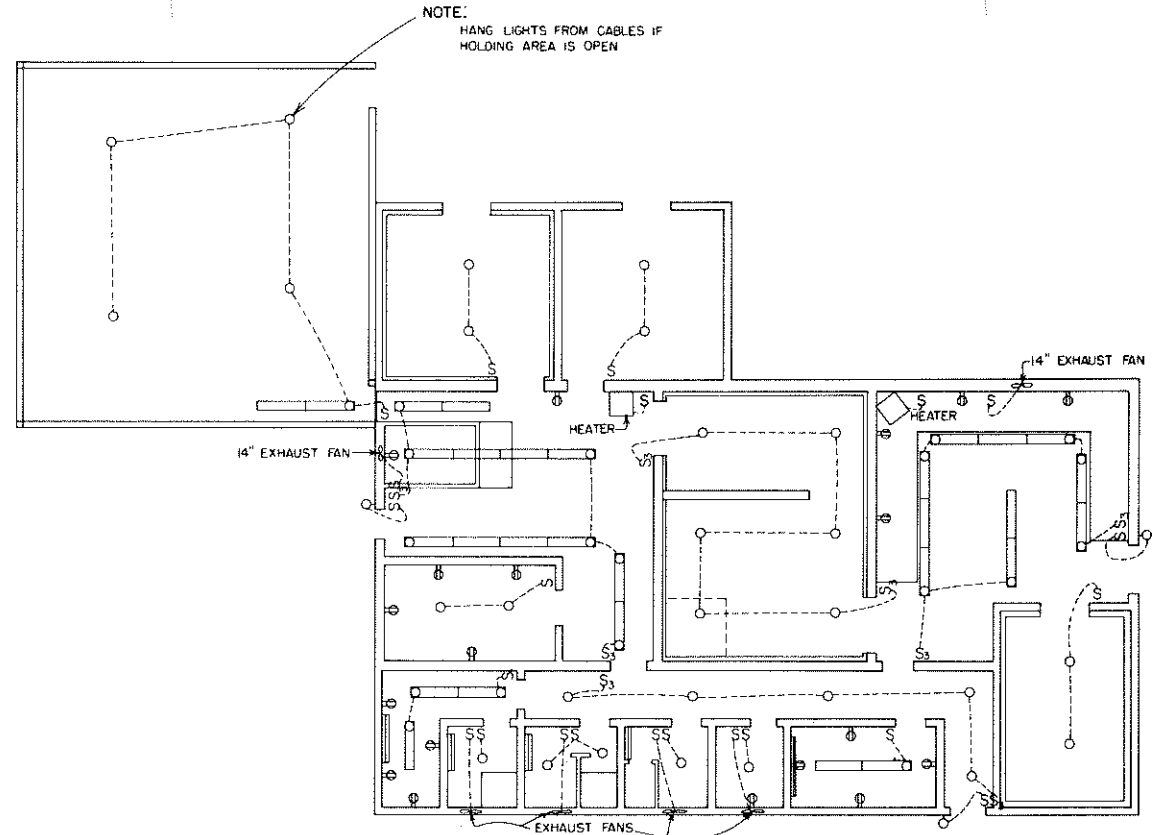

ELECTRICAL LAYOUT

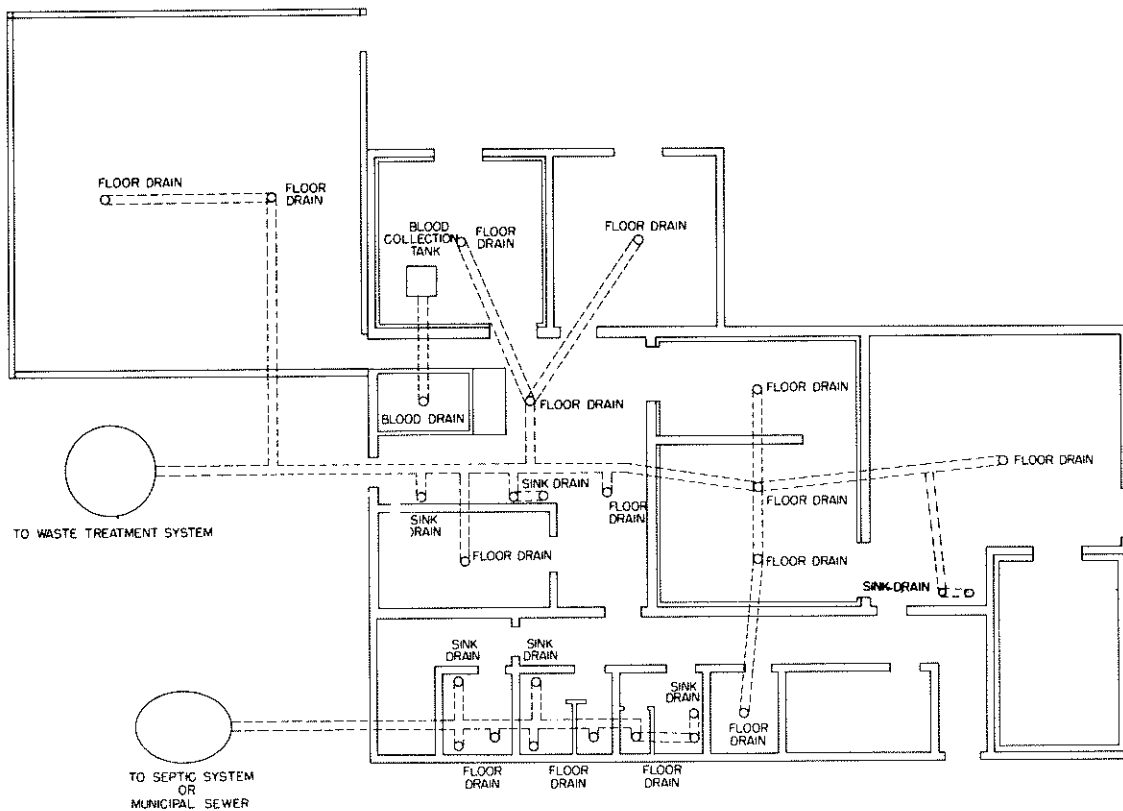

DRAIN SYSTEMS

NOTE:

ALL DRAINS TO BE EQUIPPED WITH A DEEP SEAL TRAP & PROPERLY VENTED USE RODENT SCREENS WHERE NECESSARY.

COOPERATIVE EXTENSION WORK IN AGRICULTURE AND HOME ECONOMICS		
AND UNITED STATES DEPARTMENT OF AGRICULTURE COOPERATING		
CUSTOM SLAUGHTERHOUSE		
VA	'77	6 2 7 0
		SHEET 4 OF 4