

NOTES:
 SLOPE ALL GUTTERS TOWARD DRAINS.
 FARROWING CRATES 5'-0" X 9'-0"
 V.D. = 4' X 8' VENTILATING DOOR EXCEPT AS OTHERWISE NOTED.

FLOOR PLAN

SCALE: 1/4" = 1'-0"
 0 1 2 3 4 5

ELECTRICAL LEGEND

- ⊕ DUPLEX CONVENIENCE OUTLET, CEILING MOUNTED OR STUBBED FROM FLOOR 2' HIGH. (FOR HEAT LAMPS.)
 - ⊕ CEILING FIXTURE PORCELAIN KEYLESS. 100W. MINIMUM - 200W. MAXIMUM.
 - WALL MOUNTED FIXTURE. 14" MIN. DIA. REFLECTOR.
 - ▽ SPECIAL PURPOSE OUTLET.
 - S₃ THREWAY WALL SWITCH.
 - S SINGLE POLE WALL SWITCH.
- ALL WIRING SHALL CONFORM TO THE NATIONAL ELECTRIC CODE'S STANDARDS.

12 0 1 2 3 4 5 6 7 8

SCALE: 1/8" = 1'-0" UNLESS OTHERWISE NOTED.

COOPERATIVE EXTENSION WORK IN AGRICULTURE AND HOME ECONOMICS

AND UNITED STATES DEPARTMENT OF AGRICULTURE COOPERATING

20 SOW FARROWING HOUSE
 EXPANDED METAL SLATTED FLOOR

MISS. '75 6201 SHEET 1 OF 3

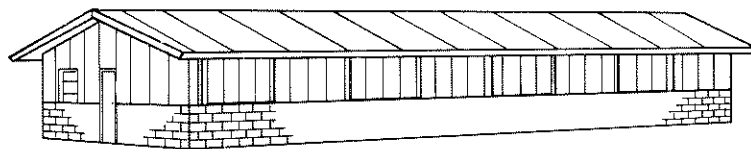

PERSPECTIVE

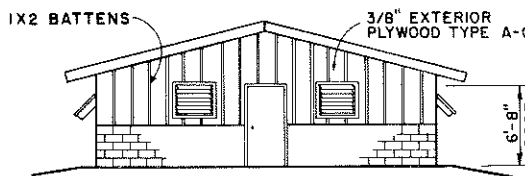

REAR ELEVATION

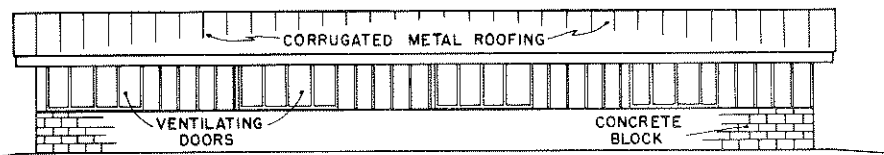

SIDE ELEVATION

NOTE:
 CONSULT LOCAL HEALTH AND BUILDING CODE AUTHORITIES BEFORE STARTING CONSTRUCTION.

BASED ON: MISS. STATE UNIV. PLAN 6032-A

NOTES:

ALL LUMBER TO BE STRESS GRADED TO FIBER STRESS IN BENDING, AND 1350 P.S.I. IN COMPRESSION.

ALL PROJECTING NAILS TO BE CLINCHED.

TRUSSES SHOULD BE SECURELY ANCHORED TO THE SUPPORTING STRUCTURES.

NOTE:

CHECK ANGLE ON THE JOB. ALL OTHER CUTS ARE MADE AFTER THE TRUSS IS ASSEMBLED.

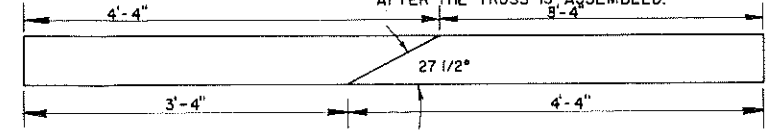
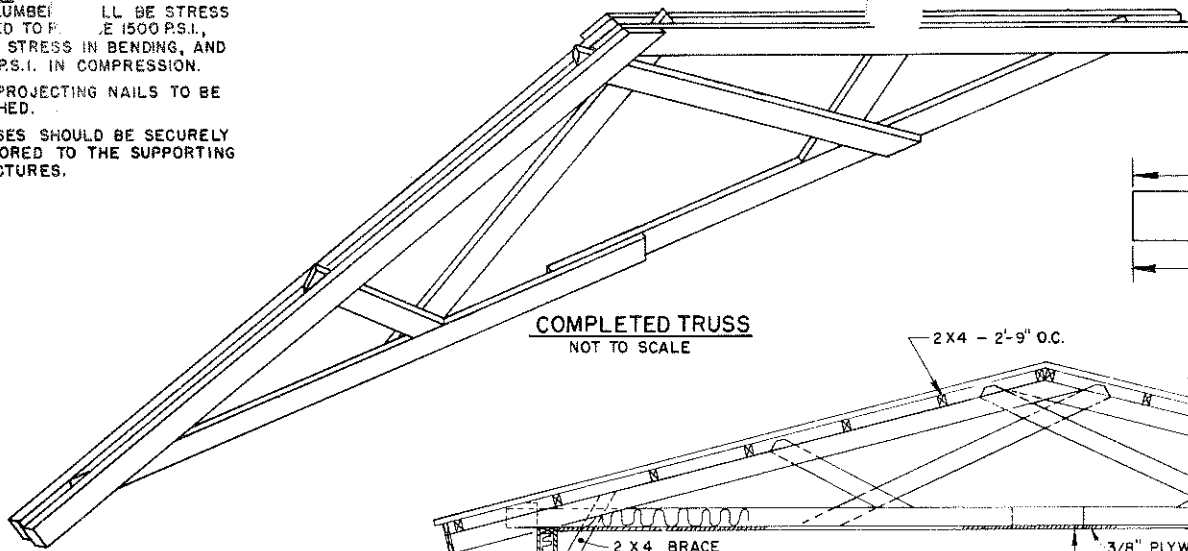

CUTTING DIAGRAM FOR SHORT WEB

SCALE: 1/2" = 1'-0"
12' 6" 0" 1' 2" 3"

TRUSS 4'-0" O.C. USE TRUSS SHOWN. LAP NAIL & SPACE AS SPECIFIED.

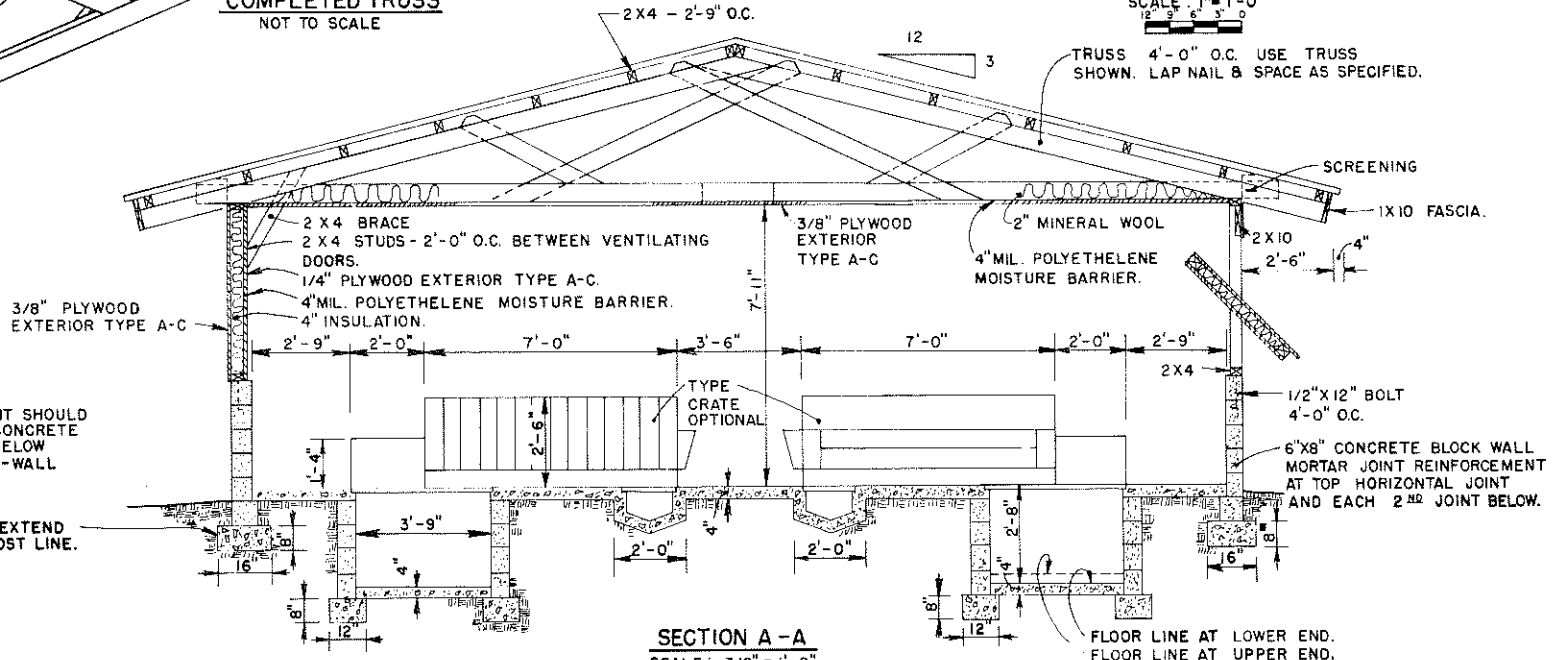

SECTION A-A

SCALE: 3/8" = 1'-0"
12' 6" 0" 1' 2" 3"

NOTE NO. 1.

MORTAR JOINT REINFORCEMENT SHOULD BE USED ON CONCRETE BLOCK WALL BELOW GROUND DURO-WALL OR EQUAL.

FOOTINGS EXTEND BELOW FROST LINE.

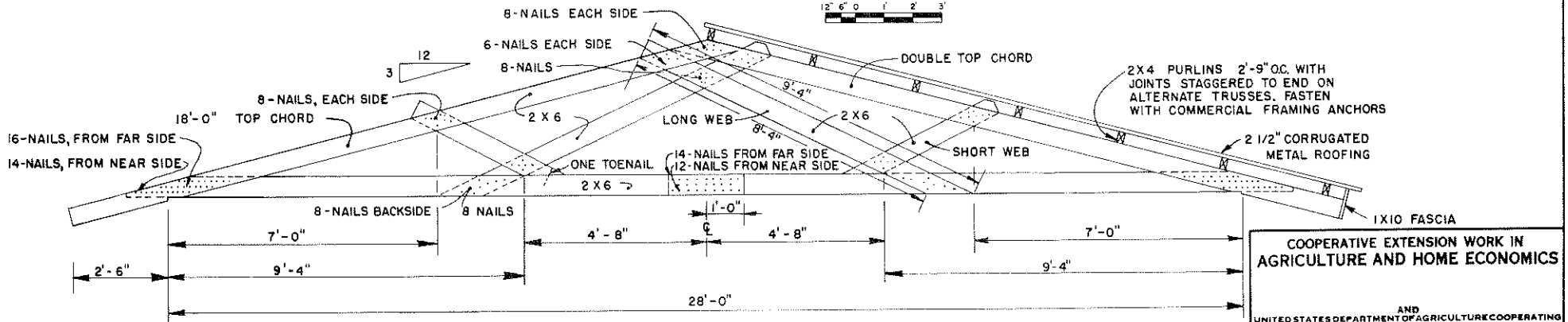

ELEVATION & JOINT DETAILS

SCALE: 1/2" = 1'-0"
12' 6" 0" 1' 2" 3"

COOPERATIVE EXTENSION WORK IN AGRICULTURE AND HOME ECONOMICS

AND UNITED STATES DEPARTMENT OF AGRICULTURE COOPERATING

20 SOW FARROWING HOUSE
EXPANDED METAL SLATTED FLOOR

MISS. '75 6201 SHEET 2 OF 3

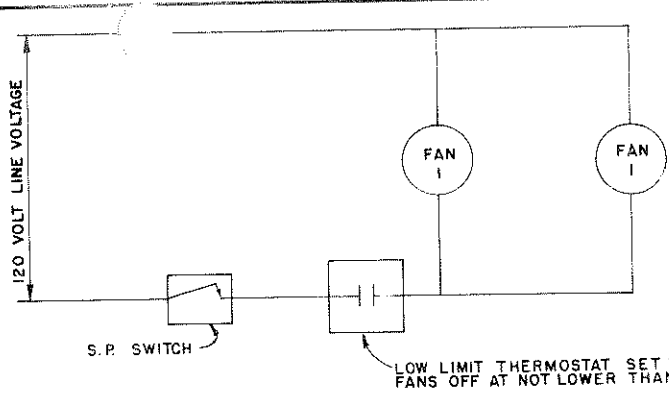

**SCHMATIC DIAGRAM OF FAN N^o 1.
TWO REQUIRED FOR SUMMER VENTILATION.**

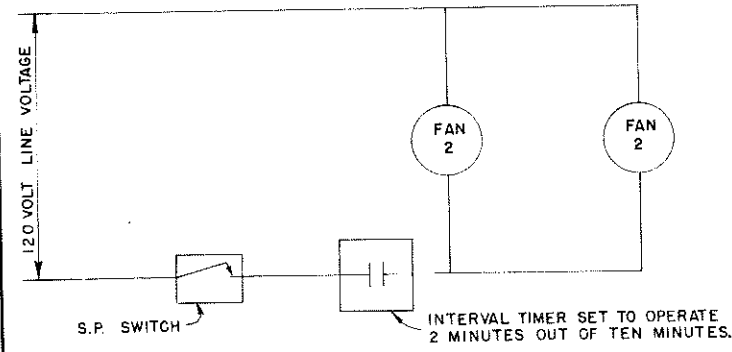

**SCHMATIC DIAGRAM OF FAN N^o 2.
TWO REQUIRED FOR WINTER VENTILATION.**

FAN SPECIFICATIONS
 FAN N^o 1 - 10,000 C.F.M. @ 1/8" GAGE
 STATIC PRESSURE MOTOR SHUTTER.
 FAN N^o 2 - 1,000 C.F.M. @ 1/8" WATER GAGE
 STATIC PRESSURE.

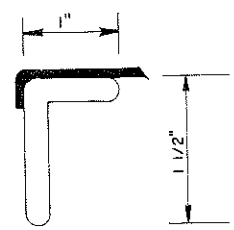

EXPANDED, FLATTENED METAL STYLE
 5/8" - 9 - 11 MESH SIZE 3/8" X 1 1/2" K.

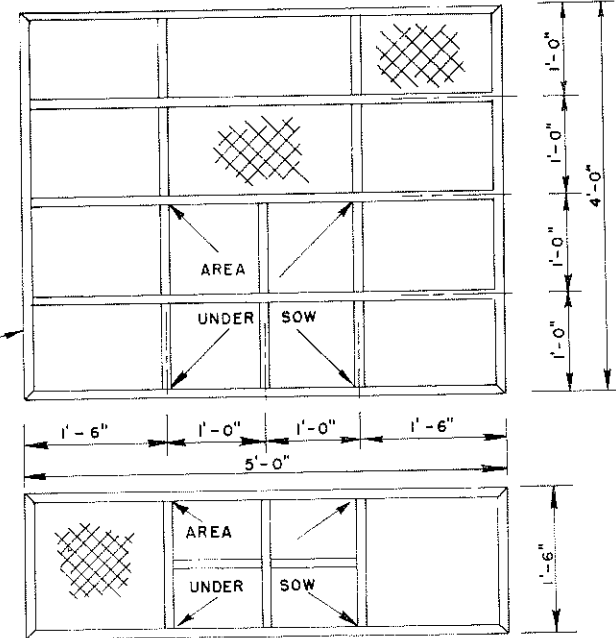

**PLAN
EXPANDED METAL GRATINGS OVER PIT**
 SCALE: 1" = 1'-0"

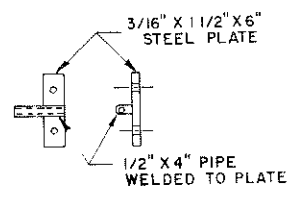

SIDE DOOR HINGE DETAIL
 SCALE: 1 1/2" = 1'-0"

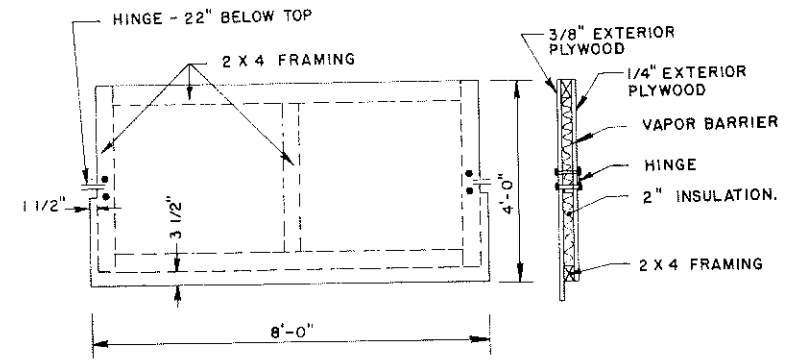

VENTILATOR DOOR DETAIL
 SCALE: 1/2" = 1'-0"

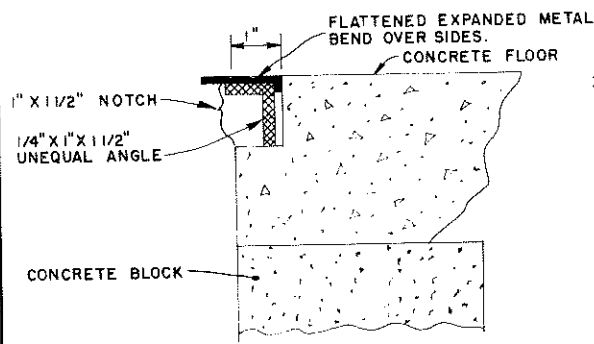

**DETAIL "A"
JOINT OF GRATING AND CONCRETE FLOOR**
 NOT TO SCALE

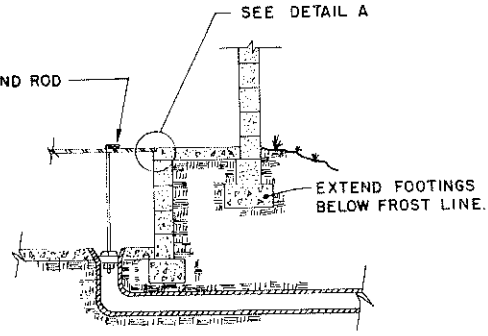

SECTION "B-B"
 SCALE: 3/8" = 1'-0"

COOPERATIVE EXTENSION WORK IN
 AGRICULTURE AND HOME ECONOMICS

AND
 UNITED STATES DEPARTMENT OF AGRICULTURE COOPERATING

20 SOW FARROWING HOUSE
 EXPANDED METAL SLATTED FLOOR

MISS. '75 6201 SHEET 3 OF 3