

LEFT SIDE VIEW

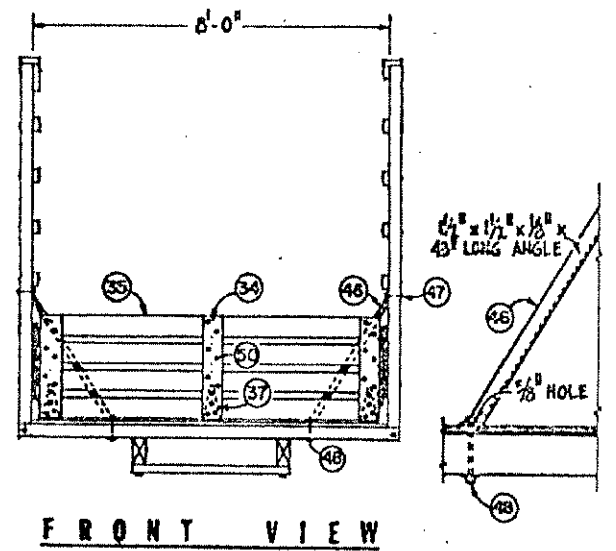

FRONT VIEW

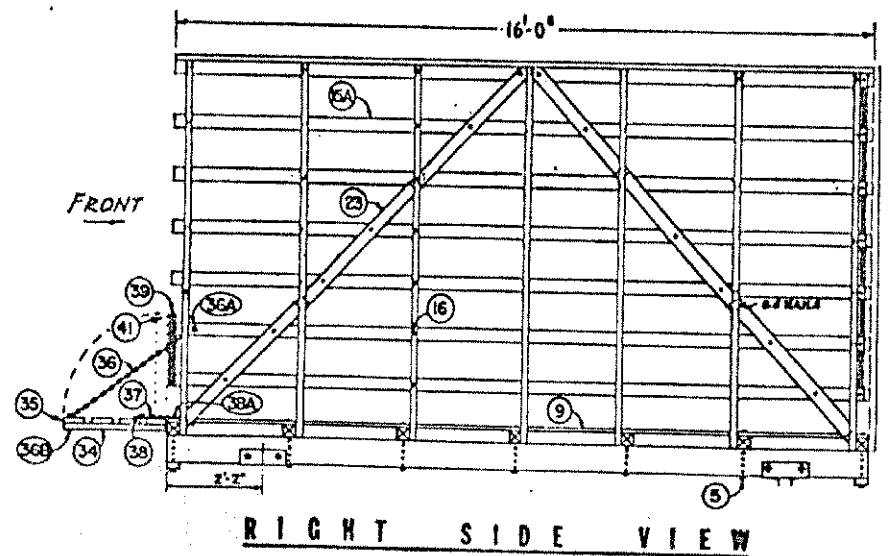

RIGHT SIDE VIEW

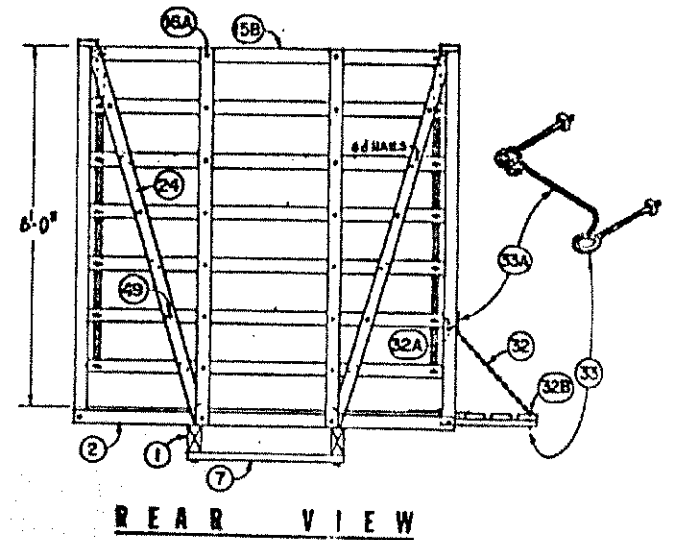
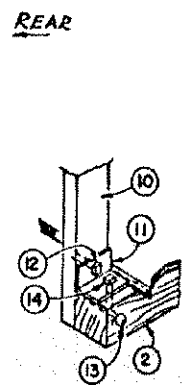
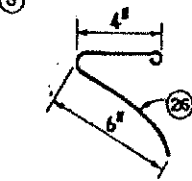

REAR VIEW



BASED ON: UNIV. OF WISC. PLAN 300N.

COOPERATIVE EXTENSION WORK IN
 AGRICULTURE AND HOME ECONOMICS
 AND
 UNITED STATES DEPARTMENT OF AGRICULTURE COOPERATIVE
 WAGON RACK FOR TOSSED BALES
 SIDE & FRONT OPENING
 WISC. '73 EX. 6173 SHEET 1 OF 2

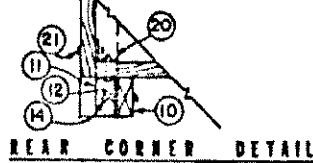
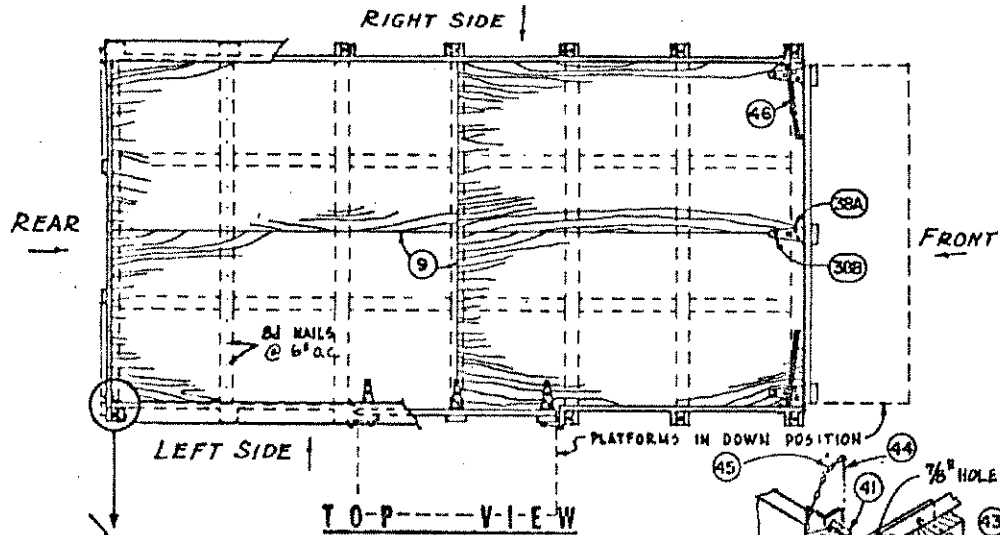

REAR CORNER DETAIL

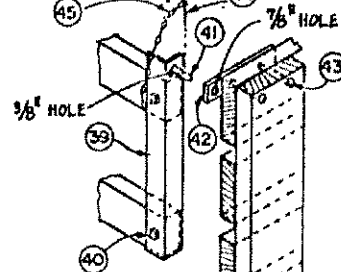

FRONT PLATFORM LATCH

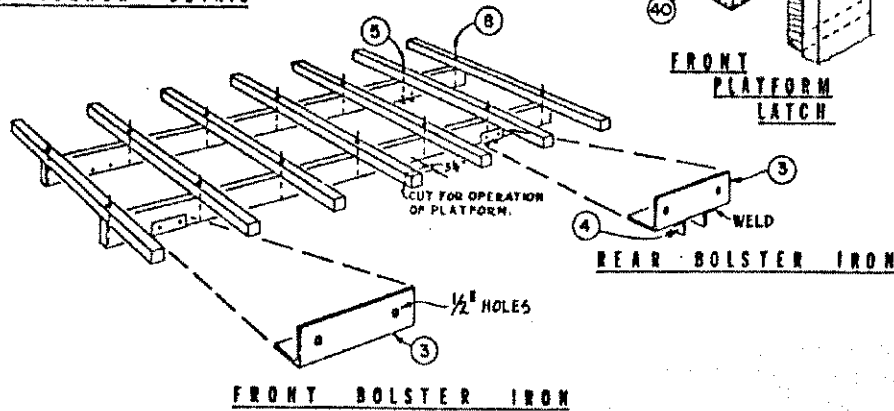

FRONT BOLSTER IRON

REAR BOLSTER IRON

PART NO.	NAME	NO. PCS.	DIMENSIONS
1	RAIL SILL	2	4" x 8" x 16'
2	CROSS SILLS	7	4" x 4" x 8' 7"
3	BOLSTER IRON	4	4" x 4" x 1/4" x 12" ANGLE IRON
4	BOLSTER IRON	4	2" x 2" x 1/4" x 4" ANGLE IRON
5	BOLTS FOR CROSS SILLS	10	1/2" x 12" CARRIAGE BOLTS
6	BOLTS FOR BOLSTER IRON	8	1/2" x 4" x 1/2" CARRIAGE BOLTS
7	CROSS TIE	2	2" x 4" x 42" ±
8	BOLTS END CROSS SILLS	4	1/2" x 13" CARRIAGE BOLTS
9	FLOOR	4	3/4" x 4" x 8" EXTERIOR PLYWOOD
10	STUDDING	15	2" x 4" x 8' 4"
11	BRACKET	13	2" x 2 1/2" x 1/4" - 3 1/2" ANGLE IRON
12	BOLTS FOR BRACKET	13	3/8" x 2" CARRIAGE BOLTS
13	BOLTS FOR STUDDING	15	3/8" x 5 1/2" CARRIAGE BOLTS
14	BOLTS FOR BRACKET	13	3/8" x 4" CARRIAGE BOLTS
15	SIDE RAIL	12	2" x 4" x 5' 8" ±
15A	SIDE RAIL	7	2" x 4" x 16'
15B	REAR RAIL	7	2" x 4" x 8'
16	BOLTS FOR SIDE RAILS	97	3/8" x 5 1/2" CARRIAGE BOLTS
16A	BOLTS FOR REAR RAILS	14	3/8" x 3 1/2" CARRIAGE BOLTS
17	TOP RAIL	1	2" x 8" x 16'
18	TOP CAP	2	2" x 6" x 16'
19	LAG SCREWS FOR TOP CAP	16	3/8" x 4"
20	CORNER ANGLE	2	2" x 2" x 3/16" x 7' 3" ANGLE IRON
21	BOLTS FOR CORNER ANGLE	28	3/8" x 2 1/2" MACHINE BOLTS
22	BRACES	2	2" x 4" x 10"
23	BRACES	2	2" x 4" x 11"
24	BRACES	2	2" x 4" x 8' 9"
25	CHAIN	5	3/16" PROOF COIL CHAIN 5'
26	CHAIN HOOK	5	1/4" ROD 12"
27	BOLTS FOR CHAIN	10	3/8" x 2 1/2" MACHINE BOLTS
28	FOLDING PLATFORM	4	2" x 6" x 4' 6" ±
29	FOLDING PLATFORM	3	2" x 6" x 2' 4"
30	BOLTS FOR PLATFORM	18	3/8" x 3 1/2" CARRIAGE BOLTS
31	HINGES FOR PLATFORM	1 1/2 PR.	6" STRAP HINGES
31A	BOLTS FOR HINGES	8	5/16" x 3 1/2" CARRIAGE BOLTS
31B	BOLTS FOR HINGES	4	5/16" x 5" CARRIAGE BOLTS
31C	BOLTS FOR HINGES	12	5/16" x 3 1/2" CARRIAGE BOLTS
32	CHAIN SUPPORT	2	3/16" PROOF COIL CHAIN 3 1/2'
32A	CHAIN SUPPORT BOLTS	2	3/8" x 2 1/2" CARRIAGE BOLTS
32B	CHAIN SUPPORT BOLTS	2	3/8" x 4" CARRIAGE BOLTS
33	EYE BOLT	4	1/4" x 4" EYE BOLT
33A	HOOK	2	HOOK 6" OR MORE
34	FRONT PLATFORM	3	2" x 6" x 2' 4"
35	FRONT PLATFORM	4	2" x 6" x 7' - 8 3/4"
36	CHAIN SUPPORT	2	3/16" PROOF COIL 3 1/2"
36A	CHAIN SUPPORT BOLTS	2	3/8" x 2 1/2" CARRIAGE BOLTS
36B	CHAIN SUPPORT BOLTS	2	3/8" x 4" CARRIAGE BOLTS
37	HINGES	1 1/2 PR.	10" STRAP HINGES
38	BOLTS FOR HINGES	12	5/16" x 3 1/2" CARRIAGE BOLTS
38A	BOLTS FOR HINGES	6	5/16" x 5" CARRIAGE BOLTS
38B	BOLTS FOR HINGES	6	5/16" x 1 1/2" CARRIAGE BOLTS
39	FRONT LATCH PART	2	2" x 2" x 1/4" x 1' 8" ANGLE IRON
40	BOLTS FOR FRONT LATCH	4	3/8" x 2 1/2" CARRIAGE BOLTS
41	FRONT LATCH PIN	2	3/4" x 3" STEEL WELD TO ANGLE
42	FRONT LATCH PART	2	3/8" x 1 1/2" x 7" STEEL
43	BOLTS FOR PART 42	4	3/8" x 4" MACHINE BOLTS
44	COTTER PIN	2	1/4" x 3"
45	CHAIN	2	1/16" LINK STOCK - 6"
46	BRACE	2	1 1/2" x 1 1/2" x 1/8" x 5 1/2" ANGLE
47	BOLTS FOR BRACE	2	3/8" x 4 1/2" MACHINE BOLTS
48	BOLTS FOR BRACE	2	3/8" x 5" MACHINE BOLTS
49	BOLTS FOR BRACE	26	3/8" x 3 1/2" CARRIAGE BOLTS
	PLAIN WASHERS	300	3/8"
	PLAIN WASHERS	24	1/2"
	RAILS	1 #	8 d NAILS

BOLT LENGTHS FOR STANDARD DIMENSION OF COMMERCIAL LUMBER
 50 BOLTS FOR FRONT PLATFORM 18 3/8" x 3 1/2" CARRIAGE BOLTS

COOPERATIVE EXTENSION WORK IN
 AGRICULTURE AND HOME ECONOMICS

UNITED STATES DEPARTMENT OF AGRICULTURE COOPERATING

WAGON RACK FOR TOSSED BALES
 SIDE & FRONT OPENING

WISC. '73 EX 6173 SHEET 2 OF 2