

NOTES:

- ① LAMP UNIT WITH TIME CLOCK (SEE SHEET 3)
- ② POT HOLDER FRAME (SEE SHEET 2)
- ③ TRAY (SEE SHEET 2)
- ④ WATERING SYSTEM WITH TIME CLOCK (SEE SHEET 2)

COOPERATIVE EXTENSION WORK IN
AGRICULTURE AND HOME ECONOMICS
DEPARTMENT OF AGRICULTURAL ENGINEERING
UNIVERSITY OF MARYLAND
AND
UNITED STATES DEPARTMENT OF AGRICULTURE COOPERATING

PROPAGATION UNIT FOR PLANTS

USDA '70	6101	SHEET 1 OF 3
----------	------	--------------

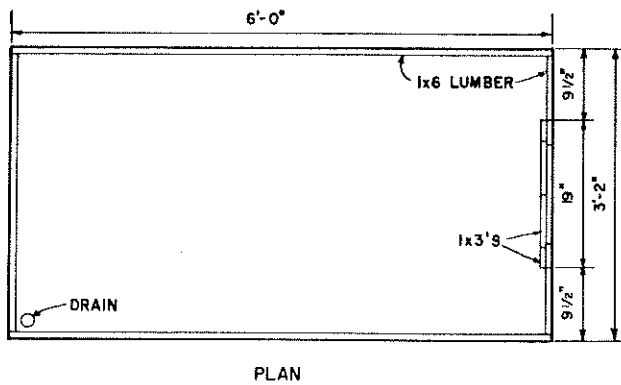

PLAN

NOTE:
LINE TRAY WITH POLYETHYLENE FILM.
SLOPE BOTTOM TOWARD DRAIN HOLE
AND INSTALL SMALL SINK DRAIN FOR
REMOVAL OF EXCESS WATER.

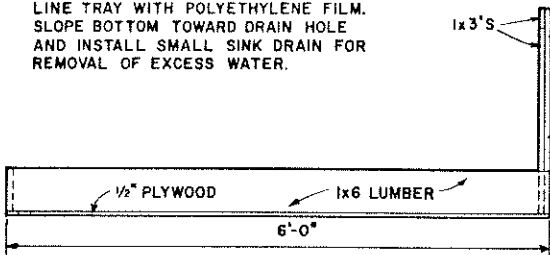

SIDE ELEVATION

DETAILS OF TRAY

SCALE: 0 1 FT.

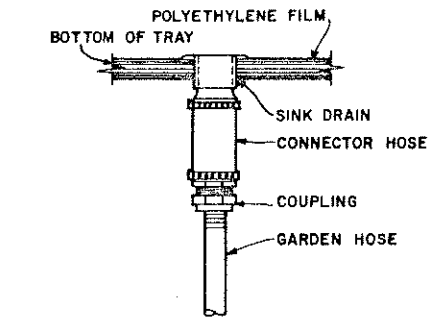

DETAIL OF DRAIN
NO SCALE

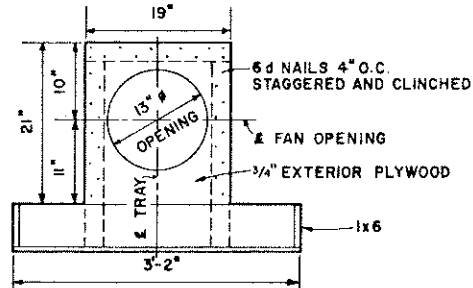

END ELEVATION

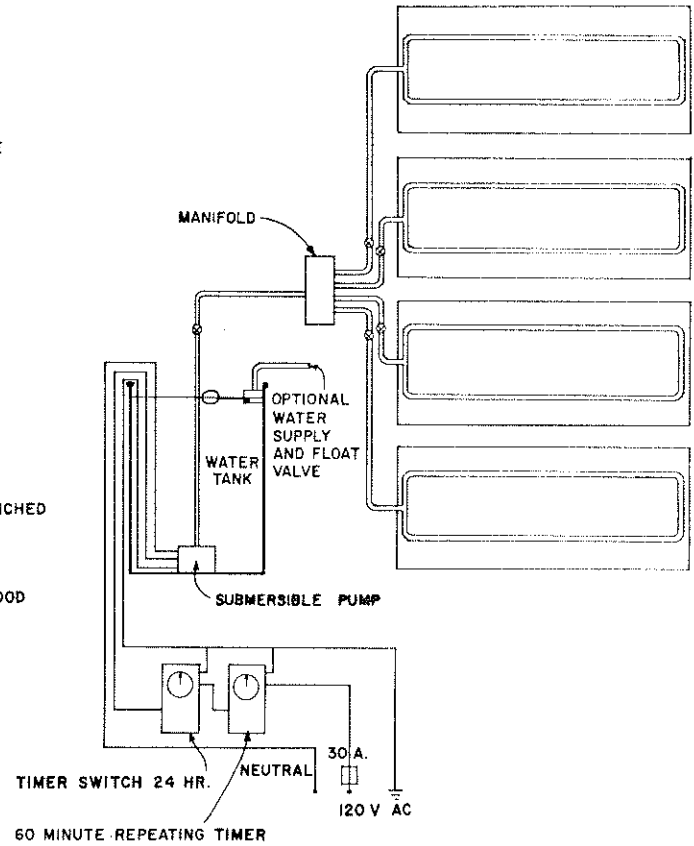

WATERING SYSTEM
WITH TIME CLOCKS
NO SCALE

NOTE:

IF THIS UNIT IS INSTALLED IN A POORLY
VENTILATED OR CLOSED ROOM IT WILL BE
NECESSARY TO AIR CONDITION AS FOLLOWS,
4 FT. LAMP UNITS - 3/4 TON AIR CONDITIONER
6 AND 8 FT. LAMP UNITS - 1 TON AIR CONDITIONER

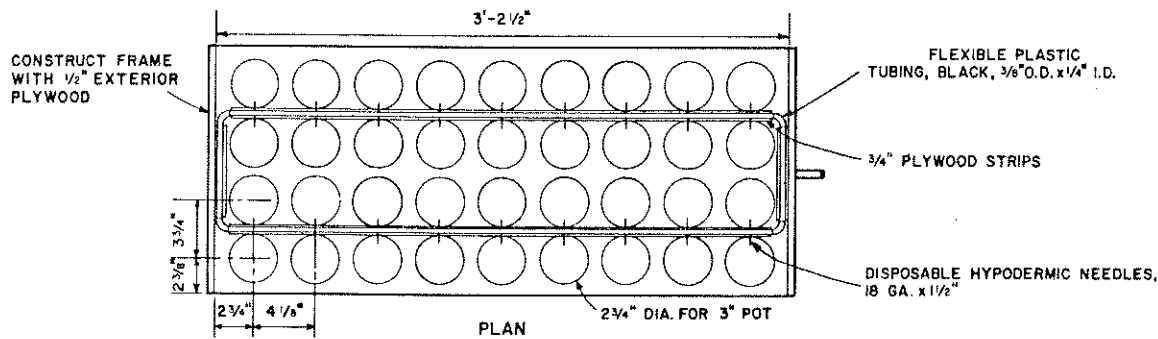

PLAN

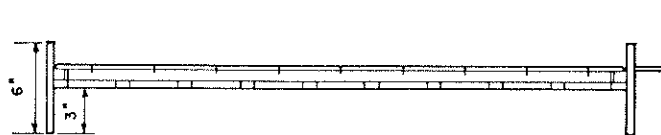

SIDE ELEVATION

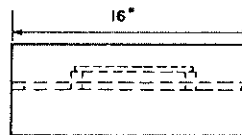

END ELEVATION

DETAILS OF POT HOLDER FRAME
NO SCALE

COOPERATIVE EXTENSION WORK IN AGRICULTURE AND HOME ECONOMICS DEPARTMENT OF AGRICULTURAL ENGINEERING UNIVERSITY OF MARYLAND AND UNITED STATES DEPARTMENT OF AGRICULTURE COOPERATING			
PROPAGATION UNIT FOR PLANTS			
USDA	70	6101	SHEET 2 OF 3

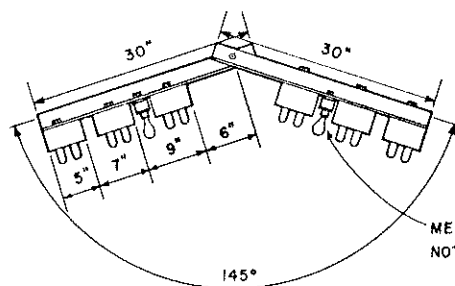
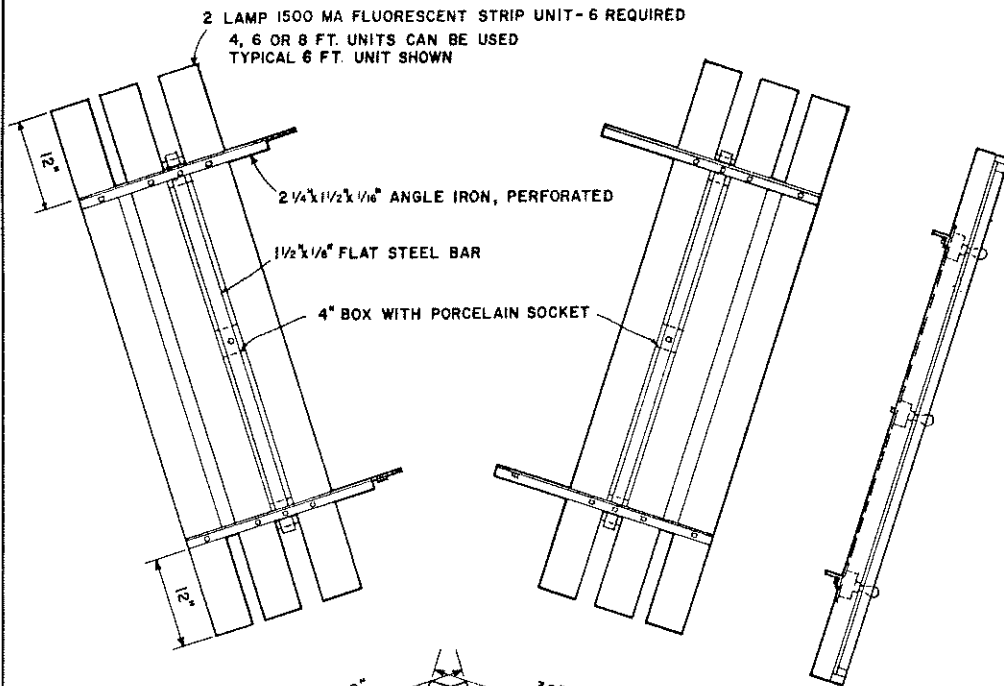

MEDIUM INCANDESCENT SOCKET 24" o.c.
NOTE: INCANDESCENT WATTAGE EQUAL TO 1/4 FLUORESCENT WATTAGE

LAMP UNIT
SCALE: 0 1 FT.

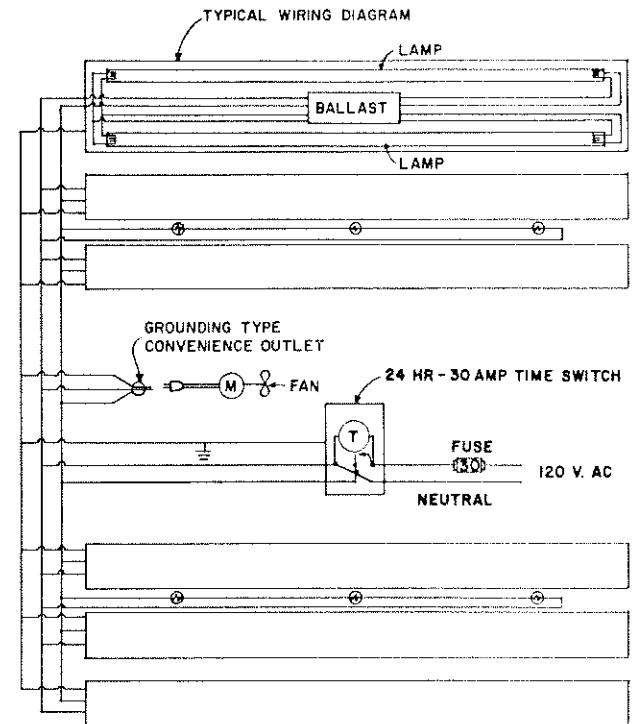

WIRING SCHEMATIC
NO SCALE

NOTE: ALL WIRING MUST MEET THE
LOCAL AND NATIONAL ELECTRICAL CODES

COOPERATIVE EXTENSION WORK IN
AGRICULTURE AND HOME ECONOMICS
DEPARTMENT OF AGRICULTURAL ENGINEERING
UNIVERSITY OF MARYLAND
AND
UNITED STATES DEPARTMENT OF AGRICULTURE COOPERATING

PROPAGATION UNIT FOR PLANTS

USDA '70 6101 SHEET 3 OF 3