

FLOOR PLAN
SCALE: 0 2 4 6 FT.

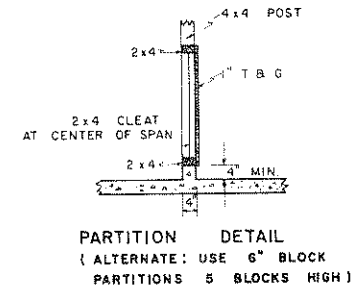

PARTITION DETAIL
(ALTERNATE: USE 6" BLOCK PARTITIONS 5 BLOCKS HIGH)

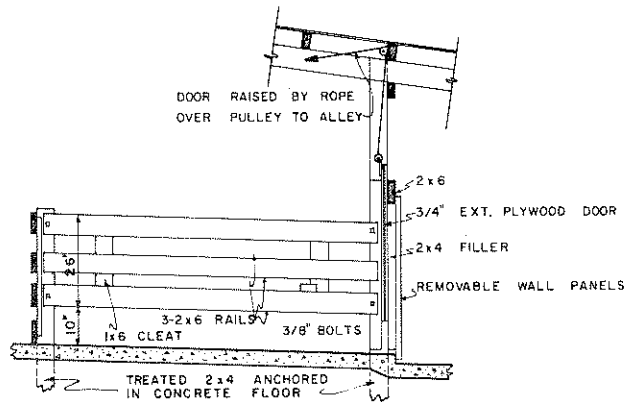

SECTION: A-A
SCALE: 0 1 2 .3 FT.

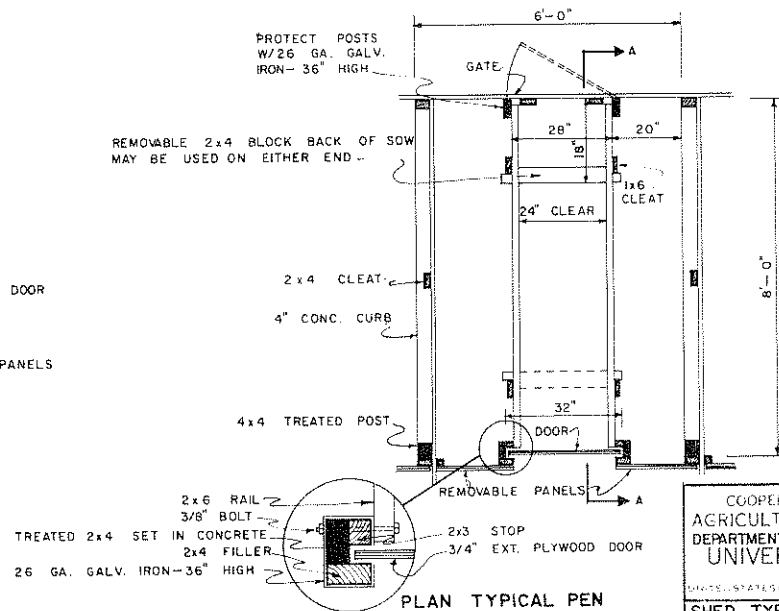

PLAN TYPICAL PEN
SCALE: 0 1 2 3 FT.

COOPERATIVE EXTENSION WORK IN
AGRICULTURE AND HOME ECONOMICS
DEPARTMENT OF AGRICULTURAL ENGINEERING
UNIVERSITY OF MARYLAND
AND
UNITED STATES DEPARTMENT OF AGRICULTURE COOPERATION
SHED TYPE FARROWING HOUSE or
FARROW-TO-FINISH UNIT
N.C. '65 EX 5993 SHEET 1 OF 2

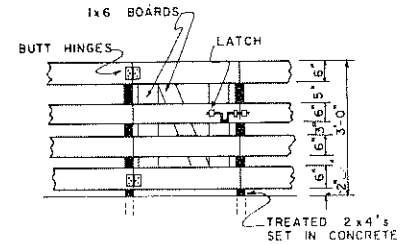
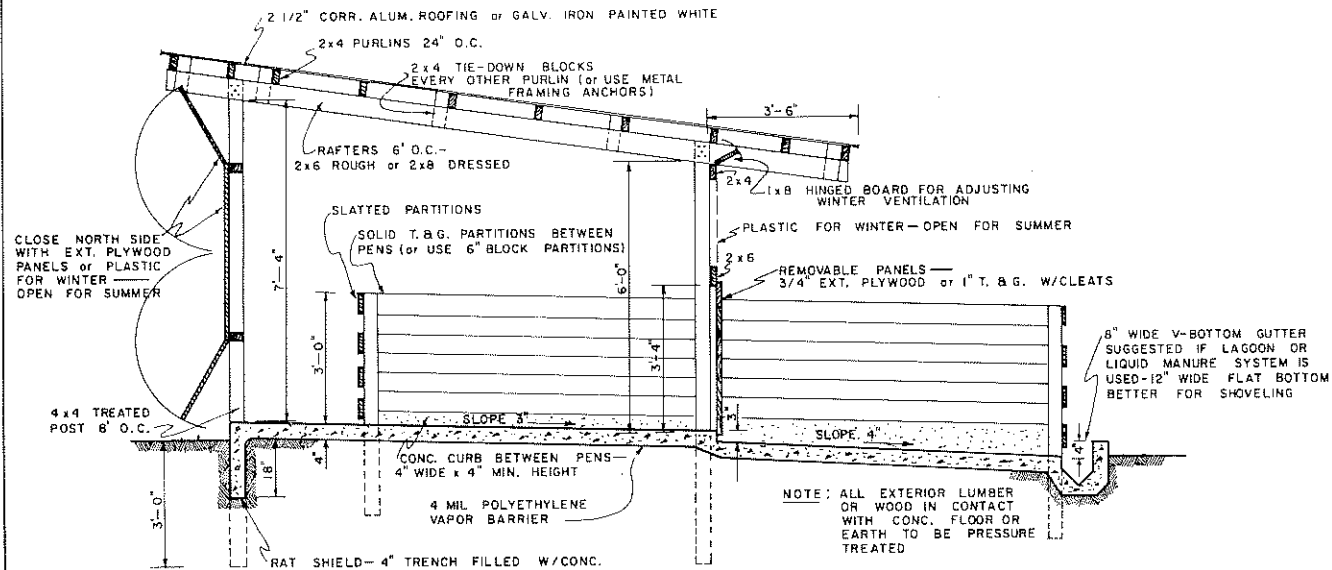

GATE & FENCE DETAIL

SCALE: 0 1 2 3 FT.

CROSS SECTION

SCALE: 0 1 2 3 FT.

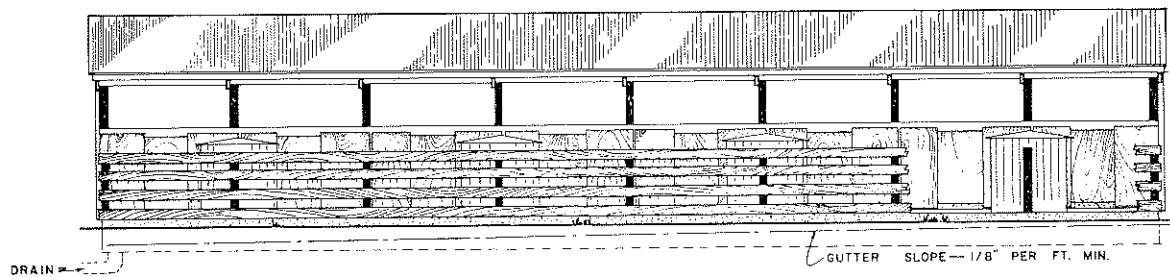

SOUTH SIDE ELEVATION

SCALE: 0 2 4 6 FT.

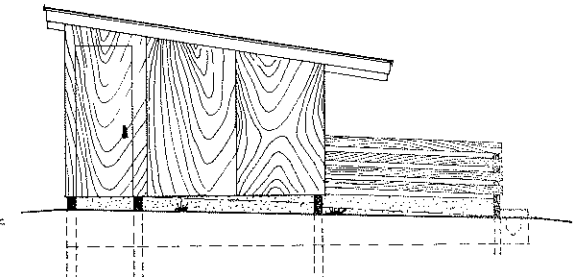

END ELEVATION

SCALE: 0 2 4 6 FT.

COOPERATIVE EXTENSION WORK IN
 AGRICULTURE AND HOME ECONOMICS
 DEPARTMENT OF AGRICULTURAL ENGINEERING
 UNIVERSITY OF MARYLAND
 UNITED STATES DEPARTMENT OF AGRICULTURE COOPERATING
 SHED TYPE FARROWING HOUSE or
 FARROW-TO-FINISH UNIT
 N.C. '65 EX. 5993 SHEET 2 OF 2