

TOP

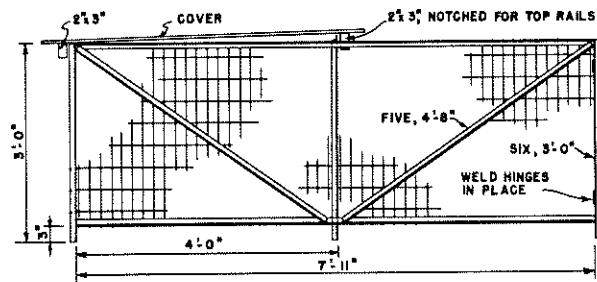

SIDE

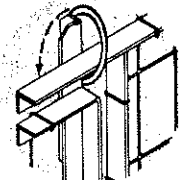

GATE LATCH DETAIL

LOOSE RING ON THE TOP RAIL SLIPS OVER THE UPPER GATE-STOP TO HOLD GATE CLOSED. INSIDE DIAMETER OF RING IS ABOUT 2 1/2"

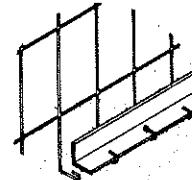

TYPICAL DETAIL

WIRE MESH IS STRETCHED INSIDE FRAME, WIRE ENDS ARE BENT AROUND AND CLINCHED OVER THE TOP AND BOTTOM RAILS, THEN TACK WELDED AT LEAST EVERY 12". CORNER POSTS, SIMILAR.

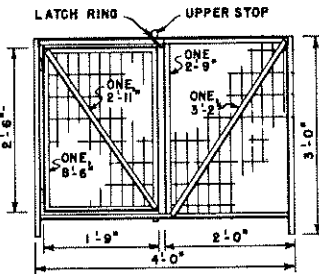

GATE END

STEEL FRAMED PEN

PEN FRAMING IS ALL 1/2"x1"x1" STEEL ANGLES, WELDED. QUANTITIES AND LENGTHS OF PARTS ARE NOTED ON THE DRAWING. UPPER AND LOWER GATE STOPS ARE 6" AND 4" LONG.

AFTER ASSEMBLY, APPLY RUST-INHIBITING PAINT OR ENAMEL TO FRAME AND WIRE MESH.

WIRE MESH: 25 FT. LENGTH COVER IS SIMILAR TO THAT FOR WOODEN PEN, EXCEPT BATTENS ARE RIPPED FROM A 2"x6"

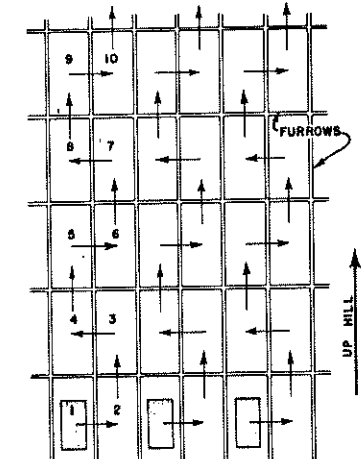

RECOMMENDED MANAGEMENT

PENS ARE MOVED TO CLEAN GROUND AT 7-DAY INTERVALS, AS SHOWN ABOVE. THE PLOWED FURROWS HELP AVOID CONTAMINATION AND IMPROVE DRAINAGE.

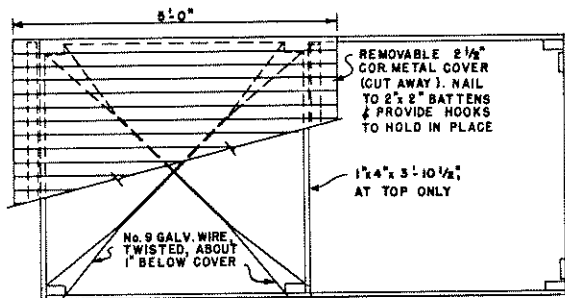

TOP

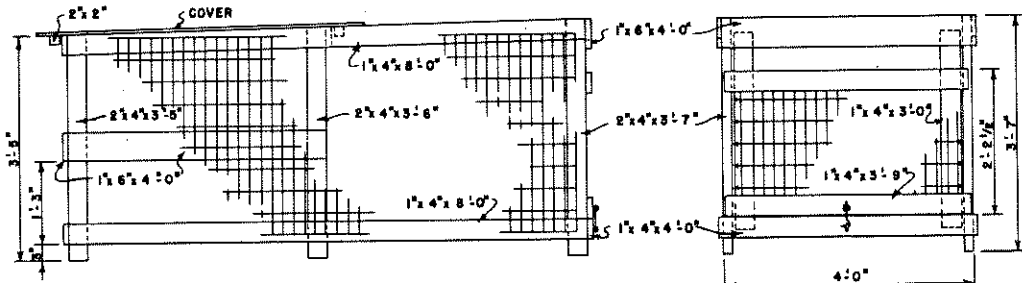

SIDE

GATE END

WOOD-FRAMED PEN

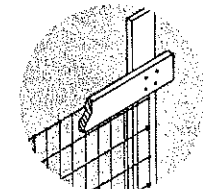

GATE PANEL DETAIL

WIRE MESH EXTENDS BETWEEN BOARDS TO SERVE AS SHIM

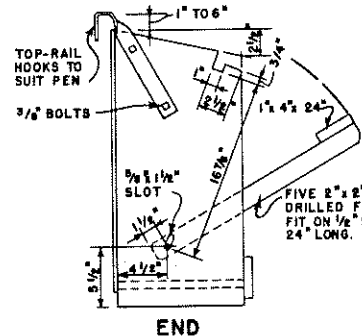

END

FEED RACK

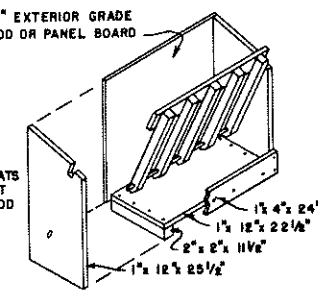

ASSEMBLY

ALL LUMBER SHOULD BE THOROUGHLY SOAKED IN A NON-TOXIC PRESERVATIVE, SUCH AS PENTACHLOROPHENOL OR COPPER NAPHTHENATE, AFTER CUTTING.

ASSEMBLE WITH RUST-PROOF SCREWS, NAILS & STAPLES.

LUMBER:

- 2" x 4" x 7'-0" - 3 PCS
- 2" x 2" x 8'-0" - 1 "
- 1" x 6" x 8'-0" - 2 "
- 1" x 4" x 8'-0" - 7 "
- 1" x 4" x 6'-0" - 1 "

WIRE MESH: 24 FT. LENGTH

TO REMOVE GATE-PANEL, UNHOOK, LIFT UP AND PULL OUT AT THE LOWER EDGE.

WELDED WIRE MESH USED FOR BOTH PENS IS 2" x 4" 1/4" 36" HIGH, GALVANIZED.

COOPERATIVE EXTENSION WORK IN AGRICULTURE AND HOME ECONOMICS  
 DEPARTMENT OF AGRICULTURAL ENGINEERING  
 UNIVERSITY OF MARYLAND  
 AND  
 UNITED STATES DEPARTMENT OF AGRICULTURE COOPERATING

**TWO PORTABLE CALF PENS**

ALA '61 EX. 5933 SHEET 1 OF 1