

FRAMING

FRONT A  
FOR COLDER CLIMATES

ELEVATION

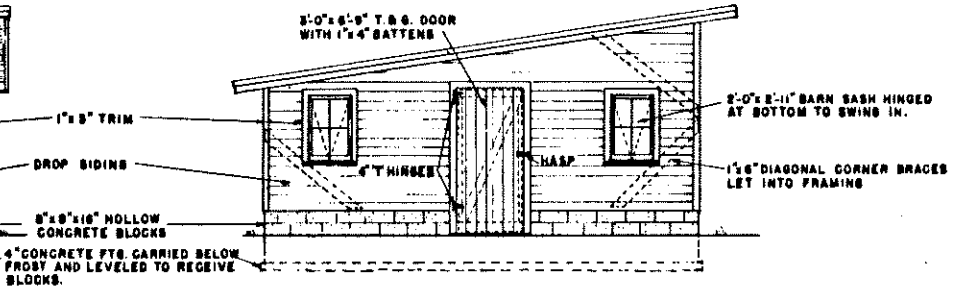

END ELEVATION

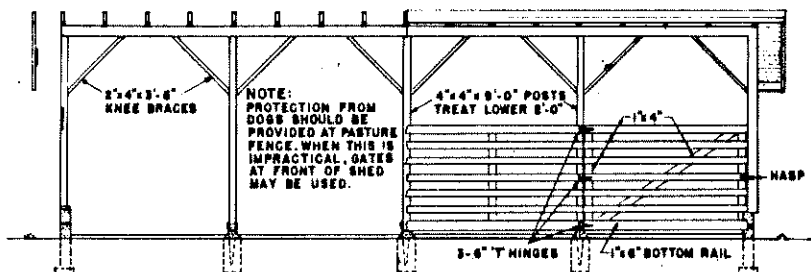

FRAMING

FRONT B  
FOR WARMER CLIMATES

ELEVATION

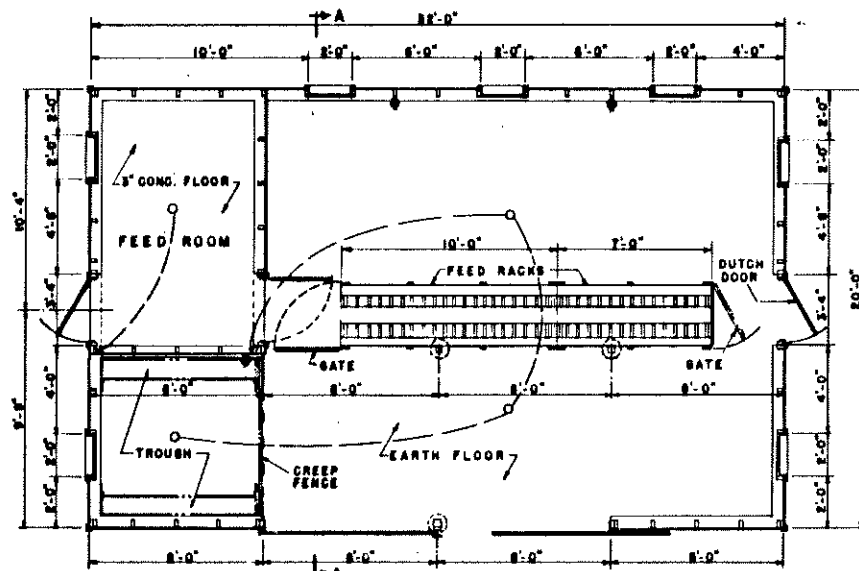

PLAN WITH FRONT A

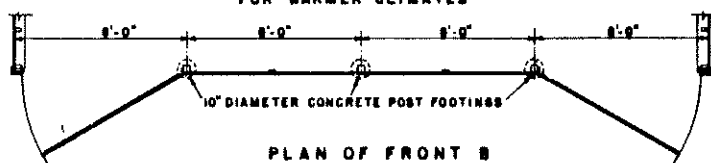

PLAN OF FRONT B

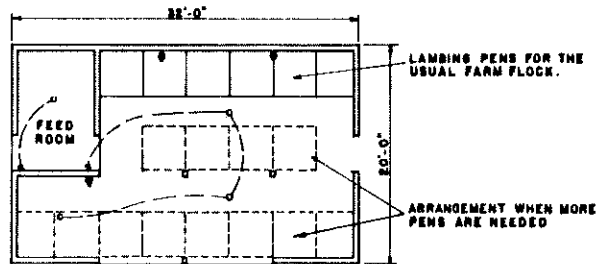

PLAN SHOWING LAMBING PEN  
ARRANGEMENT  
NO SCALE

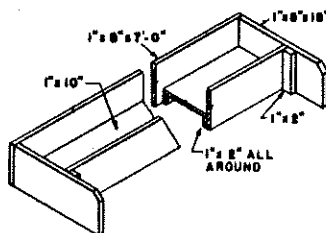

LAMB FEED TROUGH

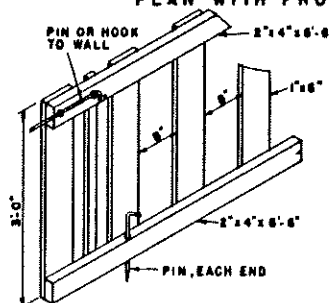

CREEP FENCE

COOPERATIVE EXTENSION WORK IN  
AGRICULTURE AND HOME ECONOMICS

AND  
UNITED STATES DEPARTMENT OF AGRICULTURE COOPERATING

**SHEEP SHED**  
CAPACITY, 32 SHEEP OR 18 LAMBING PENS

USDA '52 EX. 5753 SHEET 1 OF 2

