

SIDE DOOR  
NOT TO SCALE

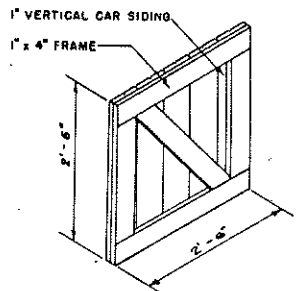

FILLING DOOR  
NOT TO SCALE

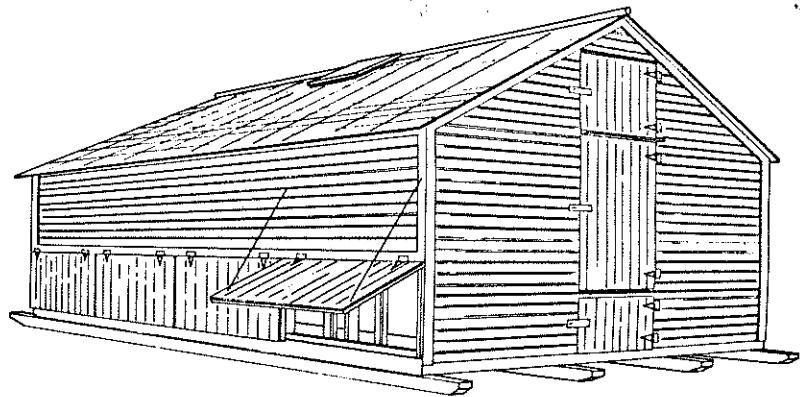

PERSPECTIVE  
NOT TO SCALE

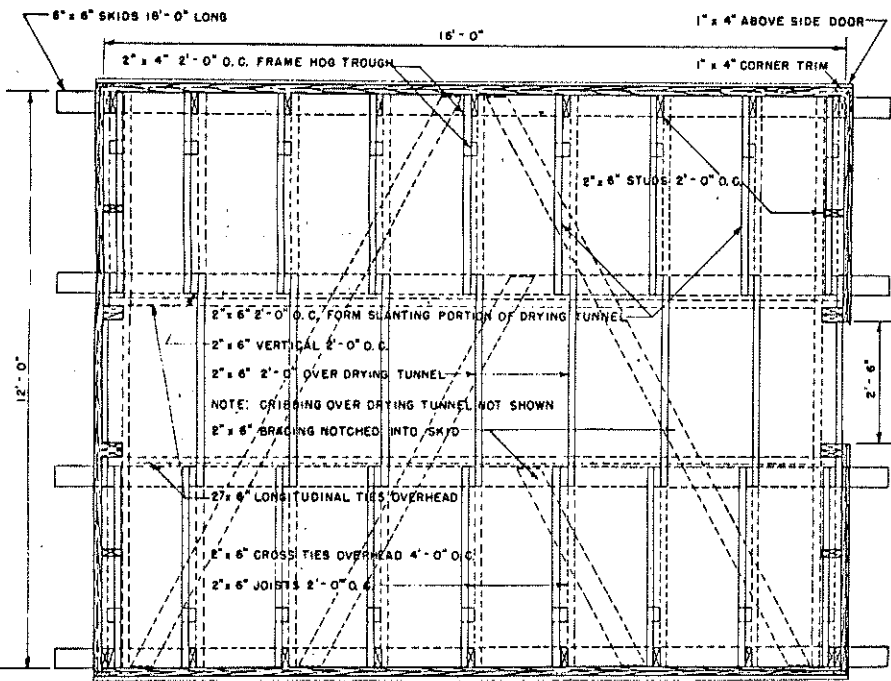

PLAN  
SCALE -  $\frac{3}{8}$ " = 1'-0"

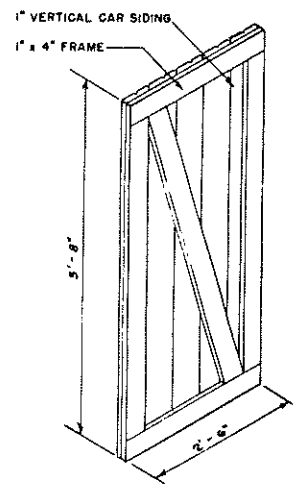

ENTRANCE DOOR  
NOT TO SCALE

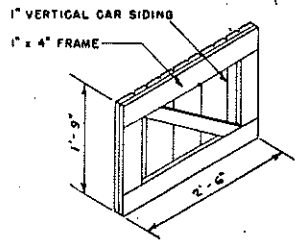

TUNNEL DOOR  
NOT TO SCALE

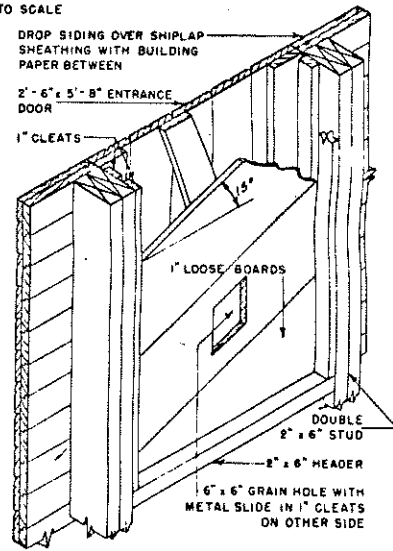

DETAIL AT DOOR  
NOT TO SCALE

COOPERATIVE EXTENSION WORK IN AGRICULTURE AND HOME ECONOMICS		
AND UNITED STATES DEPARTMENT OF AGRICULTURE COOPERATING		
MOVABLE HOG FEEDER, STORAGE & DRIER, GRAIN & EAR CORN		
M.W.	EX. 5725	SHEET 1 OF 2

26  
ceop

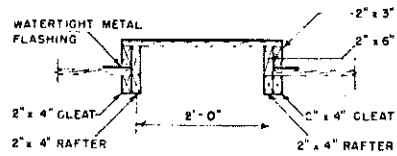
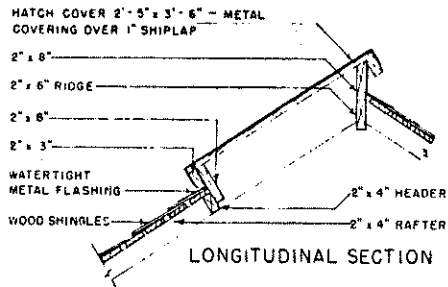

HATCH DETAILS

SCALE - 1/2" = 1'-0"

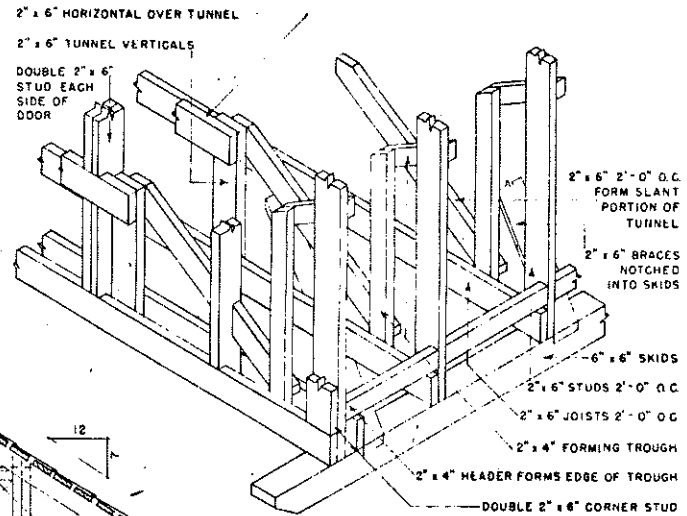

FRAMING DETAIL

NOT TO SCALE

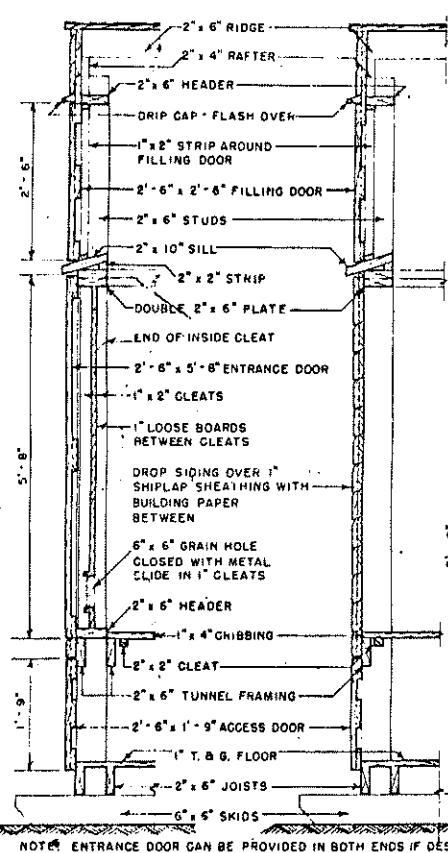

SECTIONS THROUGH ENDS

SCALE - 1/2" = 1'-0"

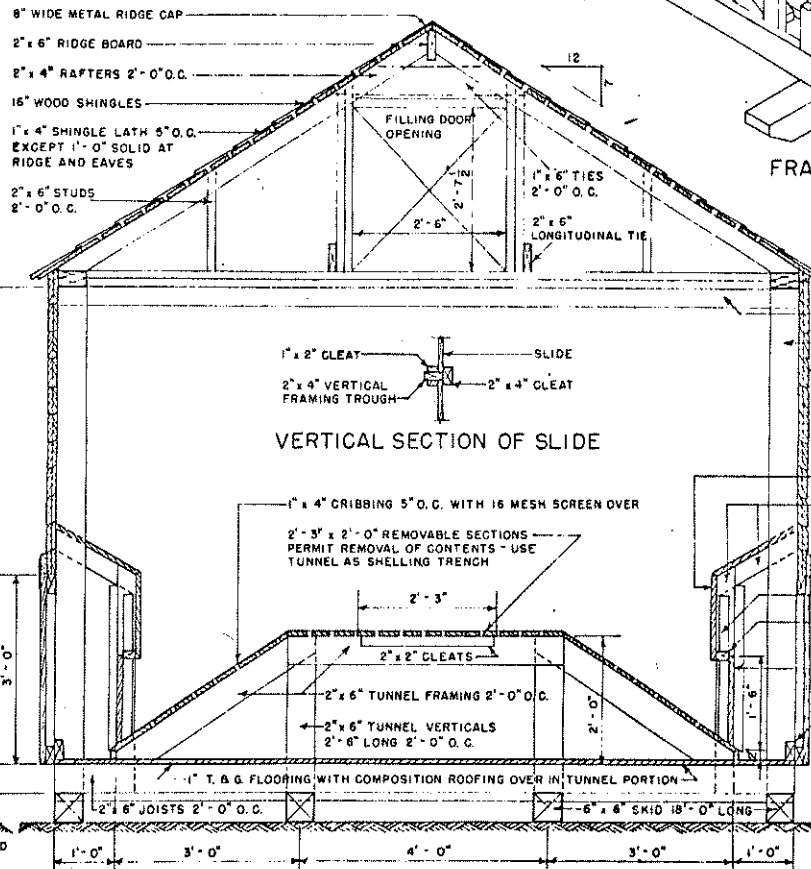

VERTICAL SECTION OF SLIDE

CROSS SECTION

SCALE - 1/2" = 1'-0"

COOPERATIVE EXTENSION WORK IN AGRICULTURE AND HOME ECONOMICS

AND UNITED STATES DEPARTMENT OF AGRICULTURE COOPERATING

MOVABLE HOG FEEDER STORAGE & DRIER, GRAIN & EAR CORN

M.W. EX. 5725 SHEET 2 OF 2

26  
ceap