

Louvers, 2'-0" x 3'-0"  
 3'-2" x 4'-3" double  
 a.m. butterfly  
 damper on 1/4"  
 pipe axle with  
 chain controls

3/8" holes in plate  
 between studs,  
 24" o.c.

**WIRING SYMBOLS**

- Bracket light
- Bracket light (pull switch)
- Drop light
- ⊕ Double convenience outlet
- ⊖ wall switch

Variable-sized  
 wall-floor duct,  
 See plan and  
 details on  
 sheet 2

Earth banked around  
 all but track side.  
 If banking is omitted,  
 insulate walls as  
 shown on sheet 2 of 5

**LONGITUDINAL SECTION B-B**  
 SCALE 1/4" = 1'-0"

COOPERATIVE EXTENSION WORK IN  
 AGRICULTURE AND HOME ECONOMICS  
 STATE OF NORTH DAKOTA  
 NORTH DAKOTA AGRICULTURAL COLLEGE  
 UNITED STATES DEPARTMENT OF AGRICULTURE COOPERATING

**MAINE TRACKSIDE POTATO STORAGE**  
 10,000 BARREL CAPACITY

USDA '47 EX. 5647 SHEET 3 OF 5

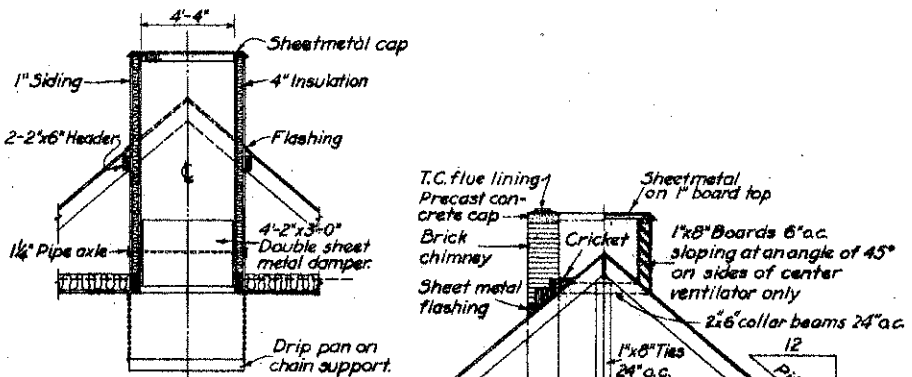

**DETAIL OF END VENTILATORS**  
 Note: For alternate ventilator details see sheet 5 of 5.

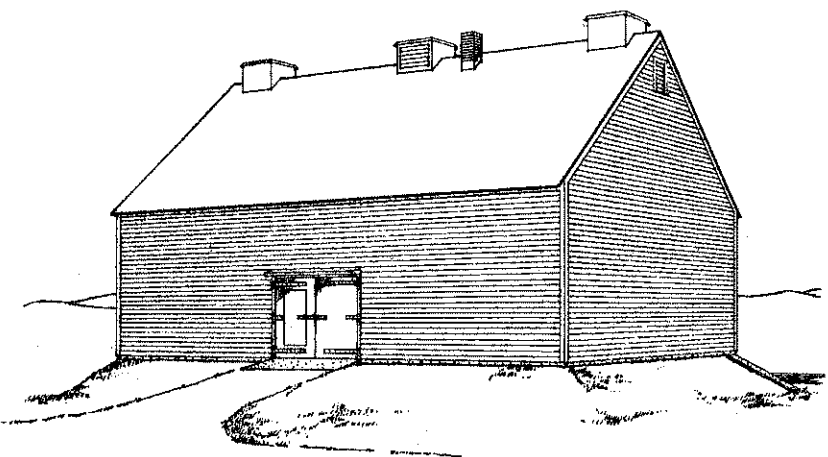

**PERSPECTIVE**

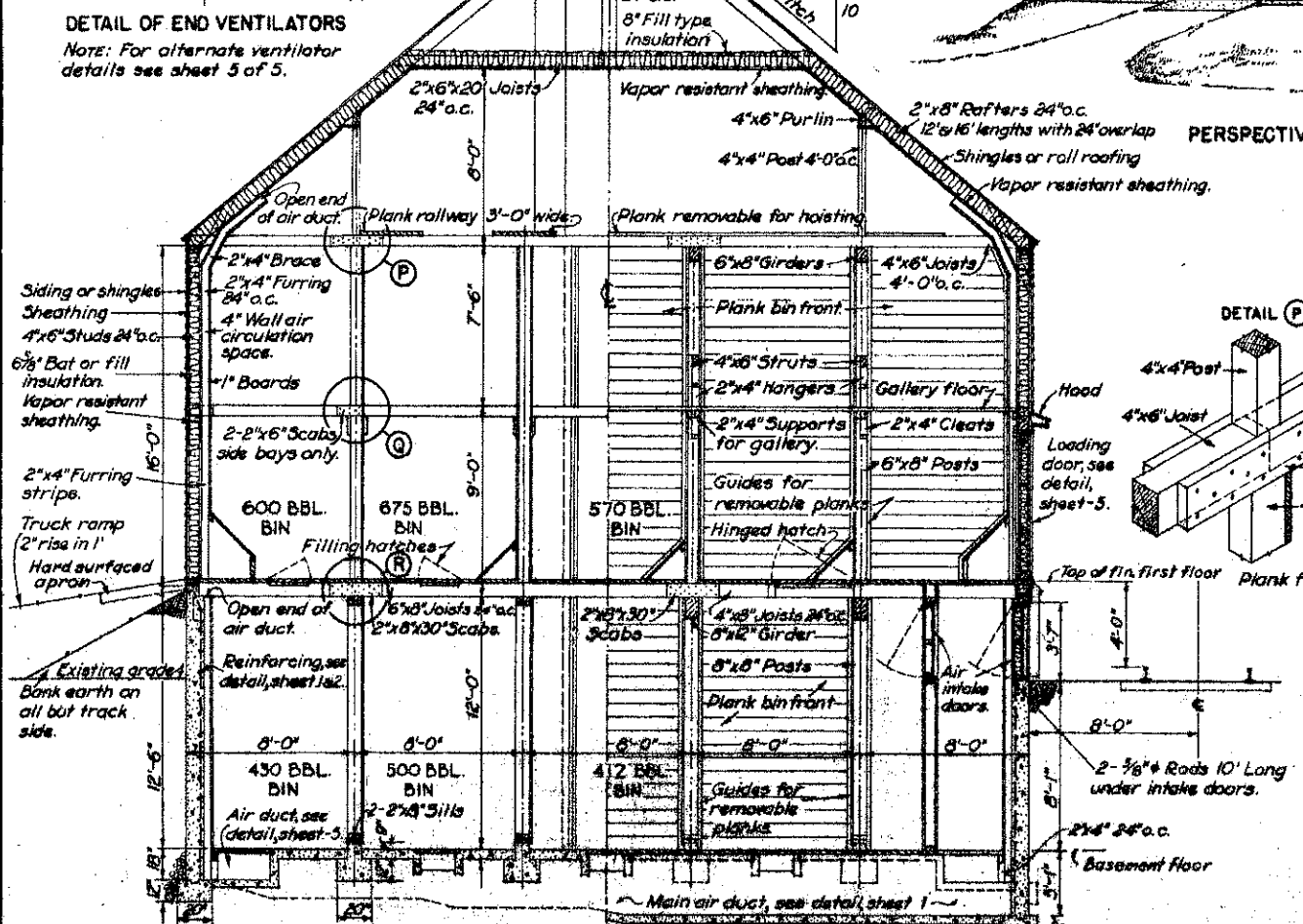

**CROSS SECTION A-A**  
 SCALE 1/2" = 1'-0"

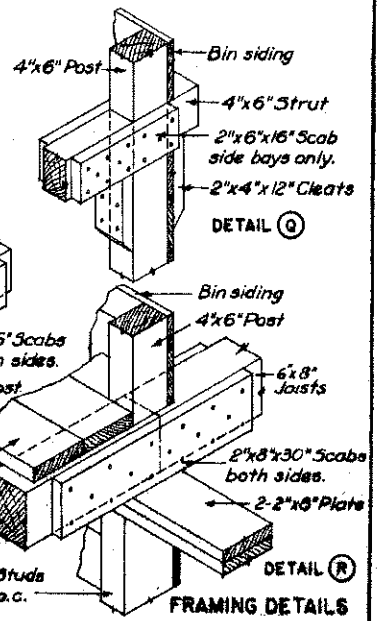

**FRAMING DETAILS**

COOPERATIVE EXTENSION WORK IN  
 AGRICULTURE AND HOME ECONOMICS  
 STATE OF NORTH DAKOTA  
 NORTH DAKOTA AGRICULTURAL COLLEGE  
 UNITED STATES DEPARTMENT OF AGRICULTURE, COOPERATING  
**MAINE TRACKSIDE POTATO STORAGE**  
 10,000 BARREL CAPACITY  
 USDA '37 BUL. 8547 SHEET 4 OF 5

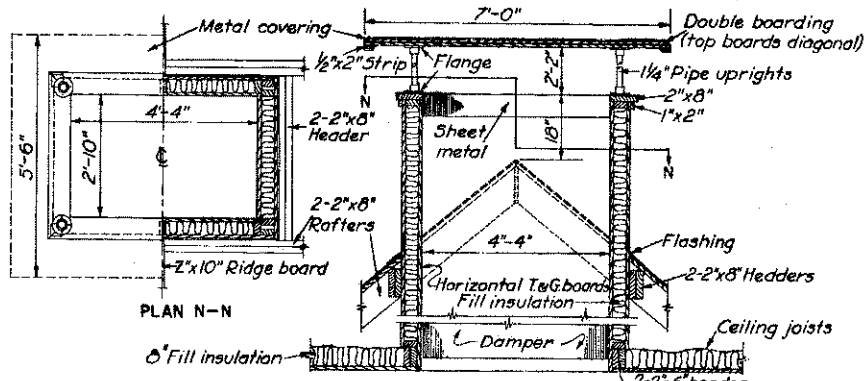

PLAN N-N

SECTION THRU VENTILATOR

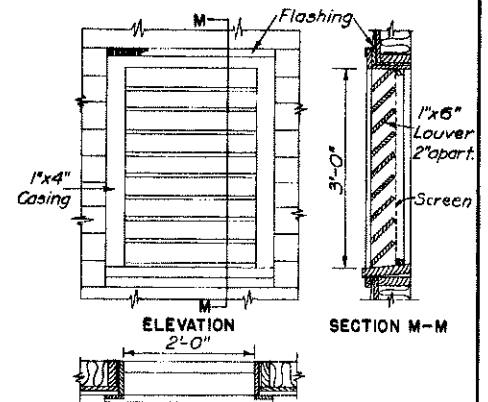

PLAN LOUVER DETAILS

SCALE 3/4" = 1'-0"

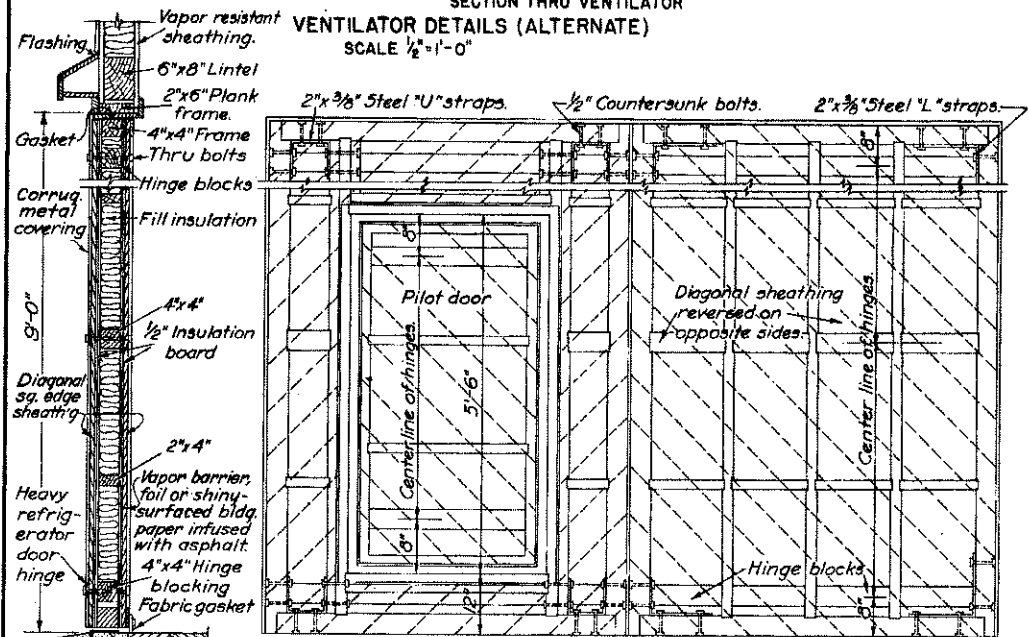

VENTILATOR DETAILS (ALTERNATE)  
SCALE 1/2" = 1'-0"

ELEVATION OF DOOR FRAMING

Note: Dimensions for doors are for clear openings. When constructing driveway doors allow 1/2" clearance on all four sides & between doors, and 1/4" clearance on four sides at pilot door. Loading doors should have 1/4" clearance at jambs & between doors, and 1/2" clearance at head and sill. Clearances allow for swelling.

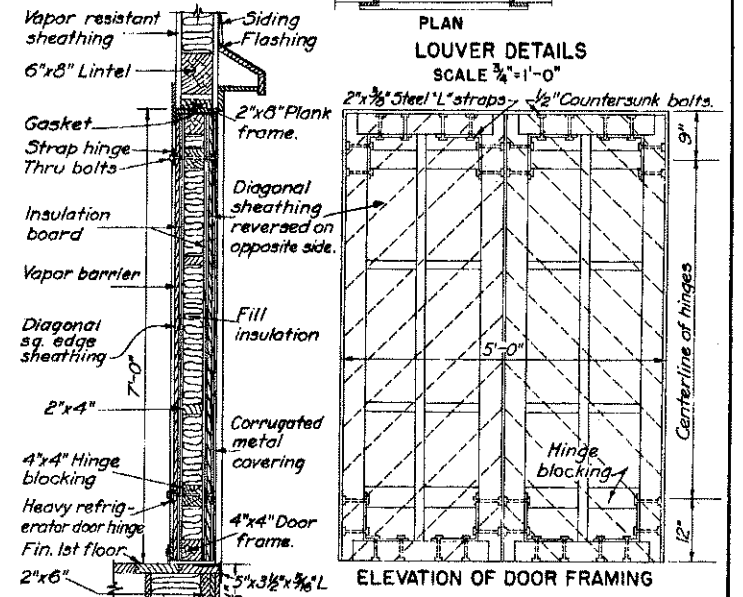

ELEVATION OF DOOR FRAMING

SCALE 3/4" = 1'-0"

PLAN OF LOADING DOORS

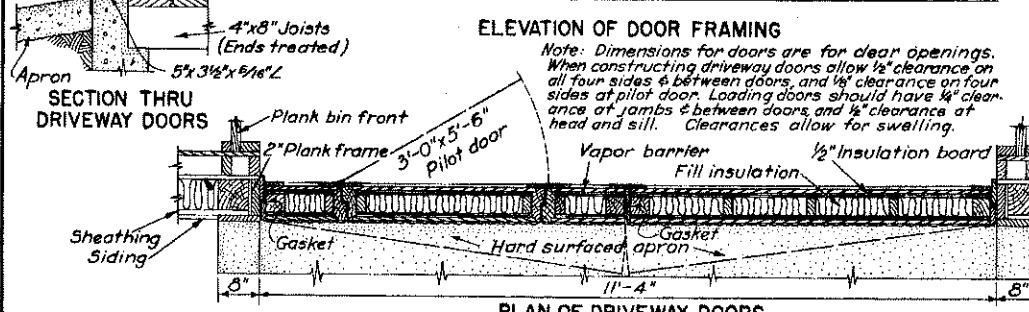

SECTION THRU DRIVEWAY DOORS

PLAN OF DRIVEWAY DOORS  
SCALE 3/4" = 1'-0"

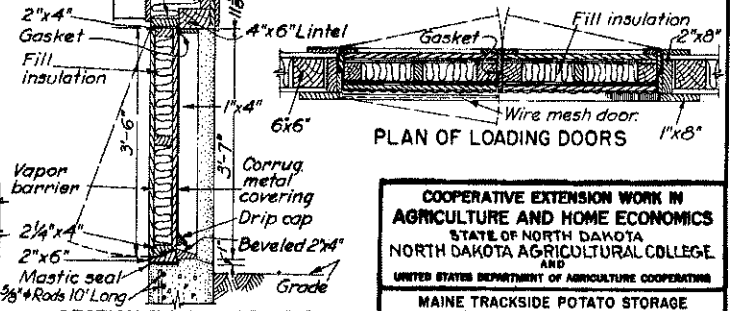

SECTION THRU LOADING & INTAKE DOORS ON TRACKSIDE  
SCALE 3/4" = 1'-0"

COOPERATIVE EXTENSION WORK IN AGRICULTURE AND HOME ECONOMICS  
STATE OF NORTH DAKOTA  
NORTH DAKOTA AGRICULTURAL COLLEGE  
AND  
UNITED STATES DEPARTMENT OF AGRICULTURE COOPERATING

MAINE TRACKSIDE POTATO STORAGE  
10,000 BARREL CAPACITY

USDA '47 EX. 5647 SHEET 5 OF 5