

ELEVATIONS  
SCALE  $\frac{1}{8}'' = 1'-0''$

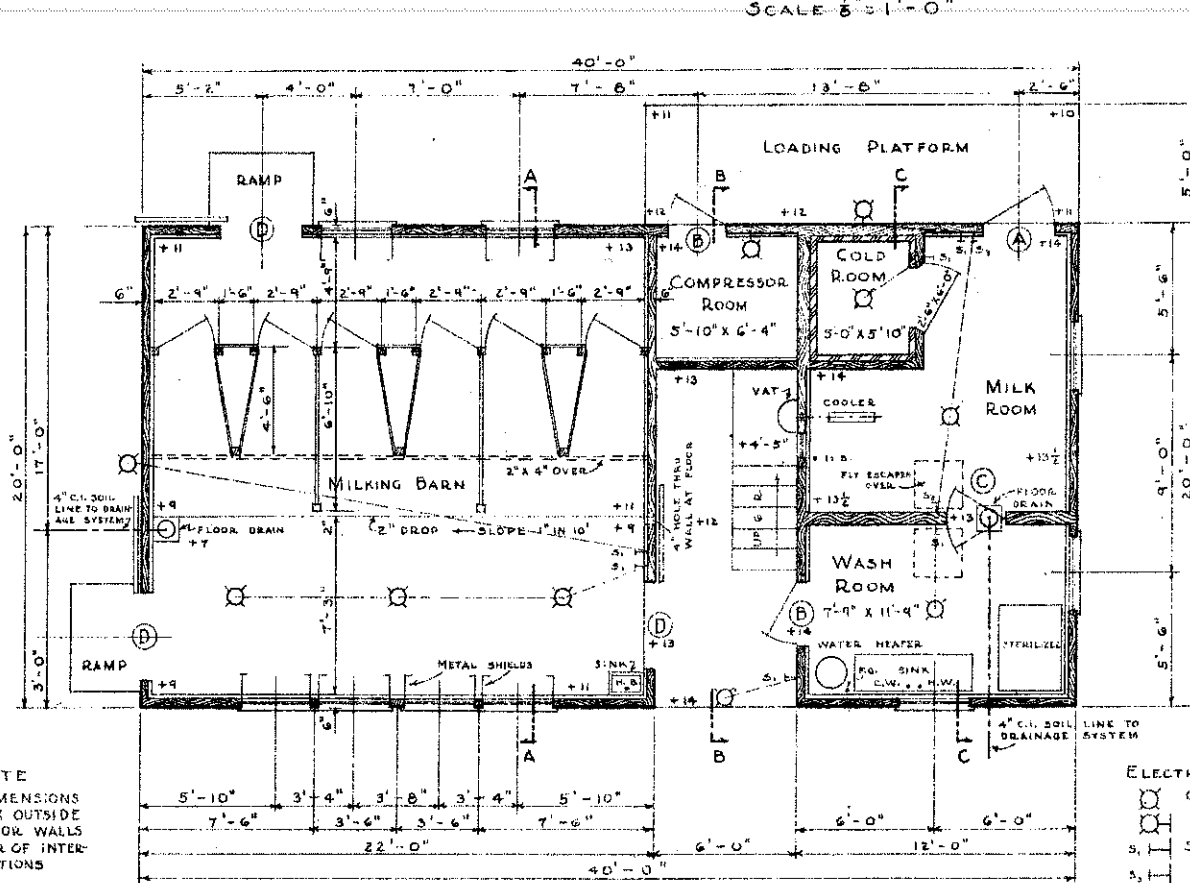

FLOOR PLAN  
SCALE  $\frac{1}{4}'' = 1'-0''$

NOTE  
ROOM DIMENSIONS  
ARE FROM OUTSIDE  
OF EXTERIOR WALLS  
TO CENTER OF INTER-  
IOR PARTITIONS

- ELECTRICAL SYMBOLS
- CEILING OUTLET
  - WALL BRACKET
  - SINGLE POLE SWITCH
  - 3-WAY SWITCH
- GENERAL SYMBOLS
- H.B. • HOSE BIBBS, COLD WATER
  - C.W. • COLD WATER
  - H.W. • HOT WATER
  - F.G. • FUEL GAS

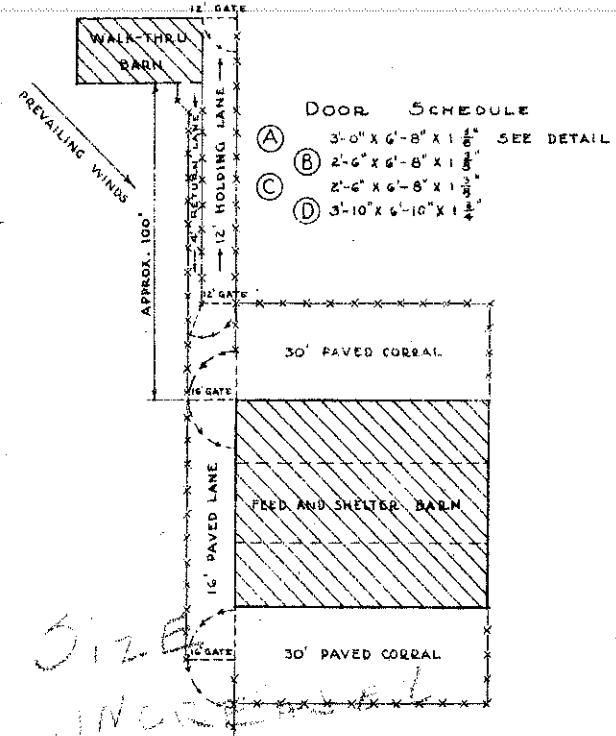

PLOT PLAN  
SCALE 1" = 30'

ADAPTED FROM UNIVER-  
SITY OF CALIFORNIA PLAN

COOPERATIVE EXTENSION WORK IN  
AGRICULTURE AND HOME ECONOMICS  
STATE OF NORTH DAKOTA  
NORTH DAKOTA AGRICULTURAL COLLEGE  
AND  
DEPT. OF AGRICULTURE COOPERATING  
EXT. AGR'L. ENGINEER - FARGO, N. DAK.

WALK THROUGH MILKING BARN.  
MIDWEST 15221-33 EX. 5369 SHEET 1 OF 4

SECTION A-A  
SCALE  $\frac{3}{8}'' = 1'-0''$

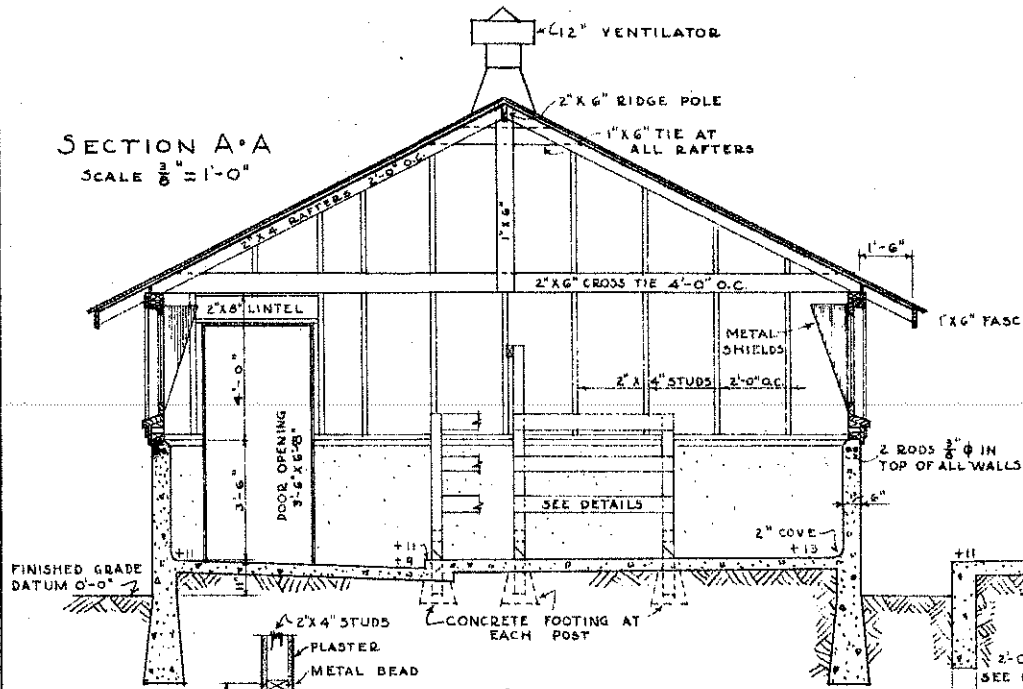

SECTION B-B  
SCALE  $\frac{3}{8}'' = 1'-0''$

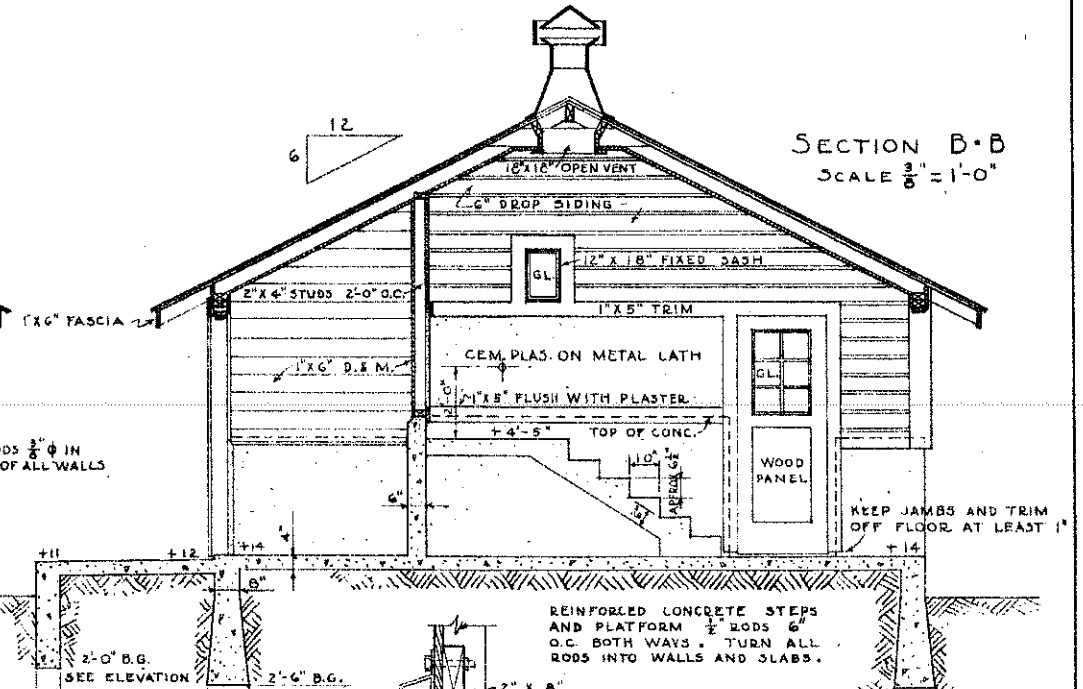

WALL BETWEEN WASH AND MILK ROOMS  
SCALE  $\frac{3}{4}'' = 1'-0''$

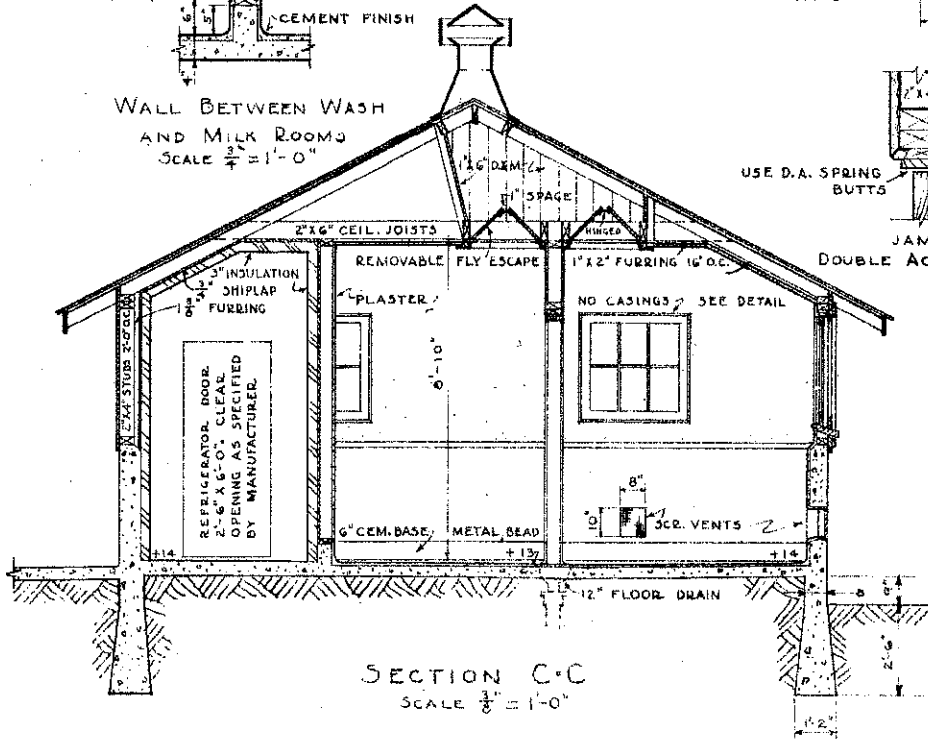

SECTION C-C  
SCALE  $\frac{3}{8}'' = 1'-0''$

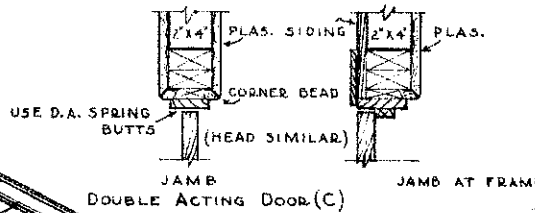

EXTERIOR DOOR FRAME, SLIDING DOOR FRAME (DOORS A & B) SCALE  $1\frac{1}{2}'' = 1'-0''$  (DOOR D)

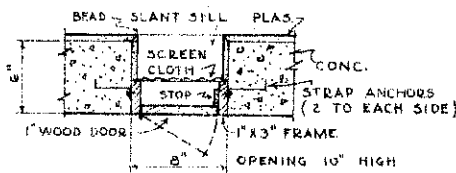
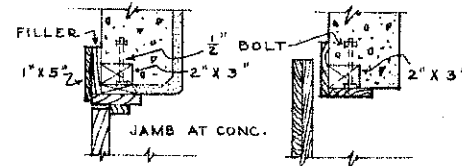

DETAIL OF SCREENED VENTS  
SCALE  $1\frac{1}{2}'' = 1'-0''$

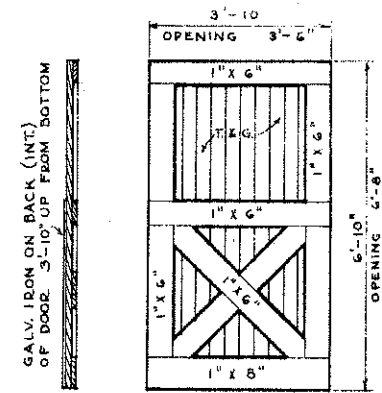

DETAIL OF SLIDING DOOR  
SCALE  $\frac{1}{2}'' = 1'-0''$

COOPERATIVE EXTENSION WORK IN  
 AGRICULTURE AND HOME ECONOMICS  
 STATE OF NORTH DAKOTA  
 NORTH DAKOTA AGRICULTURAL COLLEGE  
 AND  
 U. S. DEPT. OF AGRICULTURE COOPERATING  
 EXT. AGR'L ENGINEER - FARGO, N. DAK.

WALK THROUGH MILKING BARN.  
 MIDWEST 75221-33 EX. 5370 SHEET 2 OF 4

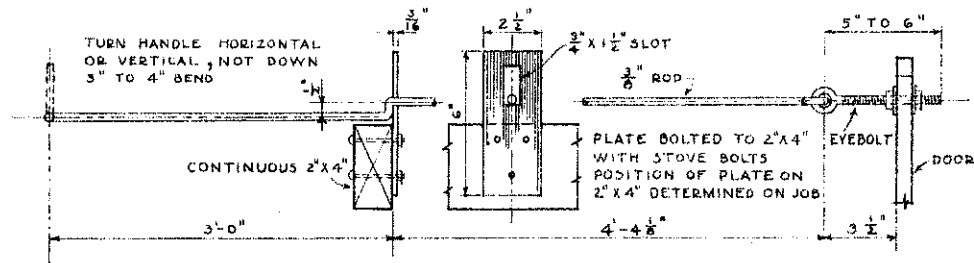

DOOR OPERATING LEVER  
SCALE 3" = 1'-0"

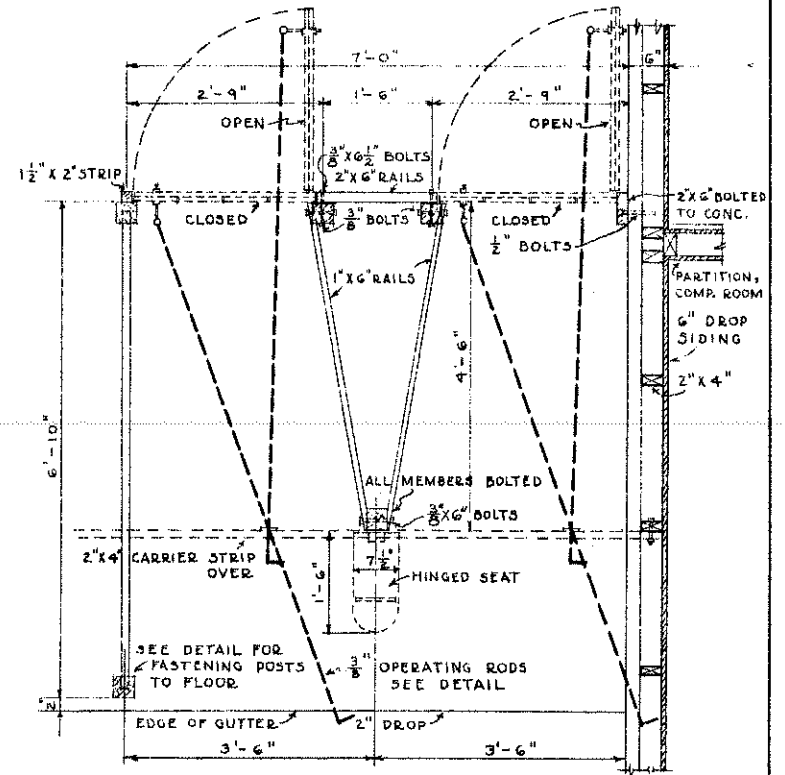

PLAN OF TWO STALLS  
SCALE 3/4" = 1'-0"

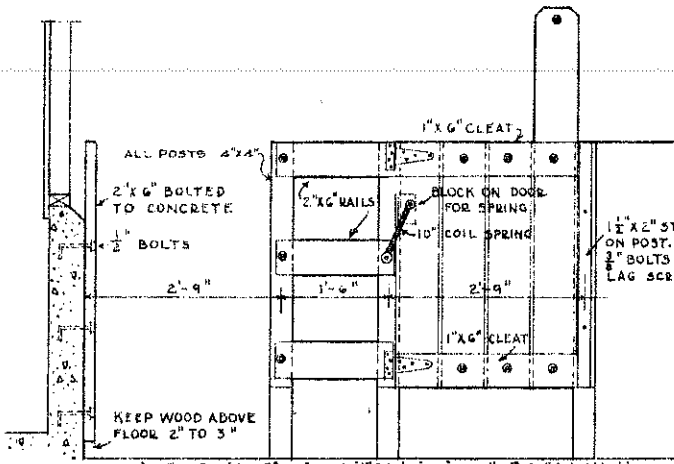

ELEVATION OF GATES FROM EXIT ALLEY

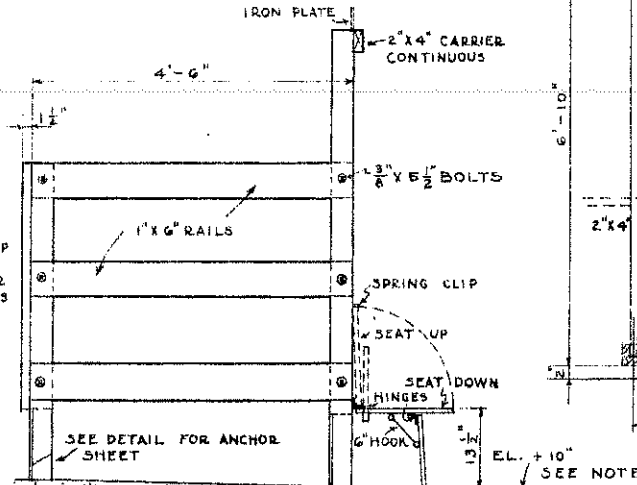

ELEVATION, CENTER PARTITIONS

SCALE 3/4" = 1'-0"

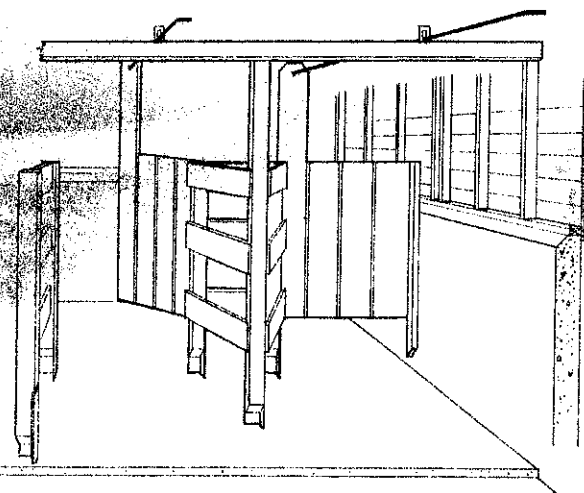

PERSPECTIVE LOOKING TOWARD GATES

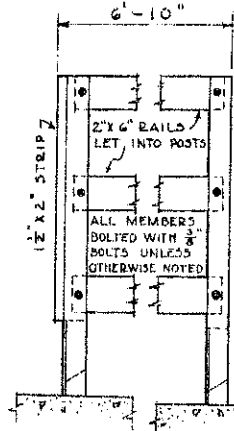

LONG PARTITIONS

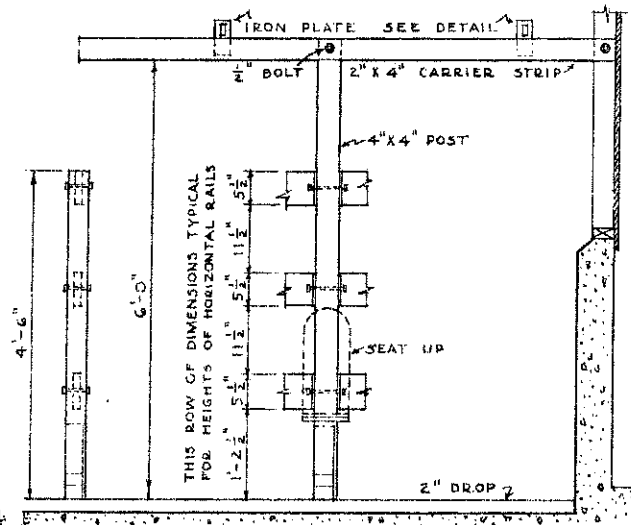

FRONT ELEVATION

SCALE 3/4" = 1'-0"

NOTE FOR ELEVATION +10"  
VERTICAL DIMENSIONS, INDICATED RELATIVE TO ELEVATION +10", WILL ACTUALLY VARY DUE TO SLOPE OF FLOOR. THIS VARIATION SHOULD BE TAKEN UP IN THE FIRST VERTICAL DIVISION OF THE STALLS (SEE FRONT ELEVATION, LEFT - 1'-2 1/2")

COOPERATIVE EXTENSION WORK IN  
AGRICULTURE AND HOME ECONOMICS  
STATE OF NORTH DAKOTA  
NORTH DAKOTA AGRICULTURAL COLLEGE  
AND  
U. S. DEPT. OF AGRICULTURE COOPERATING  
EXT. AGR'L ENGINEER- FARGO, N. DAK.

WALK THROUGH MILKING BARN

MIDWEST 7522/33 EX 537 SHEET 3 OF 4

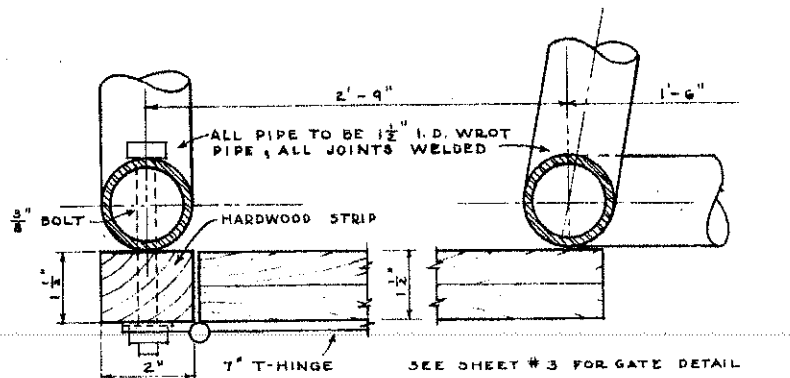

METHOD OF SWINGING GATES TO PIPE PARTITIONS  
SCALE 1/2" = 1'-0"

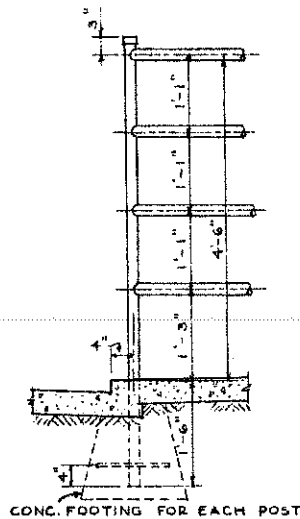

ALTERNATE DETAIL - PIPE PARTITIONS  
SCALE 3/4" = 1'-0"

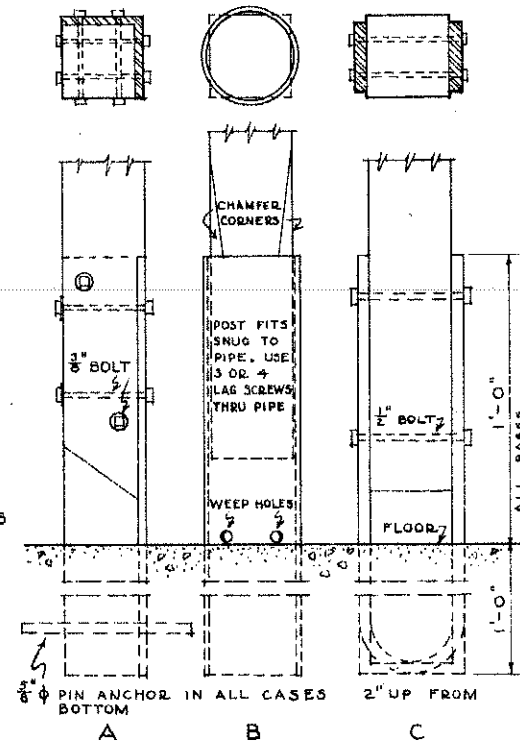

FLOOR ANCHORS FOR 4"x4" WOOD POSTS  
SCALE 3" = 1'-0"

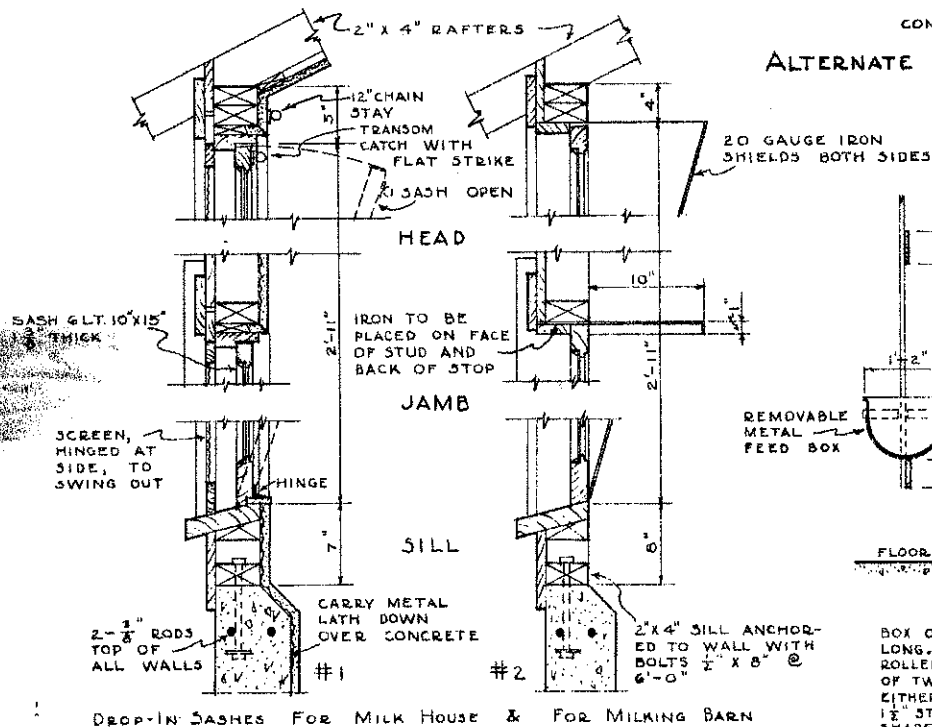

TYPICAL WINDOW DETAILS  
SCALE 1 1/2" = 1'-0"

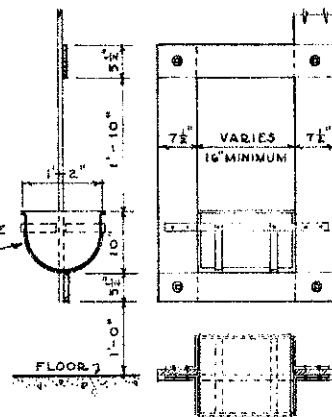

ALTERNATE DOOR DETAIL  
SCALE 3/4" = 1'-0"

COOPERATIVE EXTENSION WORK IN  
AGRICULTURE AND HOME ECONOMICS  
STATE OF NORTH DAKOTA  
NORTH DAKOTA AGRICULTURAL COLLEGE  
AND  
U. S. DEPT. OF AGRICULTURE COOPERATING  
EXT. AGR'L. ENGINEER - FARGO, N. DAK.

WALK THROUGH MILKING BARN.  
MIDWEST 7522:33 EX. 5372 SHEET 4 OF 4