

END ELEVATION - PIT END

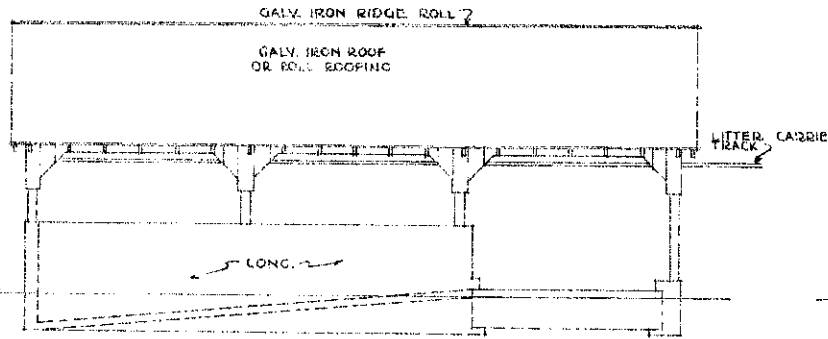

SIDE ELEVATION
SCALE OF ELEVATIONS 1/16" = 1'-0"

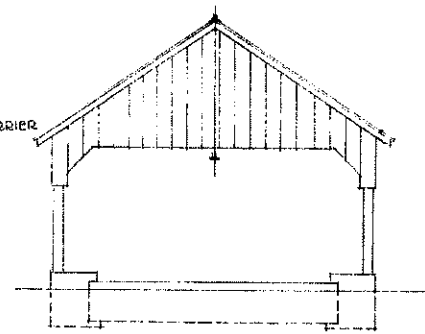

END ELEVATION - DRIVEWAY END

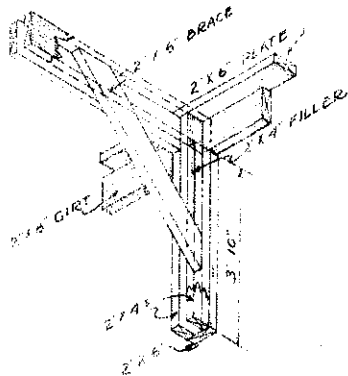

ISOMETRIC VIEW OF POST CONSTRUCTION

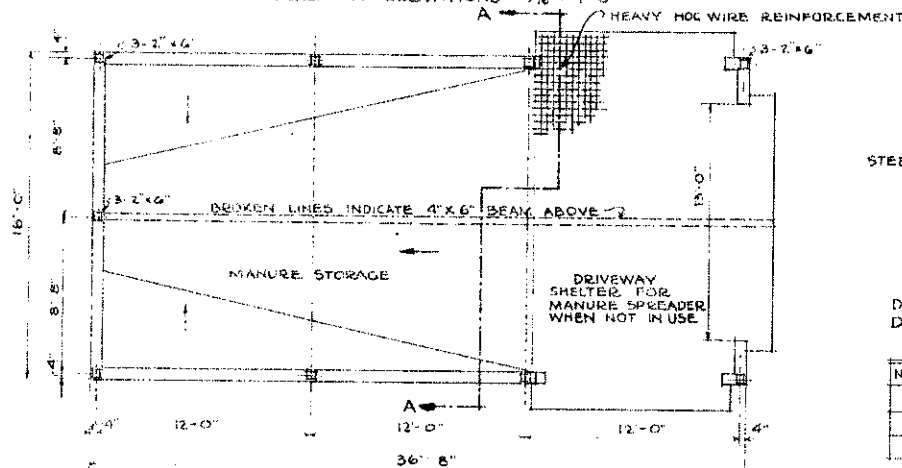

PLAN
SCALE 1/16" = 1'-0"

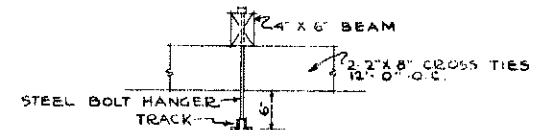

DETAIL SHOWING TRACK AND SUPPORTS
SCALE 1/4" = 1'-0"

DIMENSIONS OF MANURE PITS FOR DAIRY HERDS OF VARIOUS SIZES EXCLUSIVE OF DRIVEWAY

NO. OF COWS	LENGTH	WIDTH	AV. DEPTH
10	16'-4"	16'-0"	4'-0"
18	24'-4"	18'-0"	4'-0"
20	26'-4"	18'-0"	4'-0"

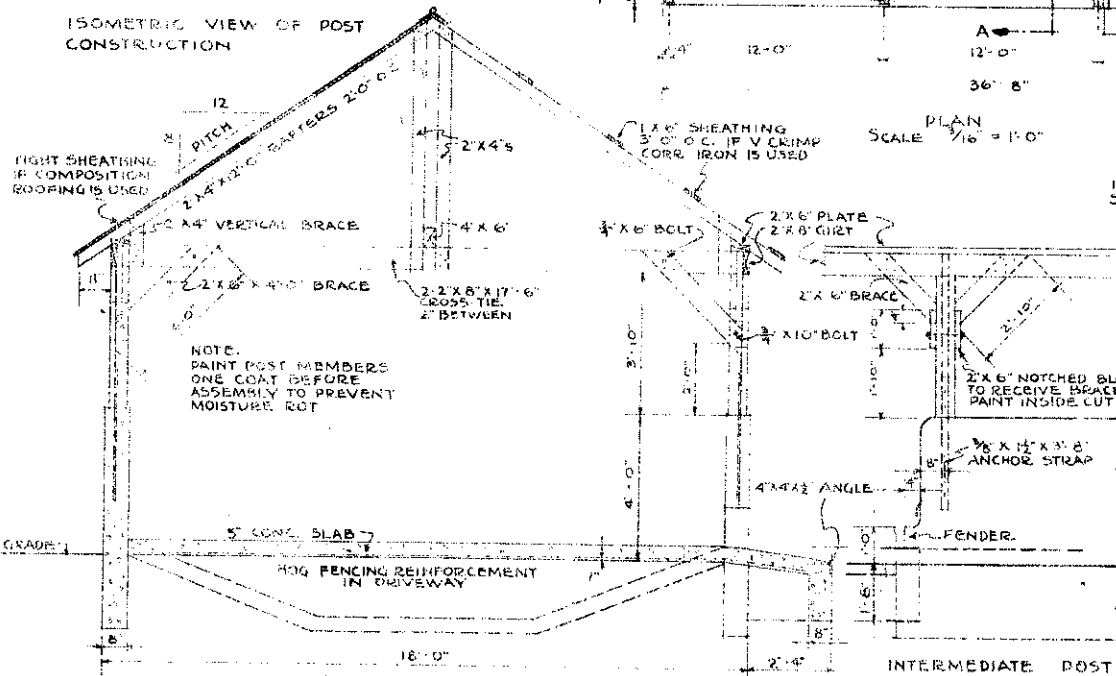

ROOF FRAMING SECT. A-A
SCALE 3/8" = 1'-0"

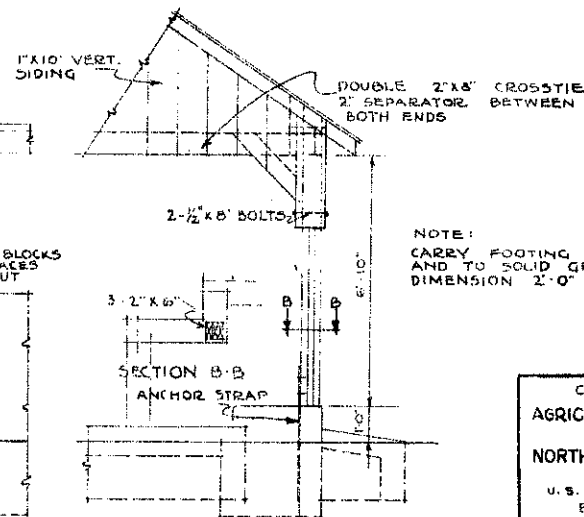

CORNER POST
DETAIL OF BRACING
SCALE 3/8" = 1'-0"

NOTE:
CARRY FOOTING BELOW FROST LINE AND TO SOLID GROUND, APPROXIMATE DIMENSION 2'-0" TO 2'-6"

COOPERATIVE EXTENSION WORK IN
AGRICULTURE AND HOME ECONOMICS
STATE OF NORTH DAKOTA
NORTH DAKOTA AGRICULTURAL COLLEGE
AND
U.S. DEPT. OF AGRICULTURE COOPERATING
EXT. AGRI. ENGINEER - FARGO, N. DAK.
CONCRETE MANURE PIT.
MIDWEST 74301-33 EX 5347 SHEET 1 OF 1