

WEST ELEVATION
SCALE $\frac{1}{8}'' = 1'-0''$

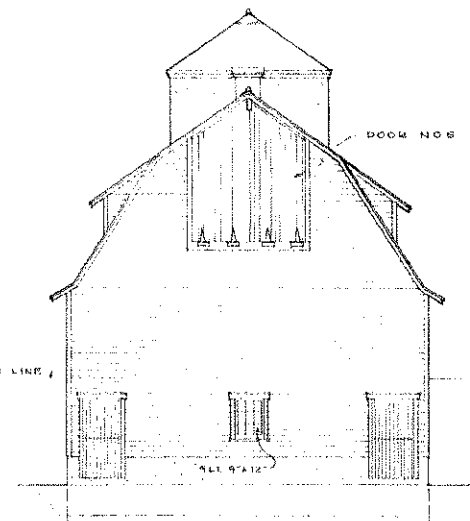

SOUTH ELEVATION
SCALE $\frac{1}{8}'' = 1'-0''$

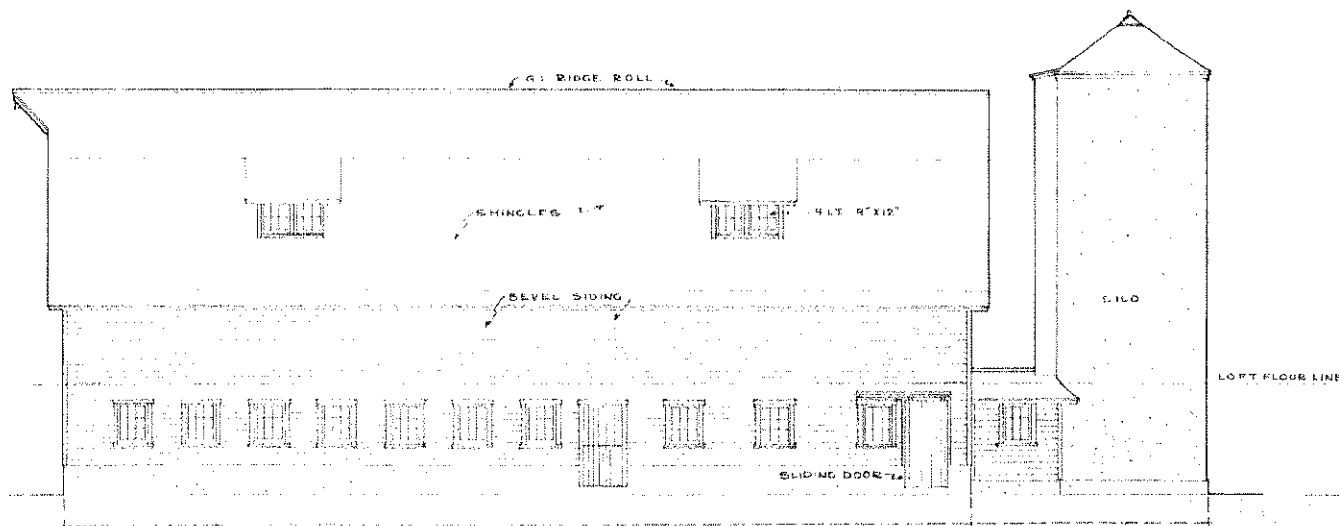

EAST ELEVATION
SCALE $\frac{1}{8}'' = 1'-0''$

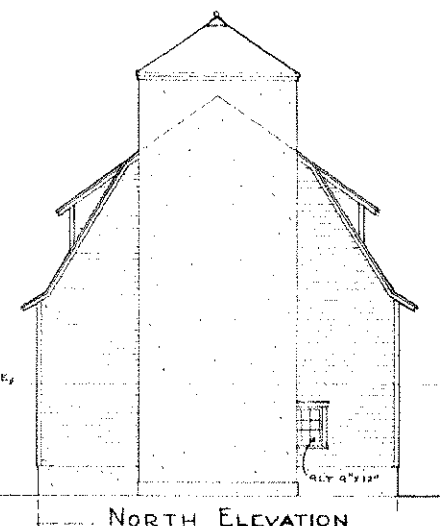

NORTH ELEVATION

COOPERATIVE EXTENSION WORK IN
AGRICULTURE AND HOME ECONOMICS
STATE OF NORTH DAKOTA
NORTH DAKOTA AGRICULTURAL COLLEGE
AND
U. S. DEPT. OF AGRICULTURE COOPERATING
EXT. AGR'L ENGINEER - FARGO, N. DAK.
DAIRY BARN
MIDWEST 72301-33 BX 5246 SHEET 1 OF 7

DAI

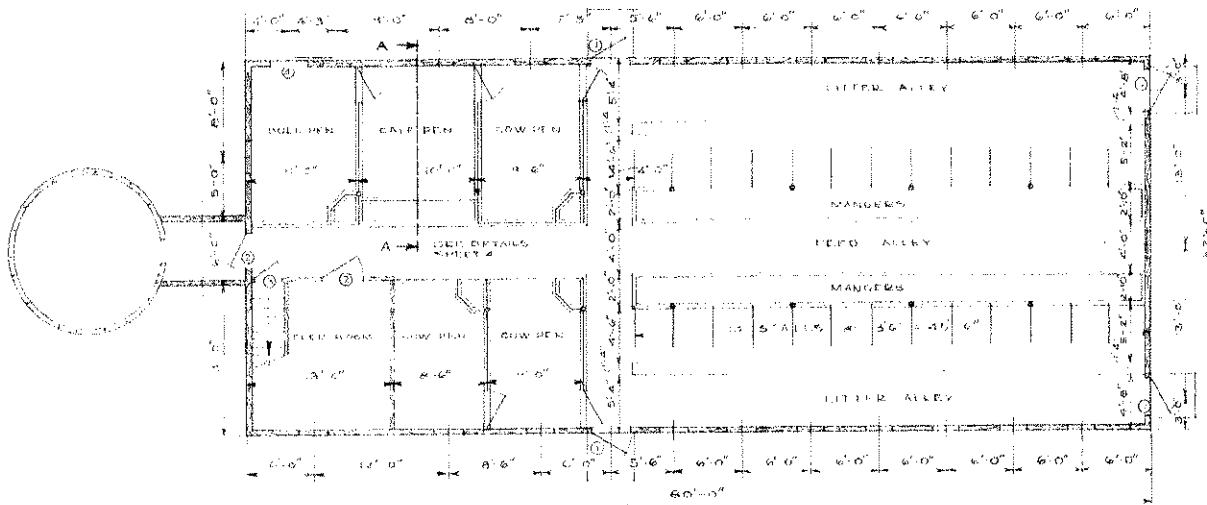

FLOOR PLAN
SCALE $\frac{1}{8}'' = 1'-0''$

DOOR SCHEDULE					
MK.	NO.	WIDE	HIGH	THK.	DESCRIPTION
1	4	3'-6"	7'-0"	$\frac{3}{4}$ "	CUT 3'-6" x 3'-6"
2	2	3'-6"	6'-6"	$\frac{3}{4}$ "	
3	1	2'-4"	6'-6"	$\frac{3}{4}$ "	
4	1	3'-9"	7'-4"	$\frac{3}{4}$ "	ROLLING DOOR
5	2	5'-3"	12'-0"	$\frac{1}{2}$ "	CABLE HAY DOOR

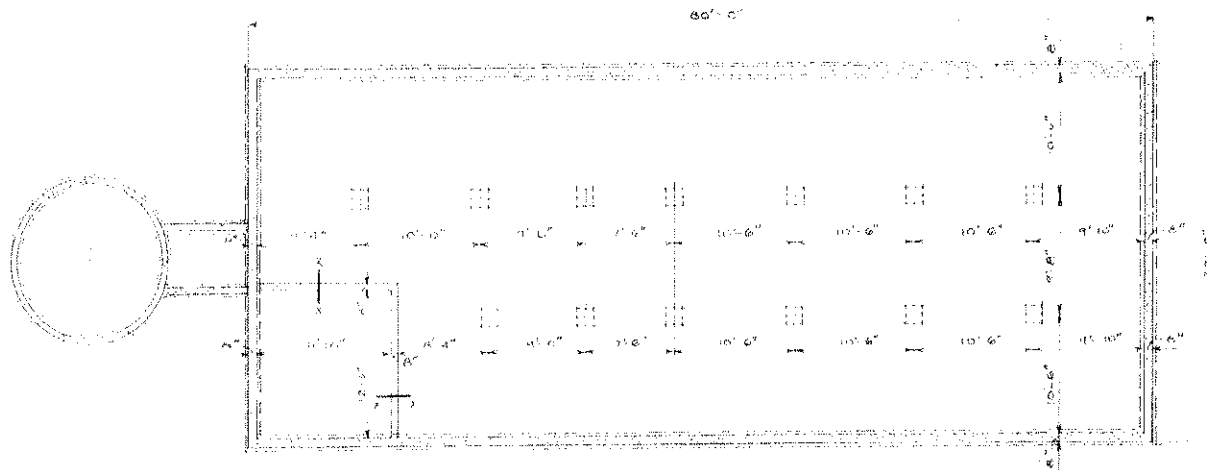
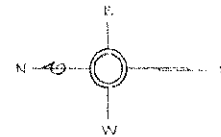

FOUNDATION PLAN
SCALE $\frac{1}{8}'' = 1'-0''$

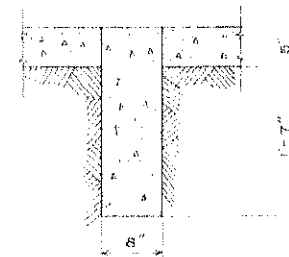

SECTION X-X
SCALE $1'' = 1'-0''$

COOPERATIVE EXTENSION WORK IN
AGRICULTURE AND HOME ECONOMICS
STATE OF NORTH DAKOTA
NORTH DAKOTA AGRICULTURAL COLLEGE
AND
U. S. DEPT. OF AGRICULTURE COOPERATING
EXT. AGR. ENGINEER- FARGO, N. DAK.
DAIRY BARN
MIDWEST 72301-33 EX. 5247 SHEET 2 of 7

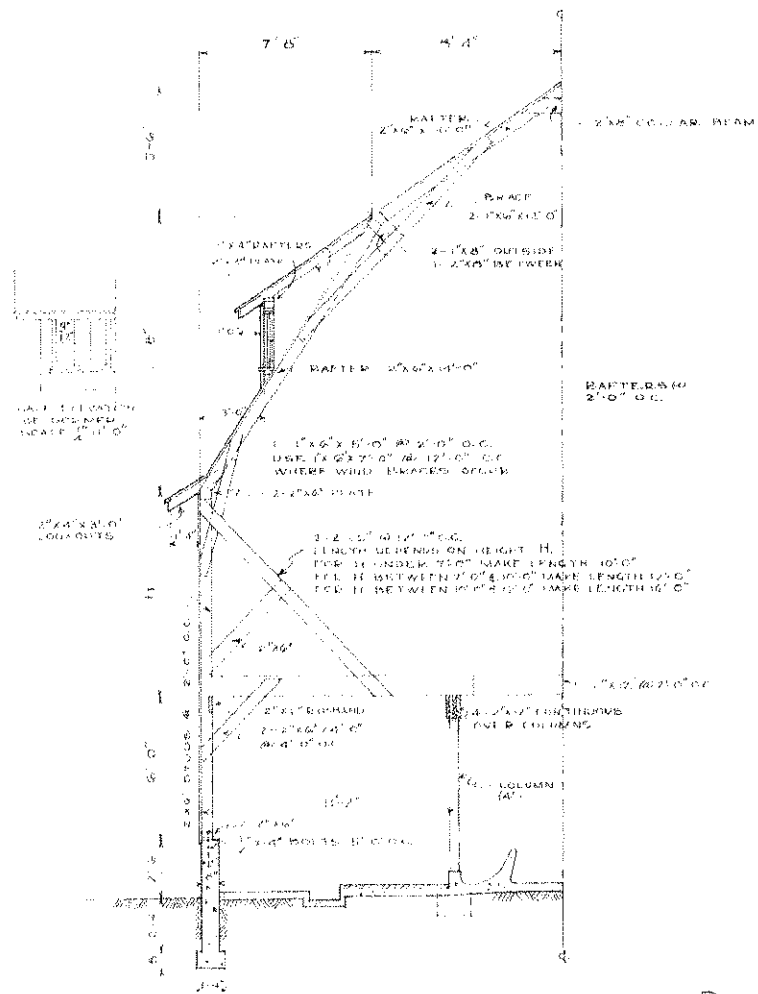

HALF CROSS SECTION
SYMMETRICAL ABOUT CENTER LINE
SCALE 1" = 4'-0"

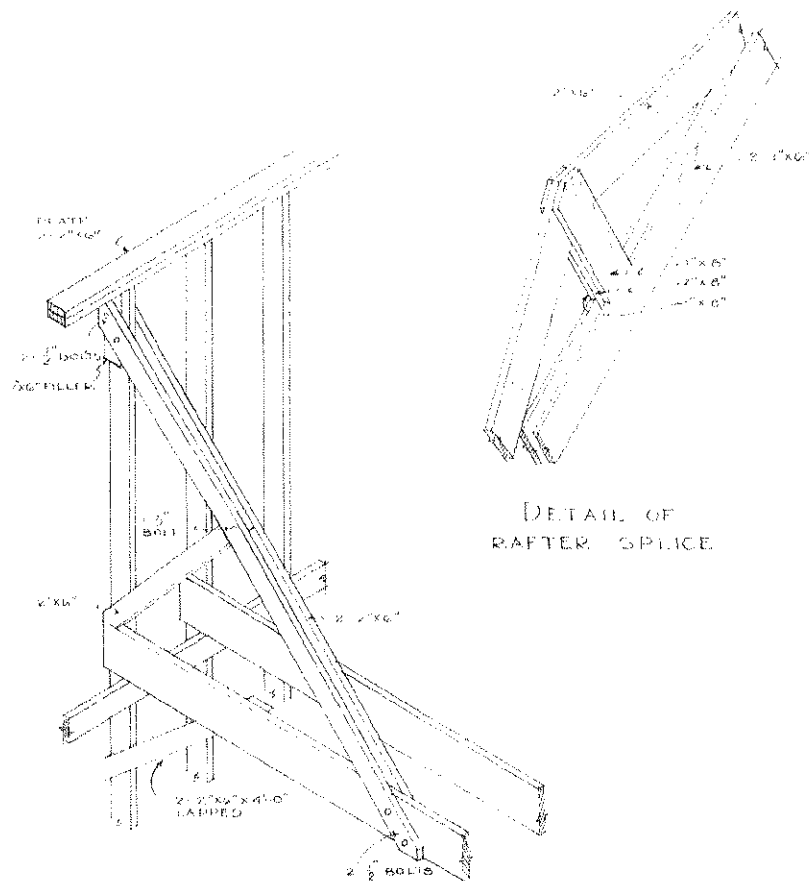

DETAIL OF WALL BRACE
TO BE SPACED 12'-0" O.C.

DETAILS OF ROOF FRAMING FOR
32'-0" DAIRY BARN

COOPERATIVE EXTENSION WORK IN
AGRICULTURE AND HOME ECONOMICS
STATE OF NORTH DAKOTA
NORTH DAKOTA AGRICULTURAL COLLEGE
AND
U. S. DEPT. OF AGRICULTURE COOPERATING
EXT. AGR'L ENGINEER - FARGO, N. DAK.
DAIRY BARN
MIDWEST 72301-33 EX. 524B SHEET 3 OF 7

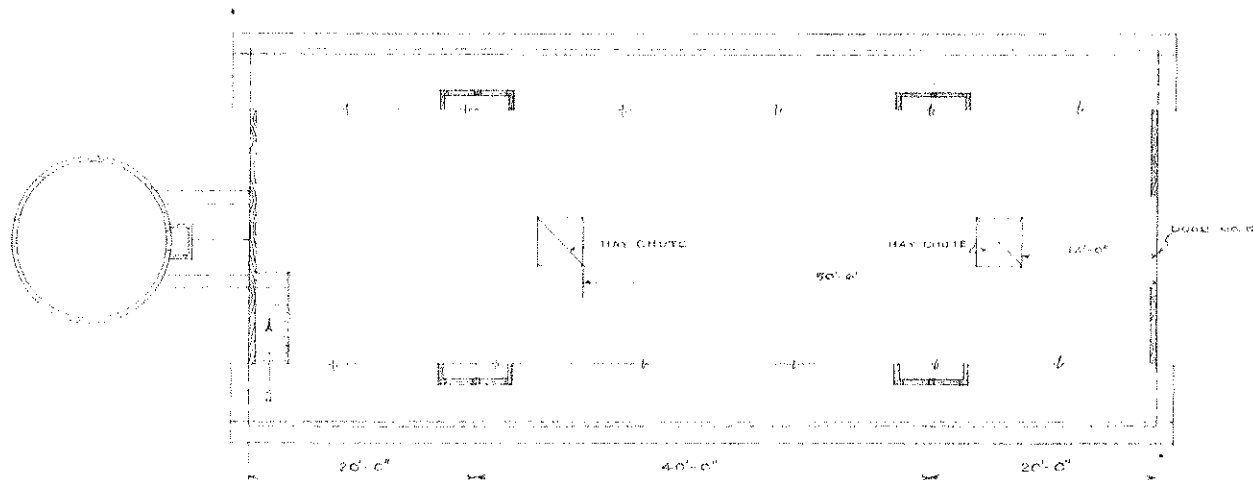

LOFT FLOOR PLAN
SCALE $\frac{1}{8}'' = 1'-0''$

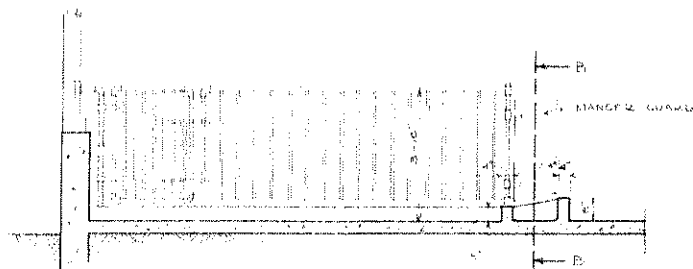

SECTION A-A
SCALE $\frac{3}{8}'' = 1'-0''$
SEE FLOOR PLAN SHEET 2

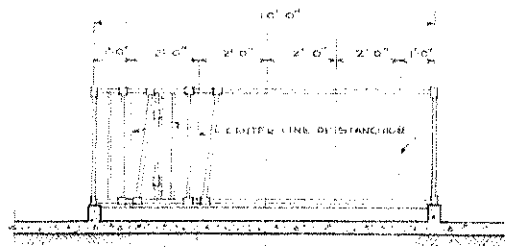

SECTION B-B
SCALE $\frac{3}{8}'' = 1'-0''$

DETAIL OF CALF PEN

COOPERATIVE EXTENSION WORK IN
AGRICULTURE AND HOME ECONOMICS
STATE OF NORTH DAKOTA
NORTH DAKOTA AGRICULTURAL COLLEGE
AND
U. S. DEPT. OF AGRICULTURE COOPERATING
EXT. AGR. ENGINEER-FARGO, N. DAK.

DAIRY BARN
MIDWEST 72301-33 EX. 5249 SHEET 4 OF 7

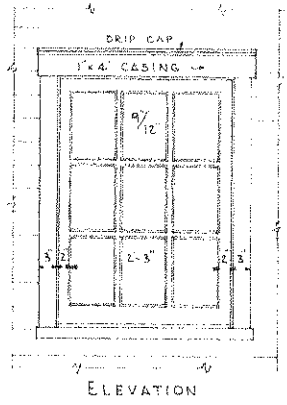

ELEVATION

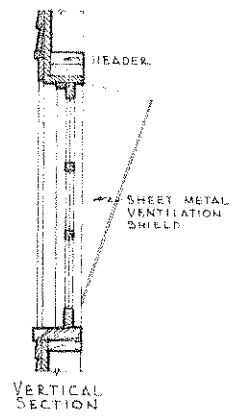

VERTICAL SECTION

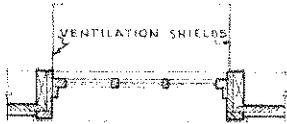

HORIZONTAL SECTION

TYPICAL WINDOW DETAILS
SCALE 3/4"=1'-0"

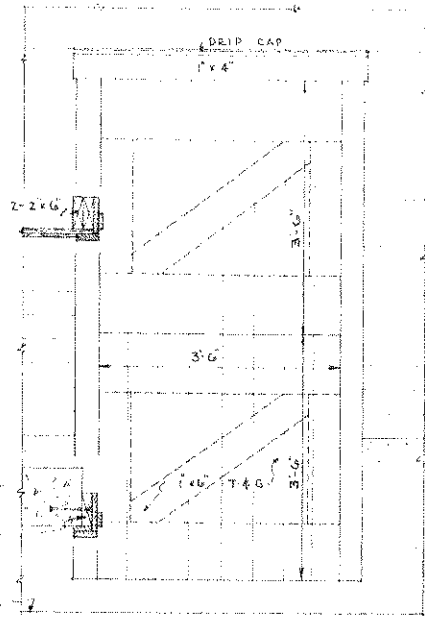

TYPICAL HINGED DOOR DETAILS
SCALE 3/4"=1'-0"

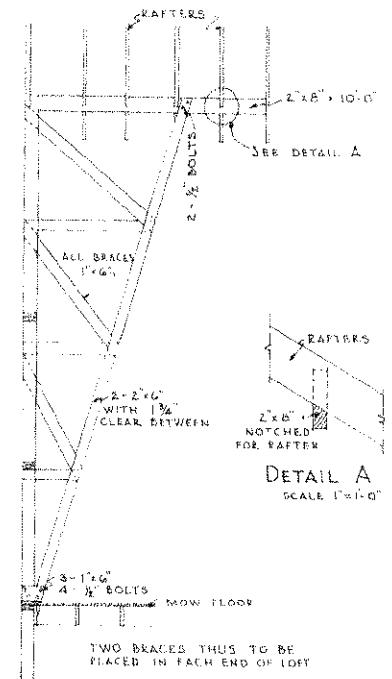
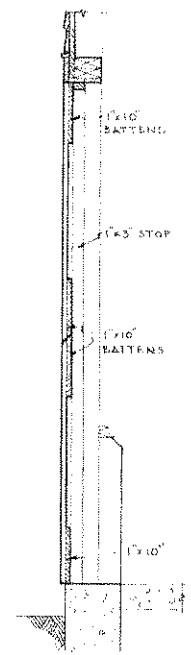

WIND BRACING FOR GABLE
SCALE 1/4"=1'-0"

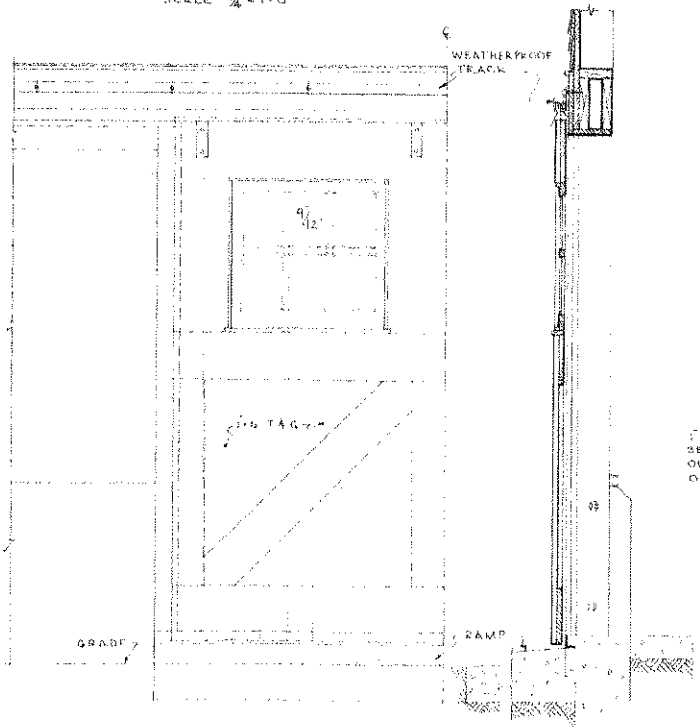

TYPICAL ROLLING DOOR DETAILS
SCALE 3/4"=1'-0"

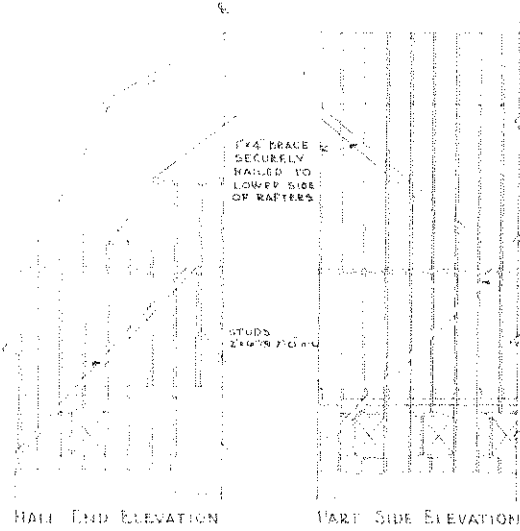

TYPICAL WALL FRAMING
SCALE 3/4"=1'-0"

COOPERATIVE EXTENSION WORK IN
 AGRICULTURE AND HOME ECONOMICS
 STATE OF NORTH DAKOTA
 NORTH DAKOTA AGRICULTURAL COLLEGE
 AND
 U. S. DEPT. OF AGRICULTURE COOPERATING
 EXT. AGR'L. ENGINEER—FARGO, N. DAK.

DAIRY BARN

MIDWEST 53
 72301-72351-72391 EX. 5250 SHEET 5077

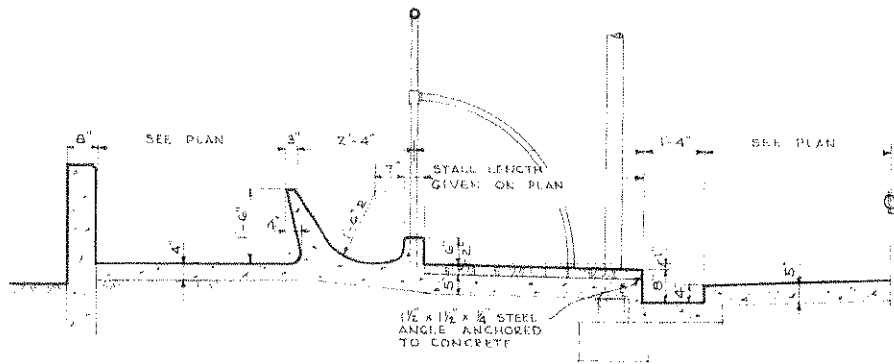

HALF SECTION THRU STALLS FOR FACE OUT ARRANGEMENT
SCALE: 1/2" = 1'-0"

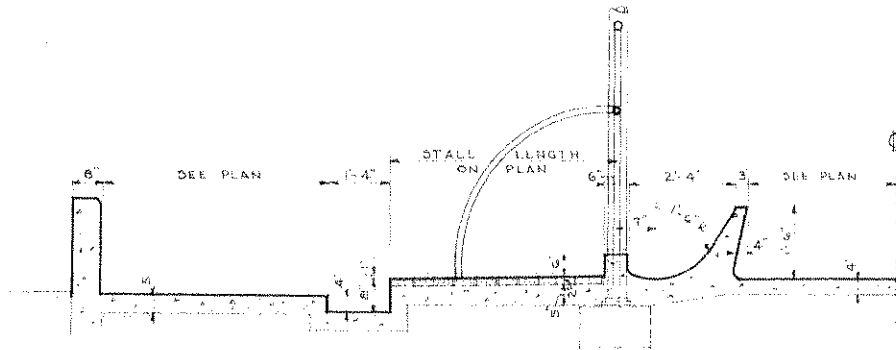

HALF SECTION THRU STALLS FOR FACE IN ARRANGEMENT
SCALE: 1/2" = 1'-0"

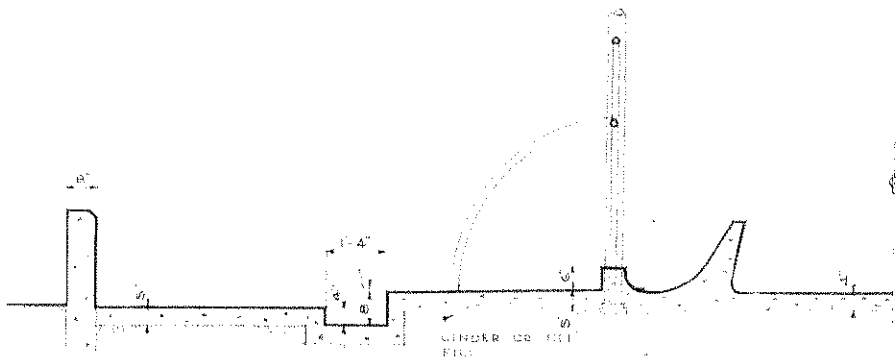

HALF SECTION SHOWING ALTERNATE FLOOR CONSTRUCTION
SCALE: 1/2" = 1'-0"

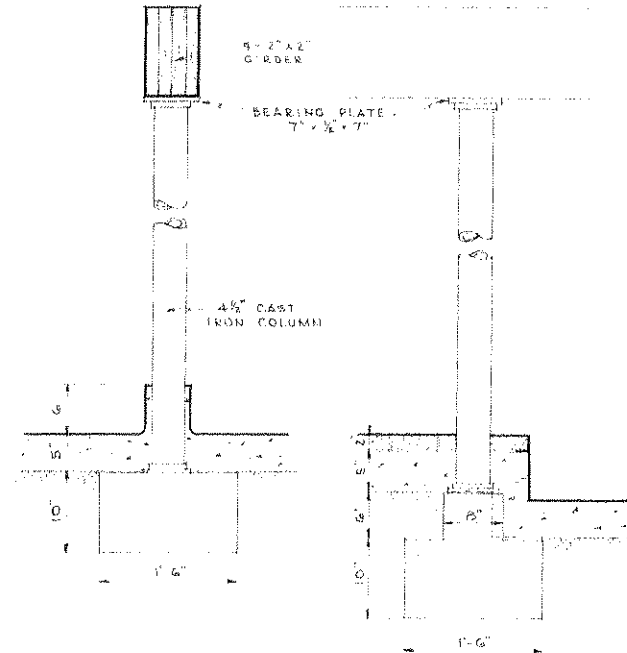

DETAIL FOR COLUMNS IN MANGER CURBS
DETAIL FOR COLUMNS AT GUTTERS

TYPICAL COLUMN DETAILS
SCALE: 1" = 1'-0"

COOPERATIVE EXTENSION WORK IN
AGRICULTURE AND HOME ECONOMICS
STATE OF NORTH DAKOTA
NORTH DAKOTA AGRICULTURAL COLLEGE
AND
U.S. DEPT. OF AGRICULTURE COOPERATING
EXT. AGRIC. ENGINEER—FARGO, N. DAK.

DAIRY BARN

MIDWEST 55
72301-72311-72321 E.X. 5259 SHEET 6 OF 7

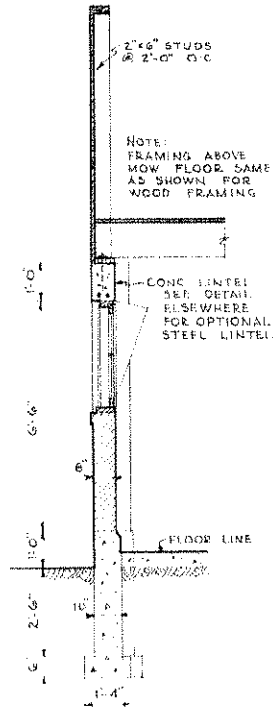

WALL SECTION
SCALE $\frac{3}{8}$ " = 1'-0"

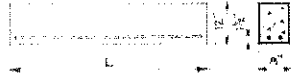

MAKE LENGTH "L" 10" MORE THAN WIDTH OF OPENING. REINFORCE WITH 2- $\frac{1}{2}$ " ϕ STEEL BARS PLACED AS SHOWN

CONCRETE LINTELS

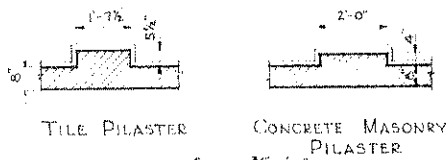

IN TILE AND CONCRETE MASONRY CONSTRUCTION PLACE PILASTERS ON INSIDE OF WALL SPACED @ 12'-0" O.C. MAKE FOUNDATION WALL ACCORDINGLY

PILASTER DETAILS
SCALE $\frac{3}{8}$ " = 1'-0"

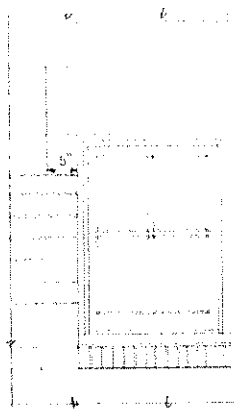

HALF ELEVATION



HORIZONTAL SECTION

TYPICAL WINDOW DETAILS
SCALE $\frac{3}{8}$ " = 1'-0"

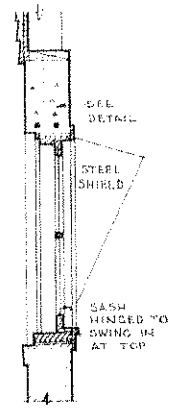

VERTICAL SECTION

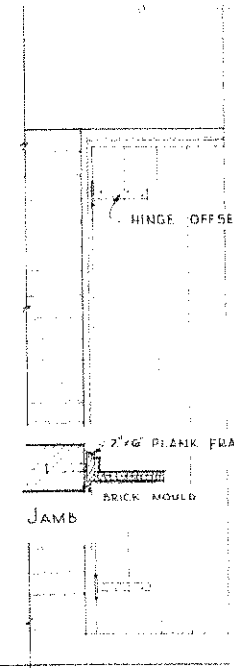

PART ELEVATION

TYPICAL DOOR DETAILS
SCALE $\frac{3}{8}$ " = 1'-0"



HEAD

STEEL LINTELS
STEEL LINTELS AS SHOWN ABOVE SHALL CONSIST OF 2 ANGLES 3 1/2" x 3 1/2" x 5/8" AND SHALL BE EQUAL IN LENGTH TO THE WIDTH OF THE OPENING PLUS 10"

TYPICAL CONCRETE OR TILE MASONRY DETAILS

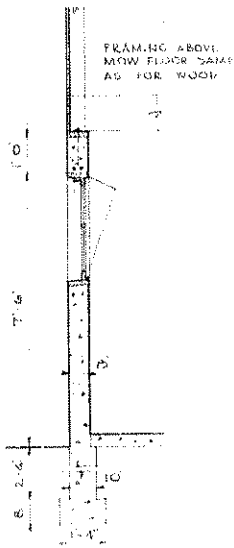

TYPICAL WALL SECTION
SCALE $\frac{3}{8}$ " = 1'-0"

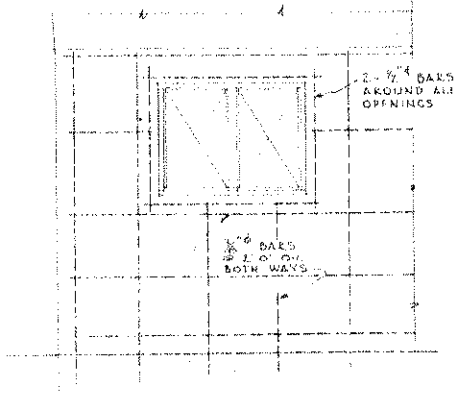

TYPICAL WALL ELEVATION
SCALE $\frac{3}{8}$ " = 1'-0"

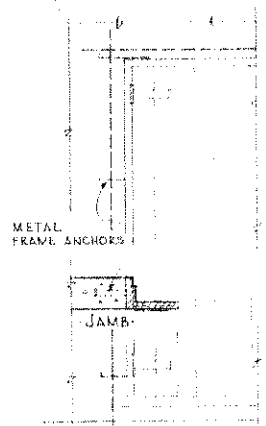

TYPICAL DOOR DETAILS
SCALE $\frac{3}{8}$ " = 1'-0"

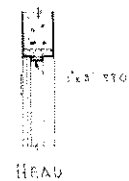

HEAD

ON ALL OPENINGS THE PLANK FRAME SHALL BE MADE FULL 8" WIDE AND TACKED IN PLACE IN THE FORMS BEFORE THE CONCRETE IS PLACED.

TYPICAL DETAILS FOR MONOLITHIC CONCRETE WALL

COOPERATIVE EXTENSION WORK IN
AGRICULTURE AND HOME ECONOMICS
STATE OF NORTH DAKOTA
NORTH DAKOTA AGRICULTURAL COLLEGE
AND
U.S. DEPT. OF AGRICULTURE COOPERATING
EXT. AGR'L ENGINEER-FARGO, N. DAK.
DAIRY BARN
HIGHWAY 53
78301-78311-78321 EX. 5260 SHEET 7 of 7